

EVJ 700

Application Manual:
Controller for horizontal
cooking modules

- | 4 cooking combinations (depending on the application): power or temperature + timer or needle probe
- | ON-OFF or PI temperature control
- | Models for managing external SSRs
- | Push encoder and/or 6 capacitive touch keys
- | 2.8" LCD colour graphic display
- | IP65 front protection
- | 2 installation methods on front panel: built-in or concealed under the panel (if made of glass or methacrylate) with customizable keys on the panel surface



USE

Device used for indoor applications.



IMPORTANT

Read this document carefully before installation and take all precautions before using the device. Only use the device in the ways described in this document.



CONSIDER THE ENVIRONMENT

Keep this document with the device for future reference. Please do not print out again.



DISPOSAL

The device must be disposed of according to local regulations governing the collection of electrical and electronic equipment.

Index

 Introduction	5
 Main features and purchasing codes	6
 Measurements and installation (mm)	7
 Electrical connections	9
 Navigation	12
Introduction	12
Keypad	12
Push encoder	12
Changing values	13
Power failure	13
Communication	13
Basic functions	14
Fans	14
Heating	14
Activating the buzzer when the setpoint is reached	14
 Main menu	15
Configuration screen	15
Setting password	15
Available menus	16
Configuration	16
Service	16
Language	16
Internal values	16
Restoring parameters	15
 Configuring inputs/outputs for the different applications	17
 Configurable applications	18
Electric hot plates	19
Ovens	21
Tilting pans	24

Boiling pans	28
Fry-tops	30
Grills	33
Fryers	35
Pasta cookers	39
Bain-marie	42
 Connectivity	45
EPoCA cloud platform	45
EVconnect mobile app	45
 List of alarms	46
Table of alarms	46
 Parameters	47
Managing parameters	47
Making changes using the EVJKEY	47
Table of parameters	46
 Accessories	54
List of accessories	54
 Technical specifications	55

Introduction

The **EVJ 700** compact controller is a modern alternative to electro-mechanical devices for managing horizontal cooking modules in professional kitchens. It offers maximum configurability as it can be used with nine different applications: electric hot plates, ovens, tilting pans, boiling pans, fry-tops, fryers, pasta cookers, bain-marie and grills.

Depending on the application, cooking can be controlled by power or temperature, combined with a timer or needle probe as required. Temperature can be ON-OFF or PI controlled for greater regulation precision.

The smart 2.8 inch LCD graphic display with 6 capacitive touch keys and/or a push encoder provides constant information about the processes in progress, as well as making it easy to set the cooking cycle.

Equipped with IP65 front protection, the controller can be fitted to the panel in the conventional way, built into the front, or concealed under the panel (if made of glass or methacrylate), ensuring high cleaning and hygiene standards.

Users can interact remotely with their equipment using the EPoCA® cloud platform with Wi-Fi or Ethernet connectivity (which also enables alternative or parallel control through MODBUS TCP). Onsite, they can interact from a mobile device with the EVconnect® app which uses Bluetooth Low Energy connectivity.



Main features and purchasing codes

The table below shows the main features and their purchasing codes

Features	EVJ705J9	EVJ705Z9	EVJ725J9	EVJ705J9VG
Power supply				
115... 230 VAC	•	•	•	•
Installation				
Recessed in the panel	•	•	•	
Concealed under the panel (if made of glass or metacrylate)				•
Analogue inputs				
Regulation probe (Pt 1000 2 wires)		•		
Regulation probe (J/K/Pt 100 2 wires)	•		•	•
Needle probe (Pt 1000 2 wires)		•		
Needle probe (J/K/Pt 100 2 wires)	•		•	•
Digital inputs				
Multi-purpose 1	•	•	•	•
Multi-purpose 2	•	•	•	•
Digital outputs (electro-mechanical relays, A res. at 250 VAC)				
Load 1 (configurable)	16 A	16 A	16 A	16 A
Load 2 (configurable)	5 A	8 A		5 A
Load 4 (configurable)	8 A	8 A	8 A	8 A
Load 5 (configurable)	8 A	5 A	8 A	8 A
Load 6 (configurable)	5 A	5 A		5 A
Digital outputs (command for solid state relays; 12 VDC, 15 mA max)				
Load 2 (configurable)			•	
Load 6 (configurable)			•	
User interface				
2.8 inch graphic display	•	•	•	•
Communications ports				
TTL MODBUS	•	•	•	•
For encoder	•	•	•	•
Connectivity				
RS-485 MODBUS RTU (optional through the EVlinking RS-485 module)	•	•	•	•
Bluetooth Low Energy for EVconnect app (optional through the EVlinking BLE module)	•	•	•	•
Wi-Fi EPoCA/MODBUS TCP (optional through the EVlinking Wi-Fi module powered by controller)	•	•	•	•
Ethernet EPoCA/MODBUS TCP (optional through the controller/gateway EV3 Web)	•	•	•	•
Further features				
Alarm buzzer	•	•	•	•
ON-OFF/PI control	•	•	•	•

For more information see the section "Technical specifications".

Measurements and installation (mm)



INSTALLATION PRECAUTIONS

- Ensure that the working conditions are within the limits stated in the "Technical specifications" section.
- Do not install the device close to heat sources, equipment with a strong magnetic field, in places subject to direct sunlight, rain, damp, excessive dust, mechanical vibrations or shocks.
- In compliance with safety regulations, the device must be installed properly to ensure adequate protection from contact with electrical parts. All protective parts must be fixed in such a way as to need the aid of a tool to remove them.

Models for built-in installation.

Front installation on a plastic or metal panel (with elastic holding flaps).

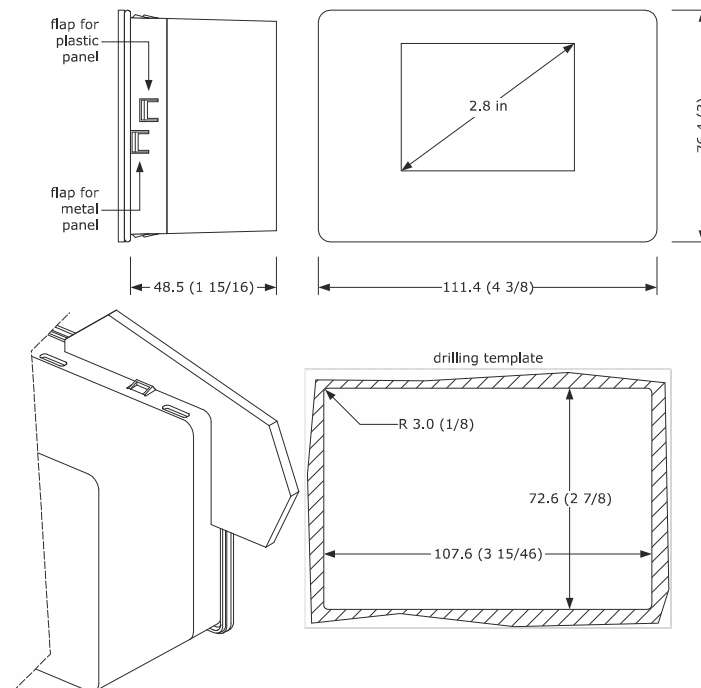

N.B.
The metal panel must be between 0.8 and 1.5 mm (1/32 and 1/16 in) thick, while the plastic panel must be between 0.8 and 3.4 mm (1/32 and 1/8 in).

Models for concealed installation under the panel

Installation from behind on a glass or methacrylate panel (with double-sided adhesive tape) personalising the keys on the front of the unit.

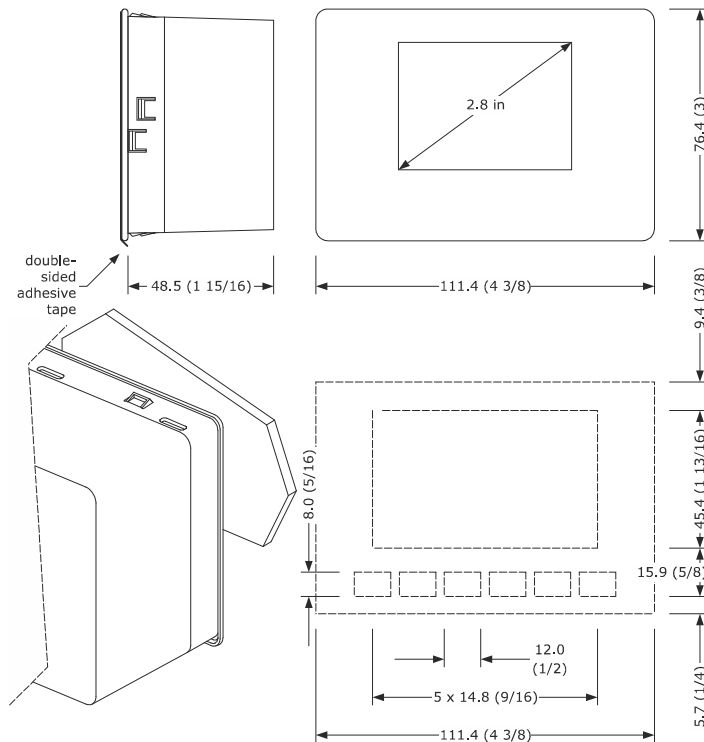

- N.B.
- the maximum thickness of a glass panel must be 4.0 mm (3/16 in), while that for a methacrylate panel must be 2.0 mm (1/16)
 - the panel and the material used to carry out screen printing must not contain conductive substances
 - keep the device and the panel at a temperature of between 15 and 38°C (59 and 100°F) for about an hour before carrying out the installation
 - before installation, carefully clean the panel surface that will be in contact with the double-sided adhesive tape, making sure that the product used for cleaning is suitable for the panel material (we recommend using isopropyl alcohol, in the case of surfaces greased with a hydrocarbon solvent). Continue cleaning with a cloth until it is clean and dry after use
 - during installation, apply uniform and constant pressure for about 30 seconds on the panel surface in contact with the double-sided adhesive tape. Then leave the device and the panel in a horizontal position for about 48 hours at a temperature of between 15 and 38°C (59 and 100°F).

Electrical connections



PRECAUTIONS FOR ELECTRICAL CONNECTIONS

- Use cables of an adequate section for the current running through them
- To reduce any electromagnetic interference, locate the power cables as far away as possible from the signal cables
- If using an electrical or pneumatic screwdriver, adjust the tightening torque
- If the device is moved from a cold to a warm place, humidity may cause condensation to form inside; wait for about an hour before switching on the power
- Make sure that the supply voltage, electrical frequency and power are within the set limits
- Disconnect the power supply before carrying out any type of maintenance
- Do not use the device as a safety device
- For repairs and further information, contact the EVCO sales network; returned goods without the data label will not be accepted

Electrical connection model EVJ705Z9

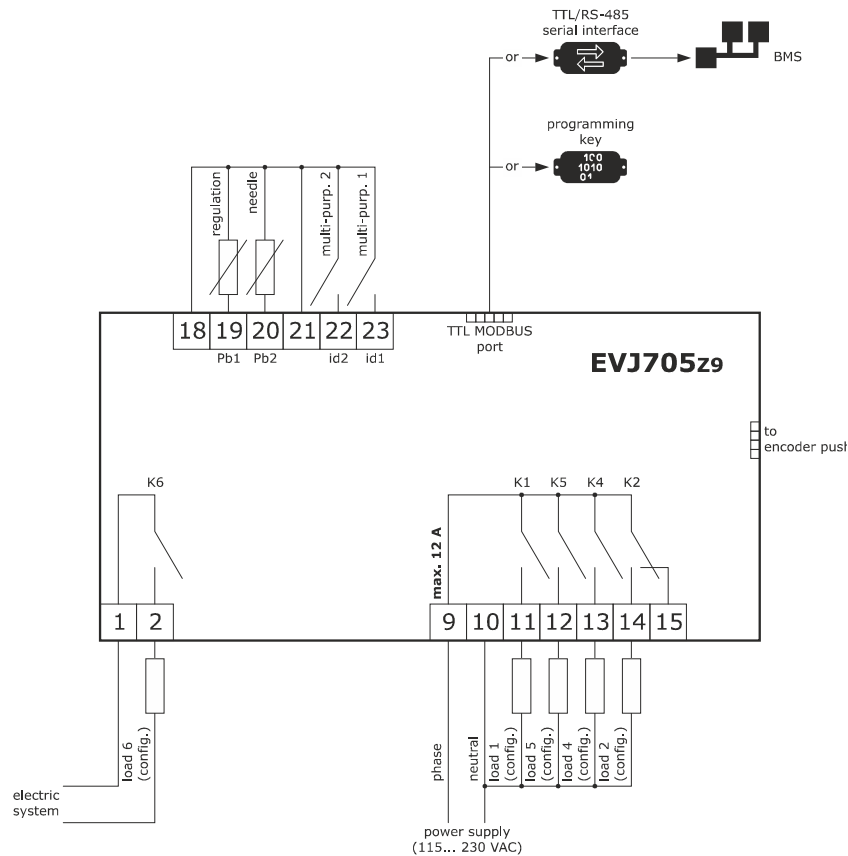

Electrical connection model EVJ705J9 and EVJ705J9VG

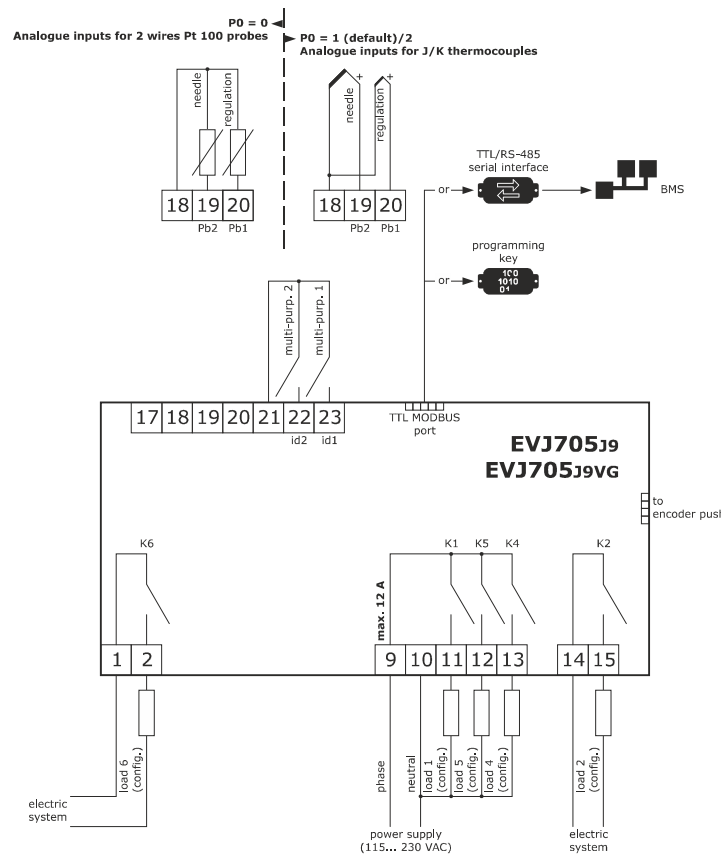

Electrical connection model EVJ725J9

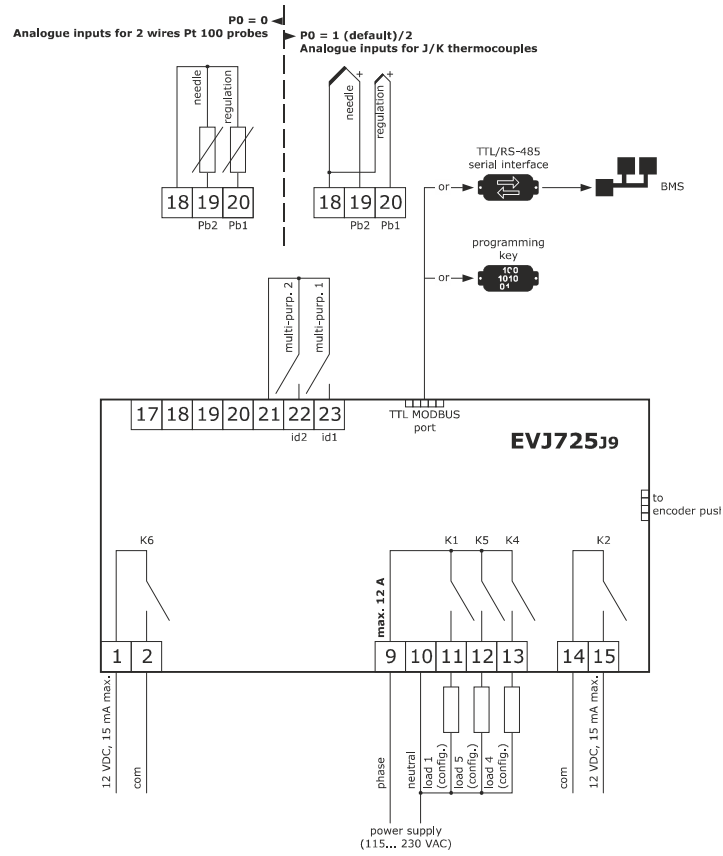

Navigation

Introduction

The controllers in the EVJ 700 range have 6 capacitive keys and a push encoder (optional). All the functions can be activated by both the keys and the encoder. Later sections in this manual will describe the platform used for each of the 9 available applications in detail, while the normal navigation and configuration procedures are illustrated below.

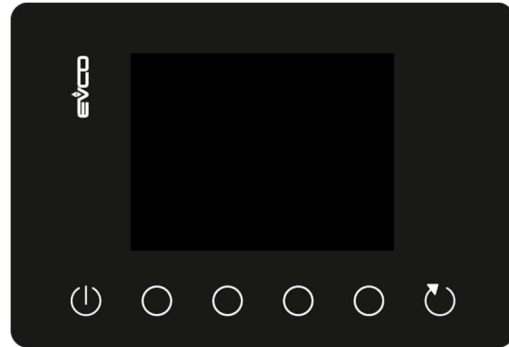

Keypad

The keypad has 6 capacitive keys; 2 have set functions (ON-OFF and REFRESH), while 4 have functions which vary according to the menu the user is in. Pressing a "function" key enables the function indicated on the icon above the key.



ON-OFF

Pressing this key for 2 seconds switches the controller on/off



REFRESH

At the end of the countdown, pressing this key will refresh the time previously set on the selected timer



FUNCTION

Depending on the application activated, the four function keys are used to select:

- type of cooking
- temperature setpoint
- heating power
- cooking time

Once the function has been selected (e.g. the timer), the relative icon goes from grey to white, as does the value which is to be modified.

If a value needs to be changed from the keypad, the function keys are momentarily used as icons "-", "+", "SET".

Push encoder

The functions can also be selected using the encoder by simply pressing the push button. When the icons are selected, they change colour:

- grey not selected
- white selected and ready to be modified

The value of the selected function is changed by turning the encoder clockwise or anticlockwise.

Encoder purchasing codes

- EVC99C00X0XXX03 Encoder push soft torque
- EVC99C00X0XXX04 Encoder push heavy torque

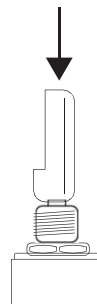

PUSH

to choose the desired function

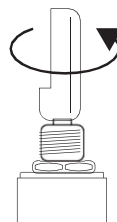

TURN

to change the chosen value

Changing values

Values can be changed either by using the keypad or the push encoder.

- Keypad:
Select the desired function, the value will become white. Press one of the function keys on the monitor and the "-", "+", "SET" values will appear. The value can be increased or decreased by pressing the relative key and then confirmed with the "SET" key.
- Push encoder:
Select the desired function by pressing the push button on the encoder. The value will become white. Turn the encoder to set the value and press the push button once again to confirm.

If neither of these two procedures are carried out within 5 seconds, the controller will automatically save the displayed value.

The display will return to the ON screen:

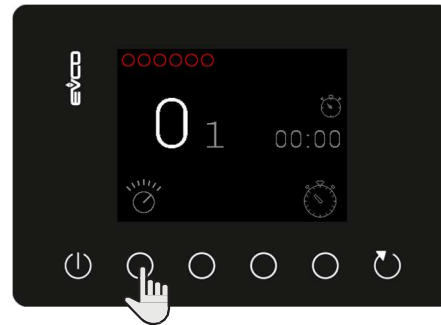

Function
Select the function

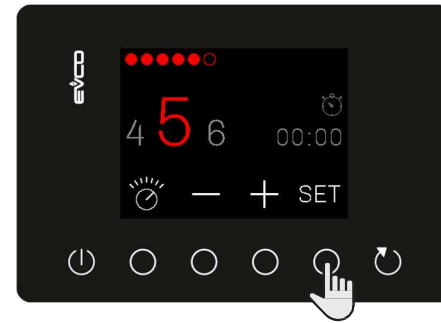

VALUE
change the value using the "-", "+", "SET" keys

Power failure

In the event of a power failure during normal operation, the controller will start working again according to the configuration of parameter "A13".

Communication

The following products can be connected through the TTL port:

- EVJKEY (programming key)
- EVIF22TSX (TTL/RS-485 serial interface)

Basic functions

The following basic functions are available for all the configurations.

Technical room fans (only for models with J/K thermocouples)

When the temperature recorded by the on-board probe exceeds the threshold set by parameter "r37", the relay configured as "Fans" is activated.

The hysteresis to deactivate the relay is set at 2°C.

If one of the relays is set as "Fans" but there is no on-board probe or there is a probe error, the relay will always be active.

When the heating output is active (either in power-controlled and in temperature-controlled models), the icon  will be displayed in the top-left corner.

Heating

When regulation is managed with a temperature setpoint, the relay output for the heaters can be managed by conventional or PI-type regulation.



Activating the buzzer when the setpoint is reached

For applications with temperature regulation, the first time the setpoint regulation temperature is reached (including the MELT function), the buzzer will sound according to the configuration set by parameter "e2".

The buzzer will work with the same logic as the "green light" which indicates the setpoint has been reached.

Main menu

Once the controller has been connected to the power supply, the OFF screen will be displayed.

- The main screen is accessed by pressing the  function key on the **OFF** screen.
- The configuration screen is accessed by pressing the  function key on the OFF screen.

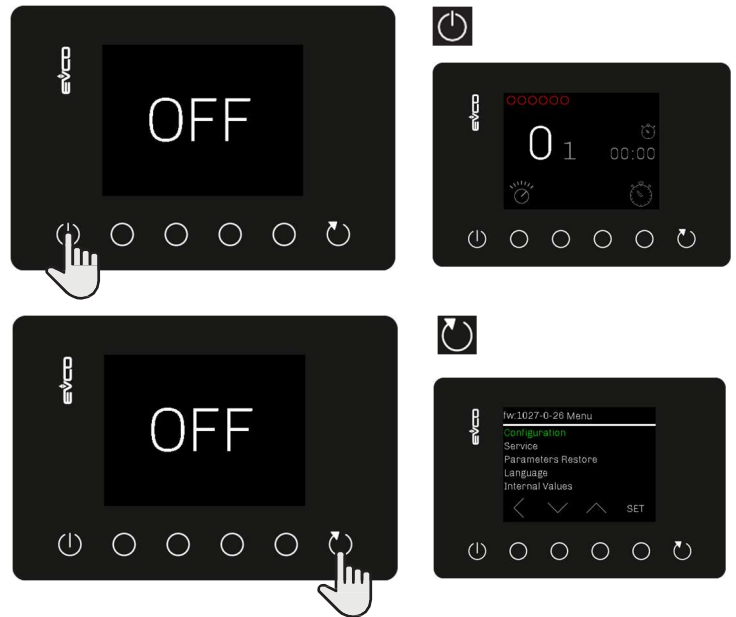

Configuration screen

From the configuration screen, it is possible to choose the controller settings from various different menus.

To choose the menu to change, select it by pressing the  function keys corresponding to the "UP" and "DOWN" arrows. The writing will become white when selected. Press the "SET" function key to confirm.

Setting the password

Some of the menus in the configuration screen require a password to be entered to be changed:

- **"Configuration"**: allows the user to configure the type of application to be managed by the controller
- **"Service"**: manages the parameters
- **"Restore parameters"**: reloads the default values (except the PAS and P0 parameters); the password is "149".

Once the **"Configuration"** menu has been selected, the password must be entered.

Press the  function keys corresponding to the "UP" and "DOWN" arrows to set the password, then press the "SET" function key to confirm.

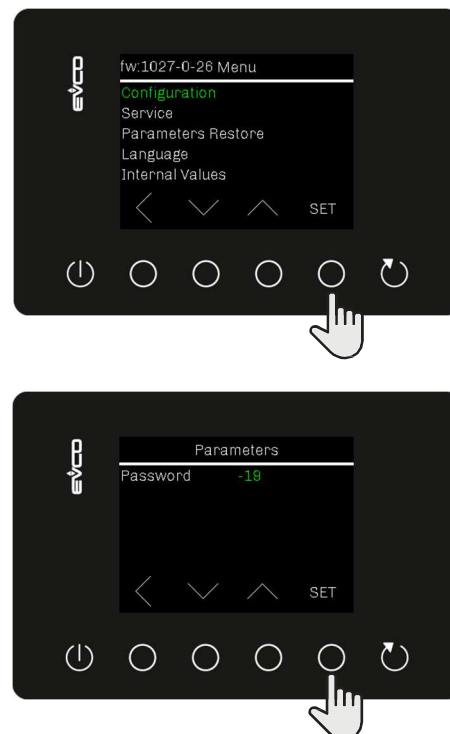

Available menus

The following menus are available on the configuration screen:

- Configuration
- Service
- Language
- Internal values
- Restore parameters

Configuration

In this menu it is possible to set the application to be managed using the controller through the dedicated parameter "e1".

Once the application has been selected, the relative default parameters will be automatically uploaded.

Service

Parameters can be displayed and changed in this menu.

The complete list of the parameters with their labels, descriptions and values can be found in the section "Table of parameters". After entering the password, the complete list of parameters will appear on the screen.

The parameters to change can be selected by pressing the  function keys corresponding to the "UP" and "DOWN" arrows and then the "SET" function key to confirm.

Language

The required language can be chosen in this menu:

- Italian
- English
- French
- German
- Spanish

The language to set can be selected by pressing the  function keys corresponding to the "UP" and "DOWN" arrows and then the "SET" function key to confirm.

Internal values

The status of the inputs and outputs available for the application in use can be viewed in this menu:

- Probes
- Digital inputs

Restore parameters

The parameter values can be restored in this menu, restoring the controller to the factory settings.

Configuring inputs/outputs for the different applications

The basic configuration of the inputs/outputs for each individual application is as follows:

I/O	No application	Electric hot plates	Bain-marie	Tilting pans	Boiling pans	Fry-tops	Cast iron grills	Fryers	Pasta cookers	Ovens
Analogue inputs										
Regulation probe			√	√		√		√		√
Needle probe				√		√				√
Digital inputs										
id1		√	LEVEL SENSOR	DOOR SWITCH	√	√	√	√	√	√
id2		√	√	√	√	√	√	√	√	√
Other inputs										
Push encoder			√	√	√	√	√	√	√	√
Digital outputs										
K1		HEATING ELEMENT	HEATING ELEMENT	HEATING ELEMENT	HEATING ELEMENT	HEATING ELEMENT	HEATING ELEMENT	HEATING ELEMENT	HEATING ELEMENT	TOP HEATING ELEMENT
K2			H ₂ O CHARGE VALVE	H ₂ O CHARGE VALVE	COLD H ₂ O VALVE	AUXILIARY RELAY		MOTOR-DRIVEN BASKET 1	H ₂ O FAST CHARGE VALVE	BOTTOM HEATING ELEMENT
K4		TECHNICAL ROOM FANS	H ₂ O DISCHARGE VALVE	TECHNICAL ROOM FANS	HOT H ₂ O VALVE	TECHNICAL ROOM FANS	TECHNICAL ROOM FANS	TECHNICAL ROOM FANS	H ₂ O SLOW CHARGE VALVE	TECHNICAL ROOM FANS
K5		ON-OFF	ON-OFF	ON-OFF	ON-OFF	ON-OFF	ON-OFF	ON-OFF	ON-OFF	ON-OFF
K6			TECHNICAL ROOM FANS		TECHNICAL ROOM FANS			MOTOR-DRIVEN BASKET 2	TECHNICAL ROOM FANS	

Configurable applications

The controller firmware can manage up to nine different applications. The desired application can be enabled using parameter "e1" as per the following list:

- 0 = "None"
- 1 = "Electric hot plates"
- 2 = "Bain-marie"
- 3 = "Tilting pans"
- 4 = "Boiling pans"
- 5 = "Fry-Tops"
- 6 = "Cast iron grills"
- 7 = "Fryers"
- 8 = "Pasta cookers"
- 9 = "Ovens"

Electric hot plates

Inputs available

- Push encoder
- Technical room fans
- ON-OFF

Outputs available

- Heater

Information displayed

The display shows the power value and the cooking time.

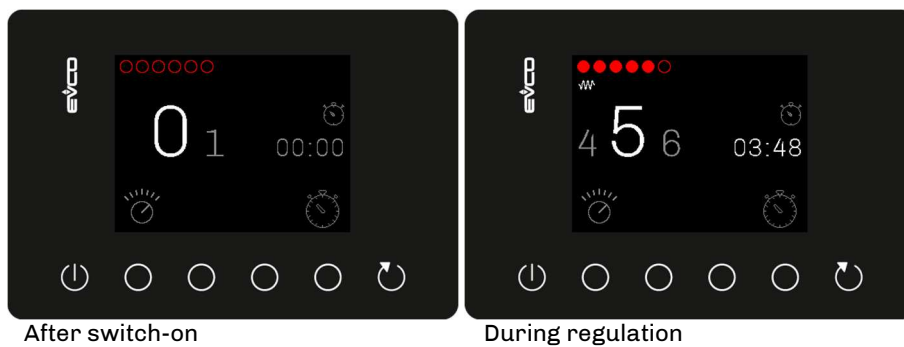

Available functions



Device ON/OFF

When the display is switched on, the default values are loaded:

Power: 0

Time: 00:00mm:ss



Power regulation:

Selection interval: [0<->6]



Selection of cooking time

Selection range: [00:00<->59:59 mm:ss]



Refresh

This reloads the last time value set on the selected timer

Operation

- All the functions listed above can be selected using the function keys or the push encoder, as described in the general introduction.
 - During setting, the value to change will flash.
The hours/minutes or minutes/seconds on the timer are modified separately.
If confirmation is not given within 5 seconds, it will automatically validate the displayed value.
- The controller begins regulation when the value of the energy regulator is anything other than "0", based on the regulation value set by the relative parameters:
 - Regulator 1: 2" (r19) ON/10" (r20) OFF
 - Regulator 2: 4" (r21) ON/10" (r22) OFF
 - Regulator 3: 6" (r23) ON/10" (r24) OFF
 - Regulator 4: 8" (r25) ON/10" (r26) OFF
 - Regulator 5: 10" (r27) ON/10" (r28) OFF
 - Regulator 6: 12" (r29) ON/10" (r30) OFF
- Heating is interrupted when the power regulator is set with a value of "0" or when the controller is switched OFF.
- At the end of the countdown (when the time is 00:00), the buzzer will sound until the button on the push encoder (or one of the six function keys) is pressed or until the timeout interval set by the relative parameter (e2) elapses, with a cycle of 0.5 "ON/0.5" OFF. This does not affect the regulation, the device will continue normal regulation.

Management of technical room fan output and ON-OFF output

- If one of the available outputs is configured as "technical room fans" (value set to 11), the fans are always on (except for models with J/K thermocouples, where they are activated when the threshold set by parameter r37 is exceeded).
-
- If one of the available outputs is configured as "ON-OFF" (value set to 14), the relay will operate as follows:
 - OFF when the device is on stand-by mode
 - ON under all other conditions

Ovens

Inputs available

- Regulation probe
- Needle probe
- Push encoder

Outputs available

- Bottom heater
- Top heater
- Technical room fans
- ON-OFF

Information displayed

The display shows the cooking time and, depending on the type of cooking selected, the temperature of the regulation probe or the needle probe. The temperature can refer to the reading or the setpoint, depending on how parameter "e4" is set.

Below is an example of the display when timed cooking has been selected.

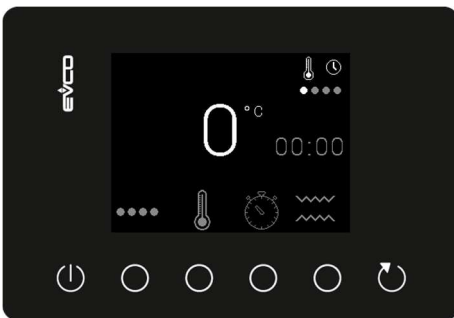

Switch-on screen

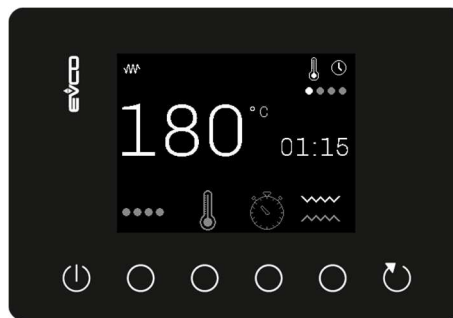

Regulation screen

Available functions



Device ON/ OFF

When the display is switched on, the following values are uploaded:

Type of cooking: last cooking selected:

Temperature: 0

Time: 00:00

Selection of type of cooking

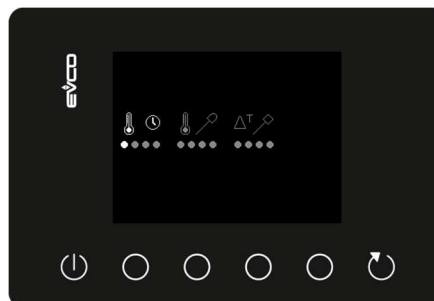
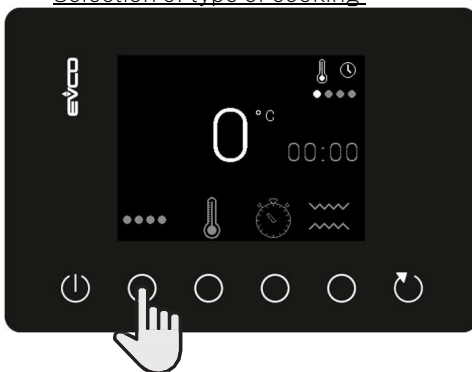

Time: regulation is time-controlled



ΔT : regulation is determined by the difference between the temperature of the needle probe and that of the regulation probe



Needle: regulation is determined by the temperature of the needle

Setting the setpoint

Only the settable values are displayed, according to the type of cooking selected.

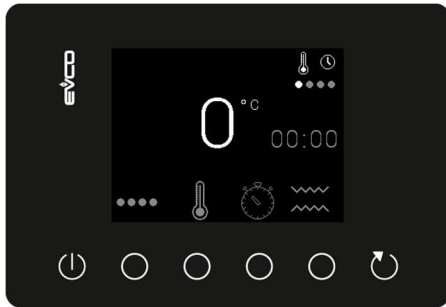

Timed cooking

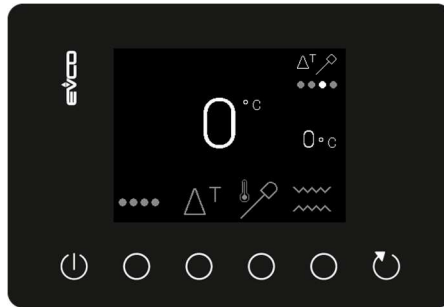

ΔT cooking

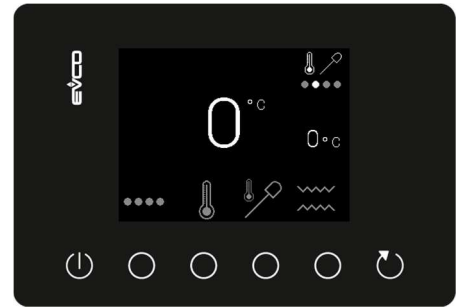

Needle cooking

The selection ranges/intervals for each value are the following:



Temperature of regulation probe [0 <-> 300°C]



Temperature of ΔT [0 <-> 150°C]



Time [00:00 <-> 24:00 hh:mm]



Temperature of needle probe [0 (r4) <-> 99 (r5) °C]

Selection of heaters:



Top heaters on



Bottom heaters on



Top + bottom heaters on



Refresh

This reloads the last time value set on the selected timer

Operation

- All the functions listed above can be selected using the function keys or the push encoder, as described in the general introduction.
 - During setting, the value to change will flash.
The hours/minutes or minutes/seconds on the timer are modified separately.
If confirmation is not given within 5 seconds, it will automatically validate the displayed value.
- Except for ΔT mode, the controller heats when the value of the regulation probe is lower than the set value. It interrupts heating when the value exceeds it. Heating is restored when the value goes below the set value again. Regulation continues until the regulator is switched OFF.
- Heating in ΔT mode:
cooking continues until the temperature detected by the needle probe reaches the core setpoint. Once it has reached this setpoint, the heating relay is deactivated.
The working setpoint is relative to the temperature detected by the needle probe, that is "*temperature detected by the needle probe + Delta T setpoint*"
- When the set temperature is reached, a warning icon  will appear on the screen.
The icon will disappear only when the temperature setpoint is changed or the controller switched off.
- Heating is interrupted when the controller is switched off.
- When the needle temperature is reached or the countdown ends (time at 00:00), the buzzer will sound until the button on the push encoder (or one of the 6 function keys) is pressed or until the timeout interval set by the relative parameter (e2) elapses, with a cycle of 0.5 "ON/0.5" OFF. This does not affect the regulation, the device will continue normal regulation.

Management of technical room fan output and ON-OFF output

- If one of the available outputs is configured as "technical room fans" (value set to 11), the fans are always on (except for models with J/K thermocouples, where they are activated when the threshold set by parameter r37 is exceeded).
- If one of the available outputs is configured as "ON-OFF" (value set to 14), the relay will operate as follows:
 - OFF when the device is on stand-by mode;
 - ON under all other conditions.

Tilting pans

Inputs available

- Regulation probe
- Needle probe
- Push encoder
- Door switch

Outputs available

- Heater
- Water loading solenoid valve
- Technical room fans
- ON-OFF

Information displayed

Depending on the type of cooking selected, the values that can be displayed are: time, power, regulation probe temperature or needle probe temperature. The temperature can refer to the reading or the setpoint, depending on how parameter "e4" is set.

Below is an example of the display when timed cooking has been selected.

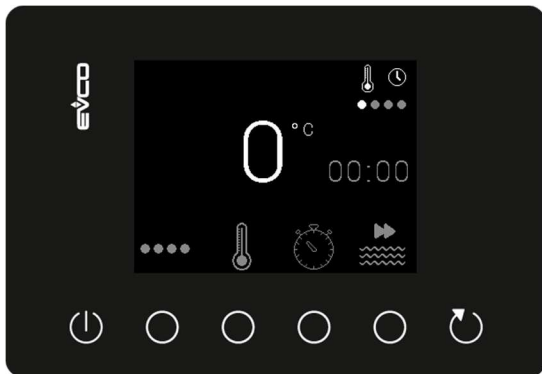

Available functions



Device ON/OFF

When the display is switched on, the following values are uploaded:

Type of cooking: last cooking selected

Temperature: 0

Time: 00:00

Power regulator: 0

Selection of type of cooking

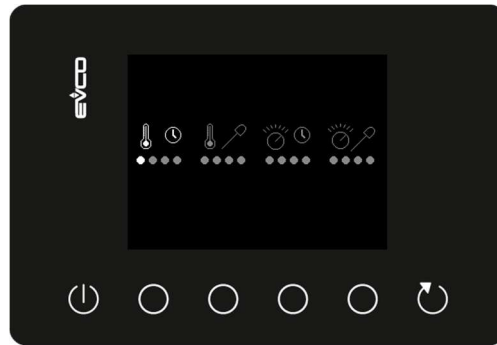
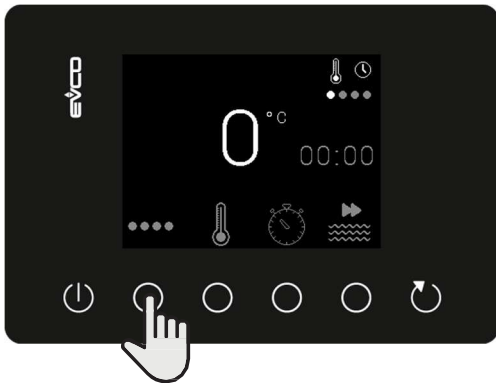

Temperature-Time:
regulation is carried out taking into consideration the temperature setpoint of the regulation probe and a signal based on a timer count



Temperature-Needle:
regulation is carried out taking into consideration the temperature setpoint of the regulation probe and a signal based on the needle probe setpoint



Power-Time:
regulation is carried out taking into consideration the value of the regulation power and a signal based on a timer count



Power-Needle:
regulation is carried out taking into consideration the value of the regulation power and a signal based on the setpoint of the needle probe

Setting the setpoint:

Only the settable values are displayed, according to the type of cooking selected.



Temperature-Time Cooking

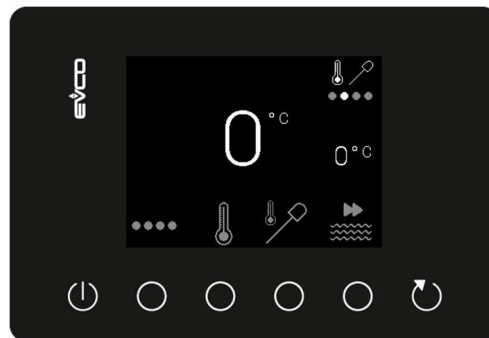

Temperature-Needle Cooking

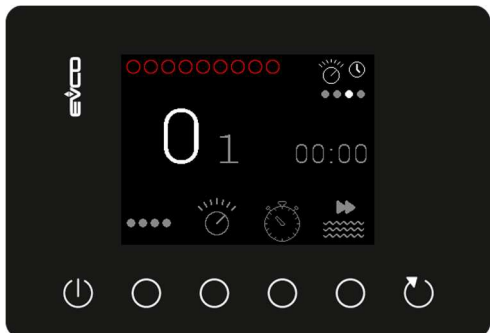

Power-Time Cooking

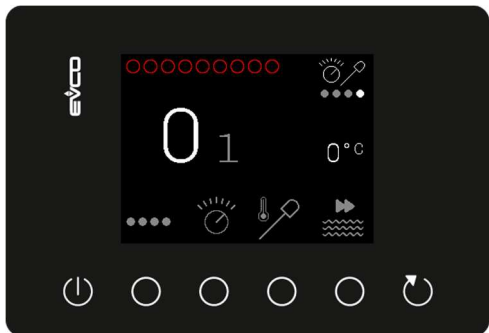

Power-Needle Cooking

The selection ranges/intervals for each value are the following:



Temperature of regulation probe [0 <-> 300°C]



Regulation power [0 <-> 9]



Time [00:00 <-> 24:00 hh:mm]



Temperature of needle probe [0 (r4) <-> 99 (r5) °C]



Water filling:

activation/deactivation of the solenoid valve to fill the tank.

This key works in a similar way to a switch, the solenoid valve is activated when it is pressed. When it is pressed again, the solenoid valve is deactivated ("toggle" switch).

To activate it, the key must be held down for 3 seconds, whereas deactivation is immediate.

When the function is active, the icon flashes

When the function is deactivated, the icon stays on



Refresh

This reloads the last time value set on the selected timer

Operation

- All the functions listed above can be selected using the function keys or the push encoder, as described in the general introduction.
 - During setting, the value to change will flash.
The hours/minutes or minutes/seconds on the timer are modified separately.
If confirmation is not given within 5 seconds, it will automatically validate the displayed value.
- Water filling
 - If water filling is active, the solenoid valve will also be activated
 - If water filling is deactivated, the solenoid valve will also be deactivated
- Heating
 - The controller begins heating when the value of the regulation probe is lower than the set value; heating will be interrupted when the value is higher. Heating is restored in the same way, when the value goes down again.
 - When the set temperature is reached, a warning icon  will appear on the screen.
The icon will disappear only when the temperature setpoint is changed or the controller switched OFF.
 - The controller begins regulation when the value of the energy regulator is anything other than "0", based on the regulation value set by the relative parameters:
 - Regulator 1: 3° ON (r19)/45° OFF (r20)
 - Regulator 2: 4° ON (r21)/38° OFF (r22)
 - Regulator 3: 5° ON (r23)/32° OFF (r24)
 - Regulator 4: 7° ON (r25)/29° OFF (r26)
 - Regulator 5: 9° ON (r27)/30° OFF (r28)
 - Regulator 6: 13° ON (r29)/32° OFF (r30)
 - Regulator 7: 21° ON (r31)/37° OFF (r32)
 - Regulator 8: 45° ON (r33)/60° OFF (r34)
 - Regulator 9: 100% ON (r35/r36)
- If the door is open, the controller will deactivate all the outputs as a safety measure.
- Heating is interrupted when the power regulator is set with a value of "0" or when the controller is switched OFF.
- When the needle temperature is reached or the countdown ends (time at 00:00), the buzzer will sound until the button on the push encoder (or one of the 6 function keys) is pressed or until the timeout interval set by the relative parameter (e2) elapses, with a cycle of 0.5 "ON/0.5" OFF. This does not affect the regulation, the device will continue normal regulation.

Management of technical room fan output and ON-OFF output

- If one of the available outputs is configured as "technical room fans" (value set to 11), the fans are always on (except for models with J/K thermocouples, where they are activated when the threshold set by parameter r37 is exceeded).
-
- If one of the available outputs is configured as "ON-OFF" (value set to 14), the relay will operate as follows:
 - OFF when the device is on stand-by mode
 - ON under all other conditions

Boiling pans

Inputs available

- Push encoder

Outputs available

- Heater
- Hot water solenoid valve
- Cold water solenoid valve
- ON-OFF
- Technical room fans

N.B.: solenoid valves can never be activated at the same time

Information displayed

The display shows the power value and the cooking time.

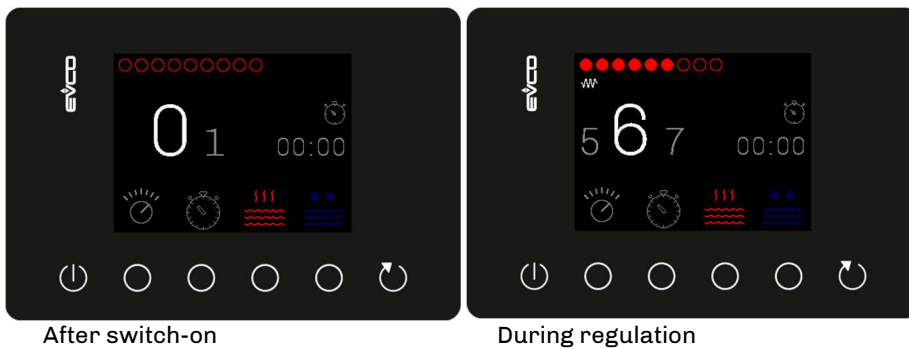

Available functions



Device ON/OFF

When the display is switched on, the following values are uploaded:

Power: 0

Timer time 00:00 hh:mm



Power regulation:

Selection interval: [0<->9]



Selection of cooking time

Selection range: [00:00<->23:59 hh:mm]



Hot water filling

activation/deactivation of the solenoid valve to fill the tank.

This key works in a similar way to a switch, the solenoid valve is activated when it is pressed. When it is pressed again, the solenoid valve is deactivated ("toggle" switch).

To activate it, the key must be held down for 3 seconds, whereas deactivation is immediate.

When the function is active, the icon flashes.

When the function is deactivated, the icon stays on.

**Cold water filling**

activation/deactivation of the solenoid valve to fill the tank.

This key works in a similar way to a switch, the solenoid valve is activated after it is pressed. When it is pressed again, the solenoid valve is deactivated ("toggle" switch).

To activate it, the key must be held down for 3 seconds, whereas deactivation is immediate.

When the function is active, the icon flashes.

When the function is deactivated, the icon stays on.

**Refresh**

This reloads the last time value set on the selected timer

Operation

- All the functions listed above can be selected using the function keys or the push encoder, as described in the general introduction.
 - During setting, the value to change will flash.
The hours/minutes or minutes/seconds on the timer are modified separately.
If confirmation is not given within 5 seconds, it will automatically validate the displayed value.

- The controller begins regulation when the value of the energy regulator is anything other than "0", based on the regulation value set by the relative parameters:
 - Regulator 1: 3" ON (r19)/45" OFF (r20)
 - Regulator 2: 4" ON (r21)/38" OFF (r22)
 - Regulator 3: 5" ON (r23)/32" OFF (r24)
 - Regulator 4: 7" ON (r25)/29" OFF (r26)
 - Regulator 5: 9" ON (r27)/30" OFF (r28)
 - Regulator 6: 13" ON (r29)/32" OFF (r30)
 - Regulator 7: 21" ON (r31)/37" OFF (r32)
 - Regulator 8: 45" ON (r33)/60" OFF (r34)
 - Regulator 9: always ON (r35/r36)

- Heating is interrupted when the power regulator is set with a value of "0" or when the controller is switched OFF.

- When countdown ends (time at 00:00), the buzzer will sound until the button on the push encoder (or one of the 6 function keys) is pressed or until the timeout interval set by the relative parameter (e2) elapses, with a cycle of 0.5 "ON/0.5" OFF. This does not affect the regulation, the device will continue normal regulation.

Management of technical room fan output and ON-OFF output

- If one of the available outputs is configured as "technical room fans" (value set to 11), the fans are always on (except for models with J/K thermocouples, where they are activated when the threshold set by parameter r37 is exceeded).

-

- If one of the available outputs is configured as "ON-OFF" (value set to 14), the relay will operate as follows:
 - OFF when the device is on stand-by mode
 - ON under all other conditions

Fry-tops

Inputs available

- Regulation probe
- Needle probe
- Push encoder

Outputs available

- Heater
- Auxiliary relay
- Technical room fans
- ON-OFF

Information displayed

Depending on the type of cooking selected, the values that can be displayed are: time, regulation probe temperature or needle probe temperature. The temperature can refer to the reading or the setpoint, depending on how parameter "e4" is set.

Below is an example of the display when timed cooking has been selected.

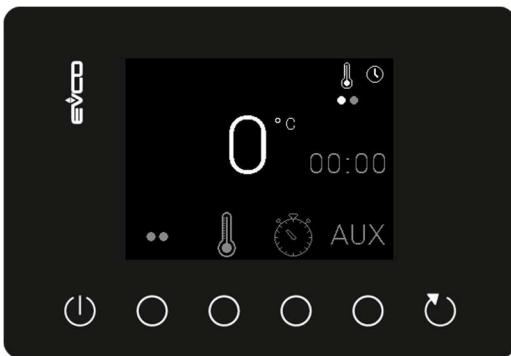

Available functions



Device ON/OFF

When the display is switched on, the following values are uploaded:
 Type of cooking: the last selected
 Temperature of regulation probe and/or needle: 0
 Time: 00:00

Selection of type of cooking

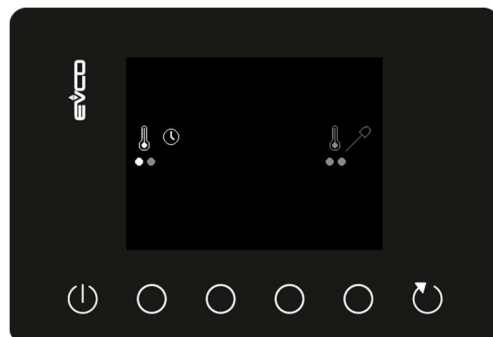
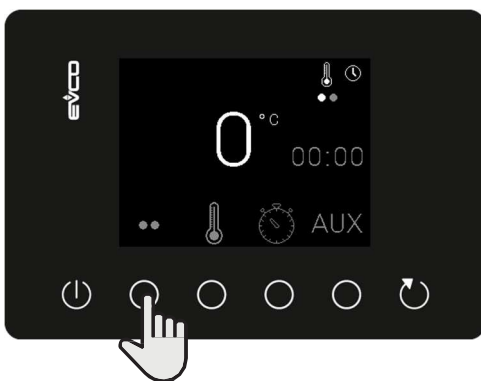

Time: regulation is time-controlled

Needle: regulation is determined by the temperature of the needle

Setting the setpoint

Only the settable values are displayed, according to the type of cooking selected.

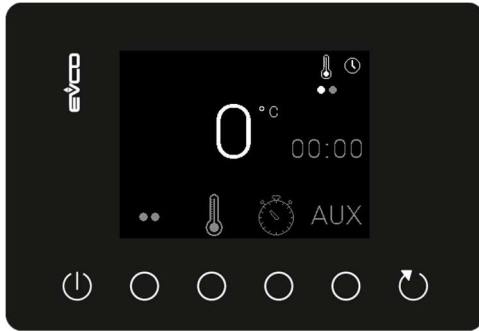

Timed cooking

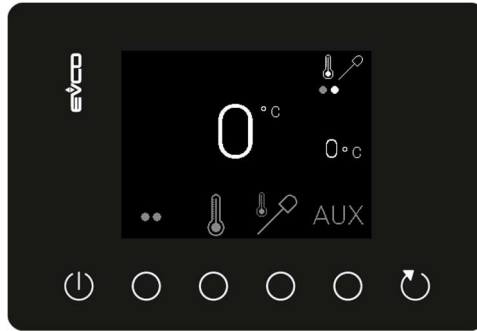

Needle cooking

The selection ranges/intervals for each value are the following:



Temperature of regulation probe [0 <-> 300°C]



Time [00:00 <-> 59:59 mm:ss]



Temperature of needle probe [0 (r4) <-> 99 (r5) °C]



Auxiliary relay

It makes it possible to manually modify the relay status (see paragraph "Management of the auxiliary relay")



Refresh

This reloads the last time value set on the selected timer



Operation

- All the functions listed above can be selected using the function keys or the push encoder, as described in the general introduction.
 - During setting, the value to change will flash.
The hours/minutes or minutes/seconds on the timer are modified separately.
If confirmation is not given within 5 seconds, it will automatically validate the displayed value.
- The unit begins heating when the value of the regulation probe is lower than the set value; heating will be interrupted when the value is higher. Heating is restored in the same way, when the value goes down again.
- When the set temperature is reached, a warning icon  will appear on the screen.
The icon will disappear only when the temperature setpoint is changed or the controller switched off.
- The device will interrupt heating when switched OFF.
- When the needle temperature is reached or the countdown ends (time at 00:00), the buzzer will sound until the button on the push encoder (or one of the 6 function keys) is pressed or until the timeout interval set by the relative parameter (e2) elapses, with a cycle of 0.5 "ON/0.5" OFF. This does not affect the regulation, the device will continue normal regulation.

Management of technical room fan output and ON-OFF output

- If one of the available outputs is configured as "technical room fans" (value set to 11), the fans are always on (except for models with J/K thermocouples, where they are activated when the threshold set by parameter r37 is exceeded).
-
- If one of the available outputs is configured as "ON-OFF" (value set to 14), the relay will operate as follows:
 - OFF when the device is on stand-by mode
 - ON under all other conditions

Management of the auxiliary relay

- If one of the available outputs is configured as "AUX" (value set to 15), the label "AUX" will be displayed above the fourth function key (otherwise it is not displayed).
- The color is grey when the relay is ON  and switches to green when the relay is OFF .
- The relay status can be changed touching the fourth function key or through the push-encoder as described in the introduction

Grills

The display shows the value of the power regulator selected and the cooking time.

Inputs available

- Push encoder

Outputs available

- Heater
- Technical room fans
- ON-OFF

Information displayed

The display shows the power value and the cooking time.

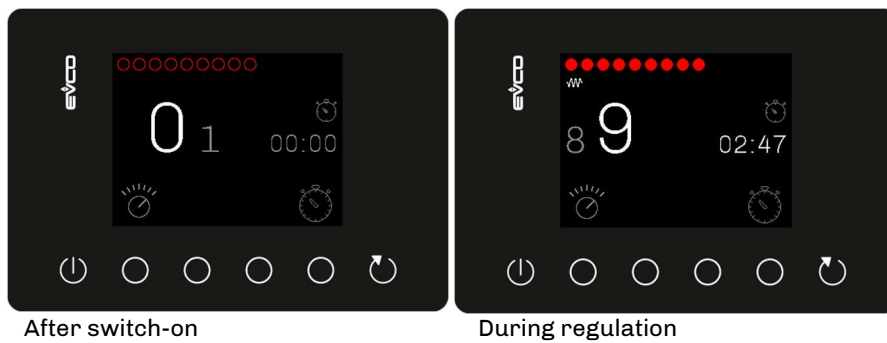

Available functions



Device ON/OFF

When the display is switched on, the following values are uploaded:

Power: 0

Time: 00:00mm:ss



Power regulation:

Selection interval: [0<->9]



Selection cooking time

Selection range: [00:00<->59:59 mm:ss]



Refresh

This reloads the last time value set on the selected timer

Operation

- All the functions listed above can be selected using the function keys or the push encoder, as described in the general introduction.
 - During setting, the value to change will flash.
The hours/minutes or minutes/seconds on the timer are modified separately.
If confirmation is not given within 5 seconds, it will automatically validate the displayed value.
- The controller begins regulation when the value of the energy regulator is anything other than "0", based on the regulation value set by the relative parameters:
 - Regulator 1: 3" ON (r19)/45" OFF (r20)
 - Regulator 2: 4" ON (r21)/38" OFF (r22)
 - Regulator 3: 5" ON (r23)/32" OFF (r24)
 - Regulator 4: 7" ON (r25)/29" OFF (r26)
 - Regulator 5: 9" ON (r27)/30" OFF (r28)
 - Regulator 6: 13" ON (r29)/32" OFF (r30)
 - Regulator 7: 21" ON (r31)/37" OFF (r32)
 - Regulator 8: 45" ON (r33)/60" OFF (r34)
 - Regulator 9: always ON (r35/r36)
- Heating is interrupted when the power regulator is set with a value of "0" or when the controller is switched OFF.
- When countdown ends (time at 00:00), the buzzer will sound until the button on the push encoder (or one of the 6 function keys) is pressed or until the timeout interval set by the relative parameter (e2) elapses, with a cycle of 0.5 "ON/0.5" OFF. This does not affect the regulation, the device will continue normal regulation.

Management of technical room fan output and ON-OFF output

- If one of the available outputs is configured as "technical room fans" (value set to 11), the fans are always on (except for models with J/K thermocouples, where they are activated when the threshold set by parameter r37 is exceeded).
-
- If one of the available outputs is configured as "ON-OFF" (value set to 14), the relay will operate as follows:
 - OFF when the device is on stand-by mode
 - ON under all other conditions

Fryers

Inputs available

- Tank temperature probe
- Push encoder

Outputs available

- Heater
- Motor-driven basket 1
- Technical room fans
- ON-OFF
- Motor-driven basket 2

Information displayed

The display shows the cooking time of the two baskets (T1, T2) and, depending on how parameter "e4" is set, shows the temperature reading or the tank setpoint.

When the machine is switched on, only the time T1 of the first basket will be displayed by default, while timer T2 will only be displayed when selected.

Once the timer has elapsed, the display will still show 00:00 until the controller is switched off.

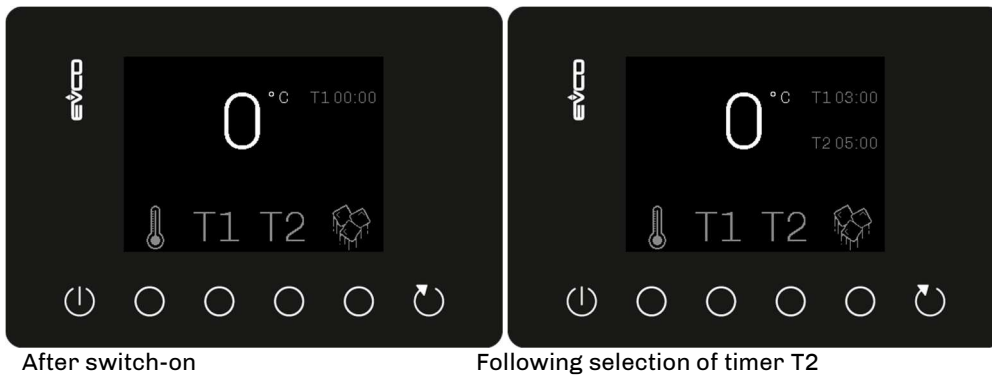

Available functions



Device ON/OFF

When the display is switched on, the following values are uploaded:

Temperature: 0

Time: T1: 00:00



Selection of tank temperature

Selection range [0 (r1) <-> 200°C (r2)]



Selection of active basket and cooking time



Selection range: [00:00<->59:59 mm:ss]

The timers automatically start when the time is set, but if ic1 and ic3 (multi-purpose input 1 and 2 function) are set to 4, the timers start upon receiving an impulse from the respective digital inputs (id1 for T1, id2 for T2). When one of the two parameters (ic1 or ic3) is set to 4, the other one automatically assumes the same value.

Consult the section "Management of motorised baskets" for operation with motorised baskets.



Activation MELT function

When this mode is activated, the MELT icon  replaces the temperature icon. This icon will flash; the keys to select the temperature and time will be deactivated. The value of the displayed temperature is set by parameter "e4".

This function can only be activated when the temperature of fryer is below 50°C

(parameter "r15"). To quit this mode, press the relative key again (or the push button on the encoder); the icon will stay on and the temperature/time will be displayed.

Information displayed if an output is set for oil filtering (value 16)

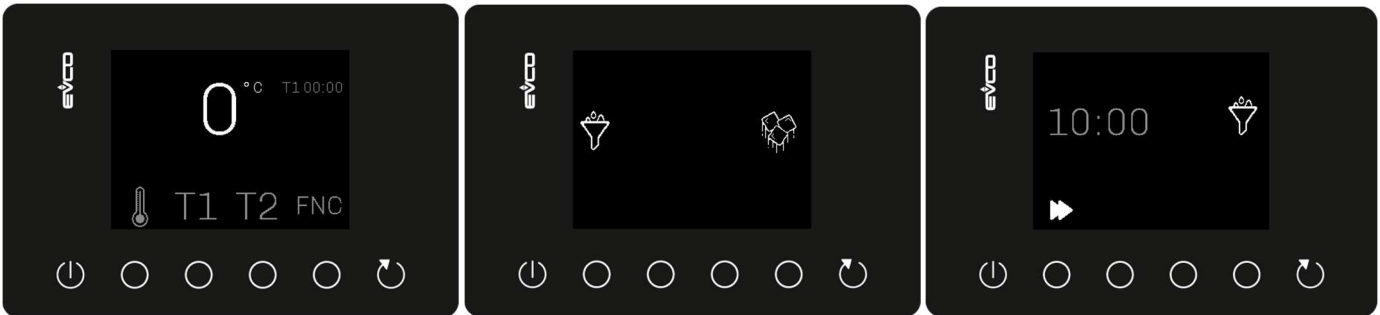

FNC Selection of either MELT or oil filtering function
 The FNC icon will be displayed instead of the icon if one of the outputs is configured with the value 16 (oil filtering). When FNC is selected, a menu opens allowing user to select either the MELT or oil filtering function. To exit this menu, even at the end of the selected cycle, press the key



Activation MELT function
 See above for operating details.



Activation OIL FILTERING function
 By entering this menu, the time set with parameter **e12** (duration of oil filtering cycle) is loaded. The count begins when the key is pressed and is interrupted by pressing the same key again. The time left to complete the cycle is given and it can be resumed at any time by pressing the key again. The output configured as "oil filtering" is activated depending on the status of the cycle.

ES Activation energy-saving function (only if e24 = 1)
 This function enables rapid setting of a holding setpoint for the oil temperature. To activate it, press the key. Now press the **ES** key, which will load the value of parameter e25. Repeat the activation procedure to deactivate this function.
N.B.: the tank setpoint prior to activation of the function will be saved and restored when the energy-saving function is deactivated.



Refresh
 This reloads the last time value set on the selected timer and, when in the menu to select between the MELT and OIL FILTERING functions, it takes the user back to the main menu.

Operation

- All the functions listed above can be selected using the function keys or the push encoder, as described in the general introduction.
 - During setting, the value to change will flash.
The hours/minutes or minutes/seconds on the timer are modified separately.
 - If confirmation is not given within 5 seconds, it will automatically validate the displayed value.
- Heating
 - Normal method
 - The unit begins heating when the value of the regulation probe is lower than the set value; heating will be interrupted when the value is higher. Heating is restored in the same way, when the value goes down again.
 - When the set temperature is reached, a warning icon  will appear on the screen. The icon will disappear only when the temperature setpoint is changed or the controller switched off.
 - MELT method

This programme consists of a sequence of temperatures which are set to melt the pieces of fat in the fryer. The MELT programme has two settings, according to the energy source used. Parameter "e13" is used to select the type of MELT:

 - 0 = electrical fryer;
 - 1 = gas fryer.

When the set temperature is reached, a warning icon will appear on the screen .

MELT for electrical fryers:

 - if the probe temperature $\leq 47^{\circ}\text{C}$ ("r11") = the heater is always active
 - if 47°C ("r11") < probe temperature < 60°C ("r12")
 - the heater is activated for 10" ("r13")
 - as soon as the temperature goes down 1°C ("r14"), the previous point is repeated
 - if the probe temperature $\geq 60^{\circ}\text{C}$ ("r12") = the heater is switched off and holding begins
 - regulation resumes as soon as the temperature is 2°C ("r16") lower than the setpointThe buzzer is activated and is interrupted only if silenced manually.

MELT for gas fryers:

 - if the probe temperature < 100°C ("e16"):
 - the burner is activated for 12" ("e15") and then deactivated for 28" ("e14-e15")
 - if the probe temperature $\geq 100^{\circ}\text{C}$ ("e16") = the burner is switched off and holding begins
 - regulation resumes as soon as the temperature is 2°C ("e17") lower than the setpoint.The buzzer is activated and is interrupted only if silenced manually.
- The device will interrupt heating when switched OFF.
- When countdown ends (time at 00:00), the buzzer will sound until the button on the push encoder (or one of the 6 function keys) is pressed or until the timeout interval set by the relative parameter (e2) elapses, with a cycle of 0.5 "ON/0.5" OFF. This does not affect the regulation, the device will continue normal regulation.

Management of technical room fan output and ON-OFF output

- If one of the available outputs is configured as "technical room fans" (value set to 11), the fans are always on (except for models with J/K thermocouples, where they are activated when the threshold set by parameter r37 is exceeded).
- If one of the available outputs is configured as "ON-OFF" (value set to 14), the relay will operate as follows:
 - OFF when the device is on stand-by mode
 - ON under all other conditions

Management of motor-driven baskets

- If motor-driven baskets are in use, T1 e T2 keys can have further functions:
 - Manual operation (e8=0)
 - From key:
 - if held for 3 seconds, the corresponding relay will change status for a time $t_{10} \neq 0$
 - if $t_{10} = 0$, the key shall be touched again to go back to the initial status (defined by e9)
 - From encoder:
 - turn the push-encoder until the desired timer function lights up; hold it for 3 seconds
 - Automatic operation (e8=1)
 - From key:
 - the corresponding relay will change status for the time selected with the cooking setting and go back to the initial status (defined by e9) once the countdown ends
 - From encoder:
 - turn the push-encoder until the desired timer function lights up; hold it for 3 seconds

Pasta cookers

Inputs available

- Push encoder
- Level sensor (digital input)

Outputs available

- Heater
- Solenoid valve rapid tank filling
- Solenoid valve slow tank filling
- ON-OFF
- Technical room fans

N.B.: solenoid valves can never be activated at the same time

Information displayed

The display shows the value of the power and the cooking time of selected basket. The application is able to manage up to 6 timers, from T1 to T6, which are independent of each other, one for each configured basket.

When the machine is switched on, only the time T1 of the first basket will be displayed by default, while the timers T2 to T6 will only be displayed when selected.

Once the timer has elapsed, the display will still show the value "0" until the controller is switched off.

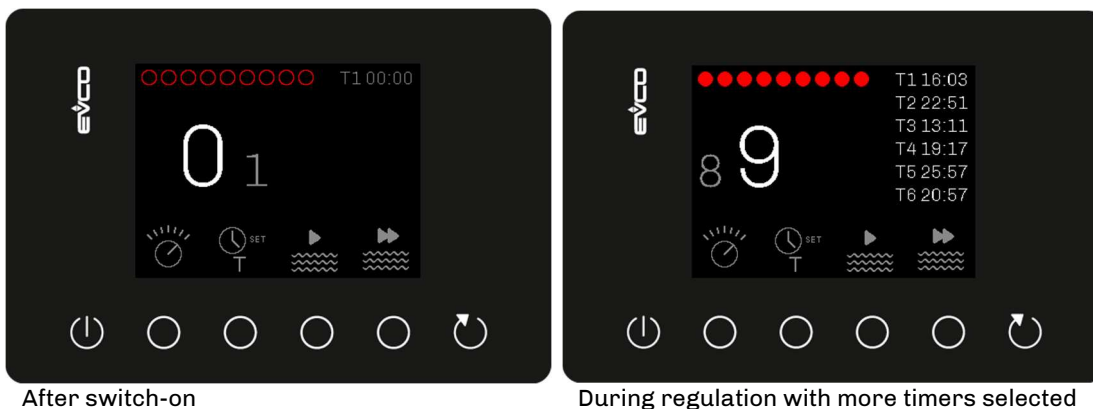

Available functions



Device ON/OFF

When the display is switched on, the following values are uploaded:

Power: 0

Timer time T1: 00:00



Power regulation:

Selection interval: [0<->9]



Selection of active basket

Choice of basket which the timer applies to: touch the key until the basket to be activated is selected and hold it down for 3 seconds

Selection interval: [0 <-> 6]



Selection of cooking time (referring to the selected basket T1-> T6)

Selection range: [00:00<->59:59 mm:ss]



Slow water filling:

activation/deactivation of the solenoid valve to slowly fill the tank.

This key works in a similar way to a switch, the solenoid valve is activated when it is pressed. When it is pressed again, the solenoid valve is deactivated ("toggle" switch).

To activate it, the key must be held down for 3 seconds, whereas deactivation is immediate.

When the function is active, the icon flashes.

When the function is deactivated, the icon stays on.



Rapid water filling:

activation/deactivation of the solenoid valve to rapidly fill the tank.

This key works in a similar way to a switch, the solenoid valve is activated when it is pressed. When it is pressed again, the solenoid valve is deactivated ("toggle" switch).

To activate it, the key must be held down for 3 seconds, whereas deactivation is immediate.

When the function is active, the icon flashes.

When the function is deactivated, the icon stays on.



Refresh

This reloads the last time value set on the selected timer.

Operation

- All the functions listed above can be selected using the function keys or the push encoder, as described in the general introduction.
 - During setting, the value to change will flash.
 - The hours/minutes or minutes/seconds on the timer are modified separately.
 - If confirmation is not given within 5 seconds, it will automatically validate the displayed value.
- The controller begins regulation when the value of the energy regulator is anything other than "0", based on the regulation value set by the relative parameters:
 - Regulator 1: 3" ON (r19)/45" OFF (r20)
 - Regulator 2: 4" ON (r21)/38" OFF (r22)
 - Regulator 3: 5" ON (r23)/32" OFF (r24)
 - Regulator 4: 7" ON (r25)/29" OFF (r26)
 - Regulator 5: 9" ON (r27)/30" OFF (r28)
 - Regulator 6: 13" ON (r29)/32" OFF (r30)
 - Regulator 7: 21" ON (r31)/37" OFF (r32)
 - Regulator 8: 45" ON (r33)/60" OFF (r34)
 - Regulator 9: always ON (r35/r36)
- Heating is interrupted when the power regulator is set with a value of "0" or when the controller is switched OFF.
- When countdown ends (time at 00:00), the buzzer will sound until the button on the push encoder (or one of the 6 function keys) is pressed or until the timeout interval set by the relative parameter (e2) elapses, with a cycle of 0.5 "ON/0.5" OFF. This does not affect the regulation, the device will continue normal regulation.

Management of technical room fan output and ON-OFF output

- If one of the available outputs is configured as "technical room fans" (value set to 11), the fans are always on (except for models with J/K thermocouples, where they are activated when the threshold set by parameter r37 is exceeded).
-
- If one of the available outputs is configured as "ON-OFF" (value set to 14), the relay will operate as follows:
 - OFF when the device is on stand-by mode
 - ON under all other conditions

Water filling management

- Water can be filled in three different ways:
 - Manual filling (parameters ic1 and ic3≠2, e18 and e21=0)

Water can only be loaded using the key if no digital input is configured as "level sensor" (ic1 and ic3 ≠2). Loading is not timed, so both load times are e18 and e21=0.
 - Timed filling (parameters e18 or e21≠0)

Initial activation is always carried out using the key and the valve will automatically be deactivated when the time set by parameter e18 or e21 has elapsed.

N.B.: water can be loaded in this way once only every time the controller goes from OFF to ON. All other times, the load key will only activate the solenoid valve if held down.

Once the first load has been carried out, the solenoid valve will wait for the time set by parameter e19 or e22 before reloading the water with time e20 or e23. This cycle will be repeated indefinitely until the controller goes OFF.

N.B.: as the paster cooker has two different ways of loading water, the rapid load will use parameters e18, e19 and e20 (these are shared with the bain-marie function). The slow load, on the other hand, will use parameters e21, e22 and e23.
 - Filling with level sensor (parameters ic1 or ic3=2, e18 and e21=0)

Initial activation is always carried out using the key (irrespective of whether filling is rapid or slow) and the valve will automatically be deactivated once the maximum level has been reached. Once the maximum level has been reached, if the water level goes below the minimum level set by the sensor, the slow load valve will automatically be activated/deactivated.

After the first load, the load key will force the valve to be activated if held down (the valve closes when released). To load the water once again, the device must be switched off and then back on again at least once.

N.B.: filling with the level sensor has priority over all the others. Make sure parameters ic1 and ic3≠2 are set correctly to enable manual or timed filling.

Bain-marie

Inputs available

- Regulation probe (only when temperature controlled with e26=1)
- Push encoder
- Level sensor (digital input)

Outputs available

- Heater
- Solenoid valve to load water
- Solenoid valve to discharge water
- ON-OFF
- Technical room fans

Solenoid valves can never be activated at the same time

Information displayed

The display shows the cooking time and the temperature of the tank. The temperature can refer to the reading or the setpoint, depending on how parameter "e4" is set.

Configuration parameter e26 = 1 (temperature controlled)

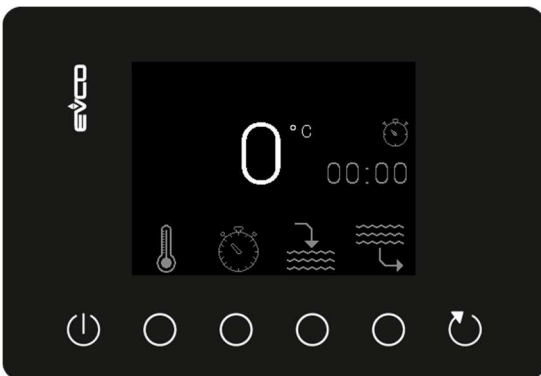

Temperature switch-on screen

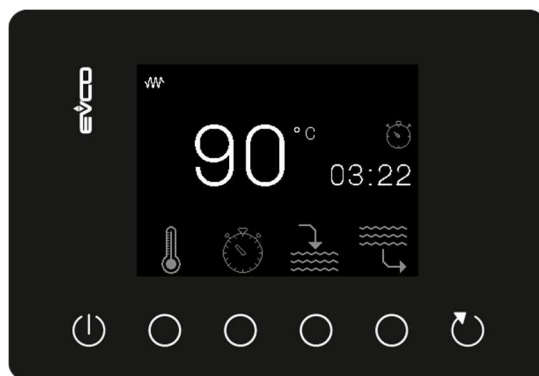

Temperature regulation screen

Configuration parameter e26 = 0 (power controlled)

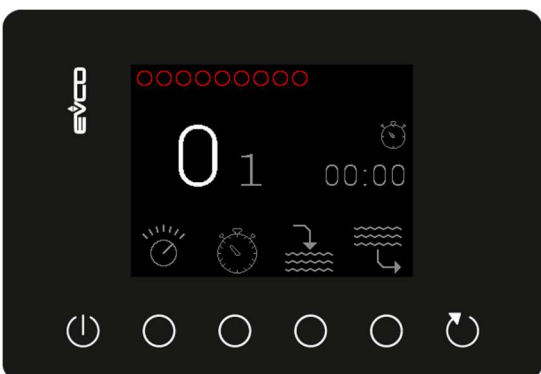

Power switch-on screen

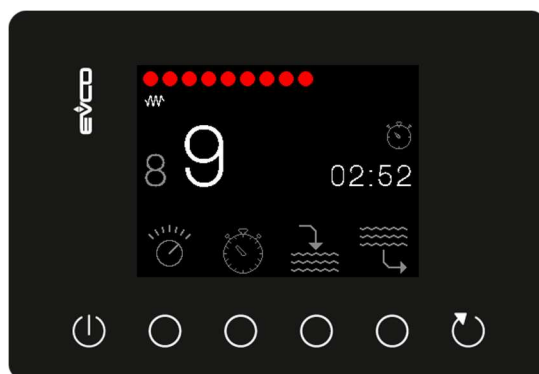

Power regulation screen

Available functions



Device ON/OFF

When the display is switched on, the following values are uploaded:

Temperature: 0

Timer time 00:00 hh:mm



Selection of tank temperature

Selection range [0 (r1) <-> 90°C (r2)]



Selection of cooking time

Selection range [00:00 <-> 59:59 mm:ss]



Water filling

activation/deactivation of the solenoid valve to fill the tank.

This key works in a similar way to a switch, the solenoid valve is activated when it is pressed. When it is pressed again, the solenoid valve is deactivated ("*toggle*" switch).

To activate it, the key must be held down for 3 seconds, whereas deactivation is immediate.

If the level sensor is fitted, the water stops loading as soon as the maximum level is detected by the sensor.

If the solenoid valve is active, the icon flashes

If the solenoid valve is deactivated, the icon stays on



Water discharge

activation/deactivation of the solenoid valve to discharge the tank.

This key works in a similar way to a switch, the solenoid valve is activated when it is pressed. When it is pressed again, the solenoid valve is deactivated ("*toggle*" switch).

To activate it, the key must be held down for 3 seconds, whereas deactivation is immediate.

If the level sensor is fitted, the water stops loading as soon as the maximum level is detected by the sensor.

If the solenoid valve is active, the discharge icon flashes

If the solenoid valve is deactivated, the discharge icon stays on



Refresh

This reloads the last time value set on the selected timer.

Operation

- All the functions listed above can be selected using the function keys or the push encoder, as described in the general introduction.
 - During setting, the value to change will flash.
 - The hours/minutes or minutes/seconds on the timer are modified separately.
 - If confirmation is not given within 5 seconds, it will automatically validate the displayed value.
- The unit begins heating when the value of the regulation probe is lower than the set value; heating will be interrupted when the value is higher. Heating is restored in the same way, when the value goes down again. Regulation continues until the regulator is not switched OFF.
- When the set temperature is reached, a warning icon  will appear on the screen. The icon will disappear only when the temperature setpoint is changed or the controller switched off.
- The device will interrupt heating:
 - when it is switched OFF
 - during every water load and discharge (either activated by the key or if the sensor is fitted)
- When countdown ends (time at 00:00), the buzzer will sound until the button on the push encoder (or one of the 6 function keys) is pressed or until the timeout interval set by the relative parameter (e2) elapses, with a cycle of 0.5 "ON/0.5" OFF. This does not affect the regulation, the device will continue normal regulation.

Management of technical room fan output and ON-OFF output

- If one of the available outputs is configured as "technical room fans" (value set to 11), the fans are always on (except for models with J/K thermocouples, where they are activated when the threshold set by parameter r37 is exceeded).
-
- If one of the available outputs is configured as "ON-OFF" (value set to 14), the relay will operate as follows:
 - OFF when the device is on stand-by mode
 - ON under all other conditions
-

Water filling management with bain-marie

- Water can be filled in three different ways:
 - Manual filling (parameters ic1 and ic3≠2, e18=0) Water can only be loaded using the key if no digital input is configured as "level sensor" (ic1 and ic3 ≠2). Loading is not timed, so load time is e18=0.
 - Timed filling (parameters ic1 and ic3≠2, e18≠0)
Initial activation is always carried out using the key and the valve will automatically be deactivated when the time set by parameter e18 has elapsed.
N.B.: water can be loaded in this way once only every time the controller goes from OFF to ON. All other times, the load key will only activate the solenoid valve if held down.
Once the first load has been carried out, the solenoid valve will wait for the time set by parameter e19 before reloading the water with time e20. This cycle will be repeated indefinitely until the controller goes OFF.
 - Filling with level sensor (parameters ic1 or ic3=2, e18=0)
Initial activation is always carried out using the key (holding it down) and the valve will automatically be deactivated once the maximum level has been reached. Once the maximum level has been reached, if the water level goes below the minimum level set by the sensor, the load valve will automatically be activated/deactivated. After the first load, the load key will force the valve to be activated if held down (the valve closes when released). To load the water once again, the device must be switched off and then back on again at least once.

N.B.: filling with the level sensor has priority over all the others. Make sure parameters ic1 and ic3≠2 are set correctly to enable manual or timed filling.

Quick change of bain-marie timer time base

- By pressing the  key, the timer time base can be changed quickly without having to alter parameter r18.

Connectivity

Users can interact remotely with their equipment using the EPoCA cloud platform with Wi-Fi or Ethernet connectivity (which also enables alternative or parallel control through MODBUS TCP). Onsite, they can interact from a mobile device with the EVconnect app which uses Bluetooth Low Energy connectivity. For more details, compare the connectivity options in the "Main features and purchasing codes" table and consult the Management and Monitoring Products/Systems and the Connectivity Products/Devices sections of our website www.evco.it.

EPoCA cloud platform

EPoCA® is a remote management and monitoring system based on a cloud platform. Originally developed to meet the management needs of the food preservation and cooking sector, it has been expanded to HVAC units in response to market demand.

To connect to the cloud system and remotely control machinery from a PC, tablet or smartphone, all users need is an EVCO controller with native EPoCA® technology and connectivity which is either built-in or provided by external hardware modules. All devices are configured using the dedicated EPoCA Start mobile app.

The responsive design and the graphic interface conceived to provide a pleasant user experience make EPoCA® a "ready-to-use" solution for easily accessible management and monitoring operations, even for entry-level users, while offering all the typical functions of professional platforms.

With the appropriate protection measures for access and data, the system makes it possible for one or more enabled users to operate remotely on the unit to configure its parameters, activate cycles, receive automatic alerts, view data (also as a graph) and download records in the most popular formats, such as XLSX, CSV and PDF

EVconnect mobile app

EVconnect is an app for Android and iOS that makes it possible to use Bluetooth BLE (Bluetooth Low Energy) to operate EVCO controllers with built-in BLE or models that can be expanded with the EVlink BLE module.

The EVlink interface (EVIF25TBX) is easy to install and has a compact footprint. It acts as a data logger, automatically storing historical data, needs no programming and is powered by the controller.

Logged data can be downloaded and viewed (even in graph or table form) from your smartphone or tablet, and alarms and machine status can be checked. The information can be exported in CSV format then, for example, attached to an email.

Besides facilitating data monitoring and technical support, EVconnect lets you keep your equipment settings to hand. Fully protected by multiple-level access codes, your device becomes a handy tool for adjusting your equipment's setpoints and configuration. A list of parameters, together with a full description of each one, makes configuration even simpler.

List of alarms

When an alarm is detected, the buzzer will be activated and the label with the type of active alarm will be shown on the display. Press any function key or the push encoder to silence the buzzer and go back to the regulation screen. The alarm icon is shown until the alarm is reset.

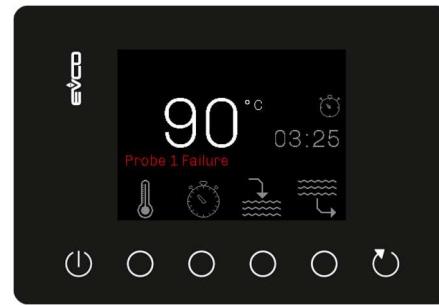

Alarm

Table of alarms

The following table lists the types of alarms which can be set off, with the action to take to correct them and their consequences

Type of alarm	To correct	Consequences
Regulation probe alarm	<ul style="list-style-type: none"> – check the type of regulation probe – check the device-cabinet probe connection 	<ul style="list-style-type: none"> – the temperature regulation output will be switched off – the alarm output will be activated
Needle probe alarm	<ul style="list-style-type: none"> – check the type of needle probe – check the device-needle probe connection 	<ul style="list-style-type: none"> – if the alarm is raised when the device is on, timed cooking can be started up – if the alarm is raised during cooking, the alarm output will be activated
Power failure alarm	<ul style="list-style-type: none"> – check the device-network connection 	<ul style="list-style-type: none"> – when power is restored, regulation must be reactivated manually – the alarm output will be activated
Door open alarm	<ul style="list-style-type: none"> – close the door 	<ul style="list-style-type: none"> – the alarm output will be activated
Board temperature alarm (only models with J/K thermocouples)	<ul style="list-style-type: none"> – check the operating temperature of the control module; parameter "A5" 	<ul style="list-style-type: none"> – if the alarm is raised during regulation, it will be suspended and all outputs deactivated
Power consumption alarm (if the digital input is configured)	<ul style="list-style-type: none"> – check the total consumption of all the machines installed 	<ul style="list-style-type: none"> – if the alarm is raised during regulation, it will be suspended and all outputs deactivated
Max temperature alarm (referring to the regulation probe)	<ul style="list-style-type: none"> – check parameters "A7", "A8", "A9", "A10" 	<ul style="list-style-type: none"> – the alarm output will be activated – the heating output will be deactivated until the alarm is reset

Parameters

Managing parameters

The firmware has 9 default maps, each of which corresponds to a precise configuration. The parameters of the active configuration can be changed using the keypad or the EVJKEY key only if the controller is in the OFF position.

The password must be entered to access the following menus.

- **Configuration:** PW "19"
only the "type of application" machine configuration parameter will be visible and can be changed
The default parameters of the selected configuration will always be loaded using this operation and the present parameters will be overwritten
- **Service:** PW "-19"
All the parameters, except the machine configuration parameter, will be visible and can be changed
PW "-20"
all the parameters will be visible but cannot be changed
- **Restore parameters:** PW "149"
the default parameters of the active application will be restored

N.B.: when the operation is complete, the controller will automatically return to the OFF position

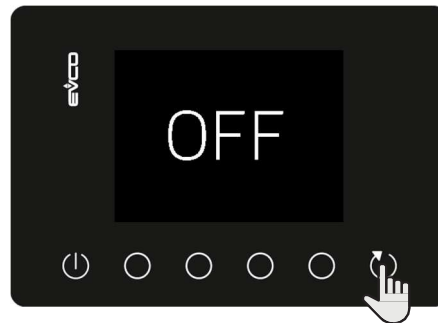

Changes using the keypad
If the REFRESH key is held down for 3 seconds on the "OFF screen", access will be granted to the "configuration screen"

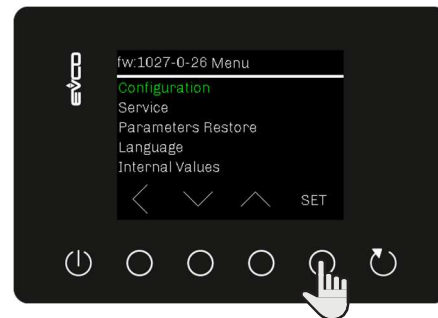

Configuration screen
Press the "UP" and "DOWN" keys to select the menu, then the "SET" key to confirm

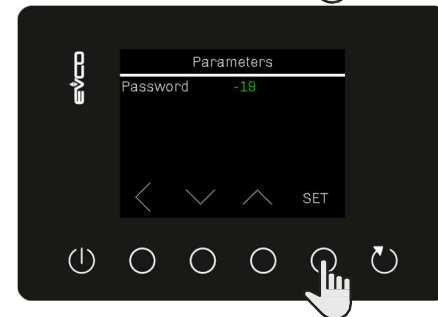

Password
Press the "UP" and "DOWN" keys to set the password, then the "SET" key to confirm and access the menu

Making changes using the EVJKEY

All the map of the parameters, including machine configuration, can be uploaded and downloaded using the EVJKEY key.

When downloading from the key to the controller, the parameters saved in the controller are the ones on the key and not the default parameters.

Table of parameters

Code	Description	Min	Max	Unit	Electric hot plates	Bain-marie	Tilting pans	Boiling pans	Fry-tops	Cast iron grills	Fryers	Pasta cookers	Ovens
Analogue inputs													
P0	Type of probe (not visible with EVJ705Z9): 0 = Pt 100 1 = J 2 = K	0	2	---	NA	0	0	NA	0	NA	0	NA	0
P2	Temperature measurement unit 0 = °C 1 = °F	0	1	---	NA	0	0	NA	0	NA	0	NA	0
Pr2	Needle probe 0 = none 1 = present	0	1	°C\°F	ND	ND	1	ND	1	ND	ND	ND	1
CA1	Regulation probe offset	-25	25	°C\°F	NA	0	0	NA	0	NA	0	NA	0
CA2	Needle probe offset	-25	25	°C\°F	NA	NA	0	NA	0	NA	NA	NA	0
CA3	Unused	---	---	---	---	---	---	---	---	---	---	---	---
Main regulation													
r0	Cabinet setpoint differential	1	25	°C\°F	NA	2	2	NA	2	NA	2	NA	2
r1	Minimum cabinet setpoint	0	r2	°C\°F	NA	0	0	NA	0	NA	0	NA	0
r2	Maximum cabinet setpoint	r1	450	°C\°F	NA	90	300	NA	300	NA	200	NA	300
r3	Cabinet setpoint	-99.9	99.9	°C\°F	NA	0	0	NA	0	NA	0	NA	0
r4	Minimum needle setpoint	0	r5	°C\°F	NA	NA	0	NA	0	NA	NA	NA	0
r5	Maximum needle setpoint	r4	450	°C\°F	NA	NA	99	NA	99	NA	NA	NA	99
r6	Needle setpoint	r4	r5	°C\°F	NA	NA	0	NA	0	NA	NA	NA	0
r11	Melt heaters ON threshold	0	100	°C\°F	NA	NA	NA	NA	NA	NA	47	NA	NA
r12	Melt heaters OFF threshold	0	100	°C\°F	NA	NA	NA	NA	NA	NA	60	NA	NA
r13	Heater time on if temperature is between r11 and r12	0	999	Sec	NA	NA	NA	NA	NA	NA	10	NA	NA
r14	Differential to reactivate heater for time r13	1	25	°C\°F	NA	NA	NA	NA	NA	NA	1	NA	NA
r15	Minimum temperature for MELT cycle	0	999	°C\°F	NA	NA	NA	NA	NA	NA	50	NA	NA
r16	Holding differential for MELT cycle	1	25	°C\°F	NA	NA	NA	NA	NA	NA	2	NA	NA
r17	Maximum settable time first number timer (the second one is always settable between 0 and 59)	0	99	See "r18"	59	59	23	23	59	59	59	59	23
r18	Timer time base: 0 = hh:mm 1 = mm:ss	0	1	---	1	1	0	0	1	1	1	1	0
r19	Time power regulator 1 is on	1	240	Sec	2	3	3	3	NA	3	NA	3	NA

Code	Description	Min	Max	Unit										
					Electric hot plates	Bain-marie	Tilting pans	Boiling pans	Fry-tops	Cast iron grills	Fryers	Pasta cookers	Ovens	
r20	Time power regulator 1 is off (if r20 = 0 and r19 ≠ 0, power regulator 1 is always on)	0	240	Sec	10	45	45	45	NA	45	NA	45	NA	
r21	Time power regulator 2 is on	1	240	Sec	4	4	4	4	NA	4	NA	4	NA	
r22	Time power regulator 2 is off (if r22 = 0 and r21 ≠ 0, power regulator 2 is always on)	0	240	Sec	10	38	38	38	NA	38	NA	38	NA	
r23	Time power regulator 3 is on	1	240	Sec	6	5	5	5	NA	5	NA	5	NA	
r24	Time power regulator 3 is off (if r24 = 0 and r23 ≠ 0, power regulator 3 is always on)	0	240	Sec	10	32	32	32	NA	32	NA	32	NA	
r25	Time power regulator 4 is on	1	240	Sec	8	7	7	7	NA	7	NA	7	NA	
r26	Time power regulator 4 is off (if r26 = 0 and r25 ≠ 0, power regulator 4 is always on)	0	240	Sec	10	29	29	29	NA	29	NA	29	NA	
r27	Time power regulator 5 is on	1	240	Sec	10	9	9	9	NA	9	NA	9	NA	
r28	Time power regulator 5 is off (if r28 = 0 and r27 ≠ 0, power regulator 5 is always on)	0	240	Sec	10	30	30	30	NA	30	NA	30	NA	
r29	Time power regulator 6 is on	1	240	Sec	12	13	13	13	NA	13	NA	13	NA	
r30	Time power regulator 6 is off (if r30 = 0 and r29 ≠ 0, power regulator 6 is always on)	0	240	Sec	10	32	32	32	NA	32	NA	32	NA	
r31	Time power regulator 7 is on	1	240	Sec	NA	21	21	21	NA	21	NA	21	NA	
r32	Time power regulator 7 is off (if r32 = 0 and r31 ≠ 0, power regulator 7 is always on)	0	240	Sec	NA	37	37	37	NA	37	NA	37	NA	
r33	Time power regulator 8 is on	1	240	Sec	NA	45	45	45	NA	45	NA	45	NA	
r34	Time power regulator 8 is off (if r34 = 0 and r33 ≠ 0, power regulator 8 is always on)	0	240	Sec	NA	60	60	60	NA	60	NA	60	NA	
r35	Time power regulator 9 is on	1	240	Sec	NA	1	1	1	NA	1	NA	1	NA	
r36	Time power regulator 9 is off (if r36 = 0 and r35 ≠ 0, power regulator 9 is always on)	0	240	Sec	NA	0	0	0	NA	0	NA	0	NA	
r37	Technical room fan setpoint (only for models with J/K thermocouples)	0	99	°C\°F	50	50	50	50	50	50	50	50	50	
r38	Proportional band 0 = on-off control	0	99	°C\°F	NA	0	0	NA	0	NA	0	NA	0	
r39	Integral action time 0 = only proportional action	0	240	Sec	NA	0	0	NA	0	NA	0	NA	0	
r40	Delay between 2 heater switch-ons	60	999	Sec	NA	180	180	NA	180	NA	180	NA	180	
r41	Minimum time heater on/off	10	240	Sec	NA	10	10	NA	10	NA	10	NA	10	
r42	ΔT setpoint	r43	r44	°C\°F	NA	NA	NA	NA	NA	NA	NA	NA	5	
r43	Minimum ΔT setpoint	0	r44	°C\°F	NA	NA	NA	NA	NA	NA	NA	NA	0	
r44	Maximum ΔT setpoint	r43	150	°C\°F	NA	NA	NA	NA	NA	NA	NA	NA	30	
Digital inputs														
i2	Door open alarm delay -1 = Disabled	-1	120	Min	NA	NA	-1	NA	NA	NA	NA	NA	NA	

Code	Description	Min	Max	Unit									
					Electric hot plates	Bain-marie	Tilting pans	Boiling pans	Fry-tops	Cast iron grills	Fryers	Pasta cookers	Ovens
ic1	Multi-purpose input 1 function 0 = Disabled 1 = Door switch 2 = Level sensor 3 = Maximum power 4 = Start/Stop T1-T2	0	4	---	0	0	1	0	0	0	0	0	0
ip1	Multi-purpose input 1 activation 0 = With contact closed 1 = With contact open	0	1	---	0	0	0	0	0	0	0	0	0
ic3	Multi-purpose input 2 function 0 = Disabled 1 = Generic alarm 2 = Level sensor 3 = Maximum power 4 = Start/Stop T1-T2	0	4	---	0	0	0	0	0	0	0	0	0
ip3	Multi-purpose input 2 activation 0 = With contact closed 1 = With contact open	0	1	---	0	0	0	0	0	0	0	0	0
i7	Delay in water loading stop	0	120	s	NA	4	NA	NA	NA	NA	NA	4	NA
Alarms													
A0	Display regulation probe alarm 0 = No 1 = Yes	0	1	---	NA	1	1	NA	1	NA	1	NA	1
A2	Display needle probe alarm 0 = No 1 = Yes	0	1	---	NA	NA	1	NA	1	NA	NA	NA	1
A5	Alarm output logic 0 = with alarm active 1 = with alarm not active	0	1	---	0	0	0	0	0	0	0	0	0
A6	Board temperature alarm threshold (only for models with J/K thermocouples)	0	80	°C\°F	70	70	70	70	70	70	70	70	70
A7	High temperature alarm threshold (see A8-A9-A10)	0	450	°C\°F	ND	20	20	ND	20	ND	20	ND	20
A8	High temperature alarm reset differential	1	99	°C\°F	NA	5	5	NA	5	NA	5	NA	5
A9	High temperature alarm delay	0	250	min	NA	2	2	NA	2	NA	2	NA	2
A10	High temperature alarm type 0 = Disabled 1 = Absolute 2 = Relative to setpoint	0	2	---	NA	0	0	NA	0	NA	0	NA	0
A12	Display power failure alarm 0 = No 1 = Yes	0	1	---	0	0	0	0	0	0	0	0	0
A13	Device status after power failure alarm 0 = OFF 1 = Previous status				0	0	0	0	0	0	0	0	0

Code	Description	Min	Max	Unit	Electric hot plates	Bain-marie	Tilting pans	Boiling pans	Fry-tops	Cast iron grills	Fryers	Pasta cookers	Ovens
Digital outputs													
uc1	K1 relay configuration 0 = Not used 1 = Heater 2 = Bottom heater 3 = Top heater 4 = Water solenoid valve 5 = Hot water solenoid valve 6 = Cold water solenoid valve 7 = Slow load solenoid valve 8 = Rapid load solenoid valve 9 = Alarm 10 = Discharge solenoid valve 11 = Technical room fans (not in use in the EVJ705Z9 model) 12 = Motor basket 1 13 = Motor basket 2 14 = ON-OFF 15 = AUX 16 = Oil filtering	0	16	---	1	1	1	1	1	1	1	1	2
uc2	K2 relay configuration: as "uc1"	0	16	---	0	4	4	5	15	0	12	7	3
uc4	K4 relay configuration: as "uc1"	0	16	---	11	10	11	6	11	11	11	8	11
uc5	K5 relay configuration: as "uc1"	0	16	---	14	14	14	14	14	14	14	14	14
uc6	K6 relay configuration: as "uc1"	0	16	---	0	11	0	11	0	0	13	11	0
Other parameters													
PSr	Enable silencing alarm output 0 = No 1 = Yes	0	1	---	1	1	1	1	1	1	1	1	1
Pbu	Buzzer configuration 0 = Disabled 1 = Only alarms 2 = Alarms + keypad	0	2	---	2	2	2	2	2	2	2	2	2
SEn	Capacitive keypad threshold	50	100	---	70	70	70	70	70	70	70	70	70
Hr0	Enable clock 0 = No 1 = Yes	0	1	---	0	0	0	0	0	0	0	0	0
bLE	Serial port configuration for connectivity 0 = free for MODBUS RTU 1÷99 = EPoCA local network address (in this case the baud rate is automatically configured to 19,200 baud irrespective of the Lb value) N.B.: if connectivity comes from EVlinking Wi-Fi, the only value that can be set is 1	0	99	---	0	0	0	0	0	0	0	0	0
rE0	Data logger sampling interval	0	240	min	5	5	5	5	5	5	5	5	5
rE1	Select probes for data logger recordings 0 = None 1 = Chamber probe 2 = Needle probe 3 = Not used 4 = Cabinet probe and needle probe 5 = All probes	0	5	---	4	4	4	4	4	4	4	4	4







Code	Description	Min	Max	Unit	Electric hot plates	Bain-marie	Tilting pans	Boiling pans	Fry-tops	Cast iron grills	Fryers	Pasta cookers	Ovens
					1	2	3	4	5	6	7	8	9
Configurations													
e1	Type of application 0 = None 1 = Electric hot plates 2 = Bain-marie 3 = Tilting pans 4 = Boiling pans 5 = Fry-tops 6 = Cast iron grills 7 = Fryers 8 = Pasta cookers 9 = Ovens	0	9	---	1	2	3	4	5	6	7	8	9
e2	Time of buzzer activation from end of timer and from reached setpoint -1 = Until silencing 0 = Disabled	-1	120	Sec	30	30	30	30	30	30	30	30	30
e3	Value displayed in stand-by 0 = Label "OFF" 1 = Key on/off icon	0	1	---	0	0	0	0	0	0	0	0	0
e4	Value displayed when on 0 = Reading regulation and needle probes 1 = Setpoint regulation and needle probes	0	1	---	NA	0	0	NA	0	NA	0	NA	0
e5	Timer displayed at end of count 0 = 00:00 1 = Last set value	0	1		1	1	1	1	1	1	1	1	1
e6	Zoom page timers active 0 = No 1 = Yes	0	1		1	1	1	1	1	1	1	1	1
e7	Enable MELT cycle at power-on 0 = No 1 = Yes	0	1		NA	NA	NA	NA	NA	NA	0	NA	NA
e8	Basket operation mode 0 = manual 1 = automatic	0	1	---	ND	ND	ND	ND	ND	ND	1	ND	ND
e9	Relay status from "Stand-by" to "ON" 0 = deactivated 1 = activated In stand-by mode the relays are always deactivated	0	1	---	ND	ND	ND	ND	ND	ND	0	ND	ND
e10	Basket relay status change If e10 = 0, the relay status will be changed touching again for 3 seconds the corresponding timer key (T1 o T2)	0	240	X10 sec	ND	ND	ND	ND	ND	ND	6	ND	ND
e11	Temperature regulation Setpoint/Power 0 = default 1 = last memorized value	0	1	---	0	0	0	0	0	0	0	0	0
e12	Oil filtering cycle duration	0	240	min	ND	ND	ND	ND	ND	ND	10	ND	ND
e13	Type of MELT cycle 0 = electrical fryer 1 = gas fryer	0	1	---	ND	ND	ND	ND	ND	ND	0	ND	ND
e14	Time MELT gas cycle	0	999	sec	ND	ND	ND	ND	ND	ND	40	ND	ND
e15	Time On MELT gas cycle	0	999	sec	ND	ND	ND	ND	ND	ND	12	ND	ND
e16	MELT OFF threshold gas cycle	0	100	°C/°F	ND	ND	ND	ND	ND	ND	100	ND	ND
e17	Holding differential MELT gas cycle	0	25	°C/°F	ND	ND	ND	ND	ND	ND	2	ND	ND
e18	Starting water load time (for bain-marie) Starting water rapid load time (for pasta cooker)	0	240	X10 sec	ND	0	ND	ND	ND	ND	ND	0	ND

Code	Description	Min	Max	Unit									
					Electric hot plates	Bain-marie	Tilting pans	Boiling pans	Fry-tops	Cast iron grills	Fryers	Pasta cookers	Ovens
e19	Pause time between loads (for bain-marie) Pause time between rapid loads (for pasta cooker)	1	240	X10 min	ND	1	ND	ND	ND	ND	ND	1	ND
e20	Reload time (for bain-marie) Rapid reload time (for pasta cooker)	0	480	sec	ND	5	ND	ND	ND	ND	ND	5	ND
e21	Starting water slow load time for pasta cooker	0	240	X10 sec	ND	ND	ND	ND	ND	ND	ND	0	ND
e22	Pause time between slow loads for pasta cooker	1	240	X10 min	ND	ND	ND	ND	ND	ND	ND	1	ND
e23	Slow reload time for pasta cooker	0	480	sec	ND	ND	ND	ND	ND	ND	ND	5	ND
e24	Enable energy-saving function for fryer	0	1	---	ND	ND	ND	ND	ND	ND	0	ND	ND
e25	Holding temperature setpoint in energy-saving function	0	999	°C/°F	ND	ND	ND	ND	ND	ND	60	ND	ND
e26	Bain-marie cooking mode 0 = Power 1 = Temperature	0	1	---	ND	1	ND	ND	ND	ND	ND	ND	ND
Security													
PAS	Password	-990	999	---	-19	-19	-19	-19	-19	-19	-19	-19	-19
LA	MODBUS address	1	247	---	247	247	247	247	247	247	247	247	247
Lb	MODBUS baud rate 0 = 2400 1 = 4800 2 = 9600 3 = 19200	0	3	---	3	3	3	3	3	3	3	3	3
Lp	MODBUS parity 0 = none 1 = odd 2 = even	0	2	---	2	2	2	2	2	2	2	2	2

N.B.: the parameters configured as NA (not available) are not necessary for that type of application so will not be displayed

Accessories

List of accessories

Images	Code	Description
	EVJKEY	<p>Programming key Allows configuration upload and download.</p>
	EVIF24TSX	<p>Module for TTL/RS-485 signal conversion Allows connection to an RS-485 network</p>
	EVIF23TSX	<p>Module for TTL/RS-485 signal conversion + clock Activates real-time functions and connection to an RS-485 network.</p>
	EVIF25TBX	<p>EVlinking BLE module Through the TTL communications port, the module provides the controller with Bluetooth Low Energy connectivity which enables wireless management from smartphones and tablets using the EVconnect app.</p>
	EVIF25SWX	<p>EVlinking Wi-Fi TTL module Through the TTL communications port, the module provides the controller with Wi-Fi connectivity which enables remote management and monitoring from the Internet using the EPoCA® cloud system.</p>
	EV3W01	<p>IoT EV3 Web gateway IoT gateway with Ethernet connectivity and data logging functions to remotely monitor and control an RS-485 MODBUS RTU network with up to 10 EVCO controllers with EPoCA® technology using the EPoCA® cloud platform.</p>
	EVC99C00X 0XXX01	<p>Push encoder Enables use of the controller even when there are no keys.</p>

Technical specifications

Purpose of the control device:	function controller.	
Construction of the control device:	built-in electronic device.	
Housing:	black, self-extinguishing.	
Category of heat and fire resistance:	D.	
Measurements:	111.4 x 76.4 x 48.5 mm (4 3/8 x 3 x 1 15/16 in).	
Mounting methods for the control device:	depending on the model, front installation on a plastic or metal panel (with elastic holding flaps) or concealed under glass or methacrylate panels (with double-sided adhesive tape) personalising the keys on the front of the unit.	
Degree of protection provided by the casing:	IP65 (front), provided that the device is installed on a metal panel 0.8 mm (1/32 in) thick.	
Connection method:		
fixed screw terminal blocks for wires up to 2.5 mm ² (plug-in screw terminal blocks for wires up to 2.5 mm ² on request)	Pico-Blade connector.	
Maximum permitted length for connection cables:		
power supply: 10 m (32.8 ft)	analogue inputs: 10 m (32.8 ft)	
digital inputs: 10 m (32.8 ft)	digital outputs: 10 m (32.8 ft).	
Operating temperature:	from -5 to 55 °C (from 23 to 131 °F).	
Storage temperature:	from -25 to 70 °C (from -13 to 158 °F).	
Operating humidity:	relative humidity without condensate from 10 to 90%.	
Pollution status of the control device:	2.	
Compliance:		
RoHS 2011/65/EC	WEEE 2012/19/EU	REACH (EC) Regulation no. 1907/2006
EMC 2014/30/EU	LVD 2014/35/EU.	
Power supply:	115... 230 VAC (+10 % -15 %), 50/60 Hz (±3 Hz), max. 6 VA.	
Earthing methods for the control device:	none.	
Rated impulse-withstand voltage:	2.5 KV.	
Over-voltage category:	II.	
Software class and structure:	A.	
Analogue inputs:	2 depending on the model for Pt 1000 2-wire probes or for J/K/probes Pt 100 2 wires thermocouples (regulation probe and needle probe).	
Digital inputs:	2 dry contact (multi-purpose).	
Dry contact	Type of contact:	5 VDC, 1.5 mA
	Power supply:	none
	Protection:	none.

Digital outputs:	EVJ705Z9	EVJ705J9 and EVJ705J9VG	EVJ725J9
K1 relay:	electro-mechanical relay SPST, 16 A res. @ 250 VAC	electro-mechanical relay SPST, 16 A res. @ 250 VAC	electro-mechanical relay SPST, 16 A res. @ 250 VAC
K2 relay:	electro-mechanical relay SPST, 8 A res. @ 250 VAC	electro-mechanical relay SPST, 5 A res. @ 250 VAC	command for solid state relays, 12 VDC, 15 mA max
K4 relay:	electro-mechanical relay SPST, 8 A res. @ 250 VAC	electro-mechanical relay SPST, 8 A res. @ 250 VAC	electro-mechanical relay SPST, 8 A res. @ 250 VAC
K5 relay:	electro-mechanical relay SPST, 5 A res. @ 250 VAC	electro-mechanical relay SPST, 8 A res. @ 250 VAC	electro-mechanical relay SPST, 8 A res. @ 250 VAC
K6 relay:	electro-mechanical relay SPST, 5 A res. @ 250 VAC.	electro-mechanical relay SPST, 5 A res. @ 250 VAC.	command for solid state relays, 12 VDC, 15 mA max
Type 1 or Type 2 actions:	type 1.		
Additional features of Type 1 or Type 2 actions:	C.		
Displays:	2.8 inch colour graphic display.		
Alarm buzzer:	built-in.		
Communications ports:	1 TTL MODBUS slave port for programming key or BMS.		



EVCO S.p.A.

Via Feltre 81, 32036 Sedico (BL) ITALY

| Tel. +39 0437 8422

| Fax +39 0437 83648

| e-mail info@evco.it

| web www.evco.it

This document and the solutions contained therein are the intellectual property of EVCO and thus protected by the Italian Intellectual Property Rights Code (CPI). EVCO imposes an absolute ban on the full or partial reproduction and disclosure of the content other than with the express approval of EVCO. The customer (manufacturer, installer or end user) assumes all responsibility for the configuration of the device.

EVCO accepts no liability for any possible errors in this document and reserves the right to make any changes at any time without prejudice to the essential functional and safety features of the equipment.