

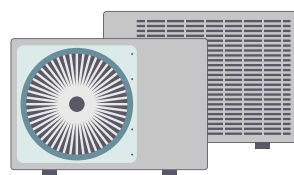

Applications



Heat pump

EVJBOX HP Sequencer

Application Manual:
Heat pump sequencer

- | Ready-to-install solution
- | LCD colour graphic display
- | 6 capacitive touch keys
- | Electrical panel with full IP65
- | Display of the main variables of each heat pump
- | Management of the main equipment functions
- | Management of up to 5 heat pumps
- | Automatic power modulation
- | Maximum number of active units set by parameter



IMPORTANT

*Read this document carefully before installation and take all precautions before using the device.
Keep this document with the device for future reference.
Only use the device in the ways described in this document.*



CONSIDER THE ENVIRONMENT

Please read this document carefully and save it.



DISPOSAL

The device must be disposed of according to local regulations governing the collection of electrical and electronic equipment.

Index

Introduction	5
Purchasing codes	6
Measurements	7
Installation	8
Electrical connections	9
EVLJBOX HP Sequencer - User interface	9
Description of connectors	9
EVLJBOX HP Sequencer - Control module	10
Description of connectors	10
Electrical connection	12
User interface	13
Keypad	13
List of pages	14
Password	14
Main page	15
Status pages	17
Main menu	18
User menu	18
Servicer menu	19
Installer menu	19
RTC menu	20
Alarm menu	21
Alarm history menu	21
Save/reset menu	21
Info menu	22
List of parameters	23
Description of parameters	23
Structure of the menus	23
Configuration parameters table	24
Regulations	28
Machine status	28
Setting the RTC	28
Main regulation	29
Slave on/off sequence	31
Slave status	31
Mixing valves	31

 Diagnostics	34
Manual and automatic alarms	34
Manual alarms	34
Automatic alarms	34
Table of alarms	35
Blocking alarms for the master	35
Blocking alarms for the slaves	35
Slave configuration alarm	37
Slave communication alarm	37
Evaporator high/low temperature alarm	38
Condenser high/low temperature alarm	39
 Technical specifications	40

Introduction

The **EVLJBOX HP Sequencer** is a control solution housed in an electric panel that makes it possible to control in sequence up to 5 heat pumps managed by **programmable EVCO devices** and interconnected with RS-485 serial communications systems. The number of operating units and their power level are adjusted according to the cooling/heating requirements of the equipment, but it is also possible to set parameters for the number of units active at the same time.

The fully IP65-compliant panel houses a user interface with a LCD graphic display with a resolution of 320x240 pixels and 16 colours, from which it is possible to manage all the main functions of the equipment (switch on/off, alter operating mode, etc.) and view the main variables of each of the connected heat pumps.



Purchasing codes

The table below shows the main features of the **EV LJBOX HP Sequencer** model available and the relative purchasing code

Features	Models
Power supply	
115... 230 VAC	•
Analogue digital inputs	
Evaporator supply water temperature probe (PTC/NTC/PT1000)	•
Evaporator return water temperature probe (PTC/NTC/PT1000)	•
Condenser supply water temperature probe (PTC/NTC/PT1000)	•
Condenser return water temperature probe (PTC/NTC/PT1000)	•
Analogue outputs	
Evaporator mixing valve (0-10 V/PWM)	•
Condenser mixing valve (0-10 V/PWM)	•
Digital outputs	
Heating/cooling switching valve 1	5 A
Heating/cooling switching valve 2	5 A
User interface	
320x240 px with LCD colour graphic display	•
Dimensions	
150x245 mm	•
Installation	
Wall mounted	•
Connections	
Fixed screw terminal blocks	•
Type A female USB connector	•
Communications ports	
RS-485 MODBUS MASTER	1
USB	1
Further features	
Clock	•

For more information see the section "Technical specifications"

Description of purchasing codes

Features	Code
115... 230 VAC - LCD graphic display - Wall mounted - RS-485 MODBUS - USB - Clock	

Measurements

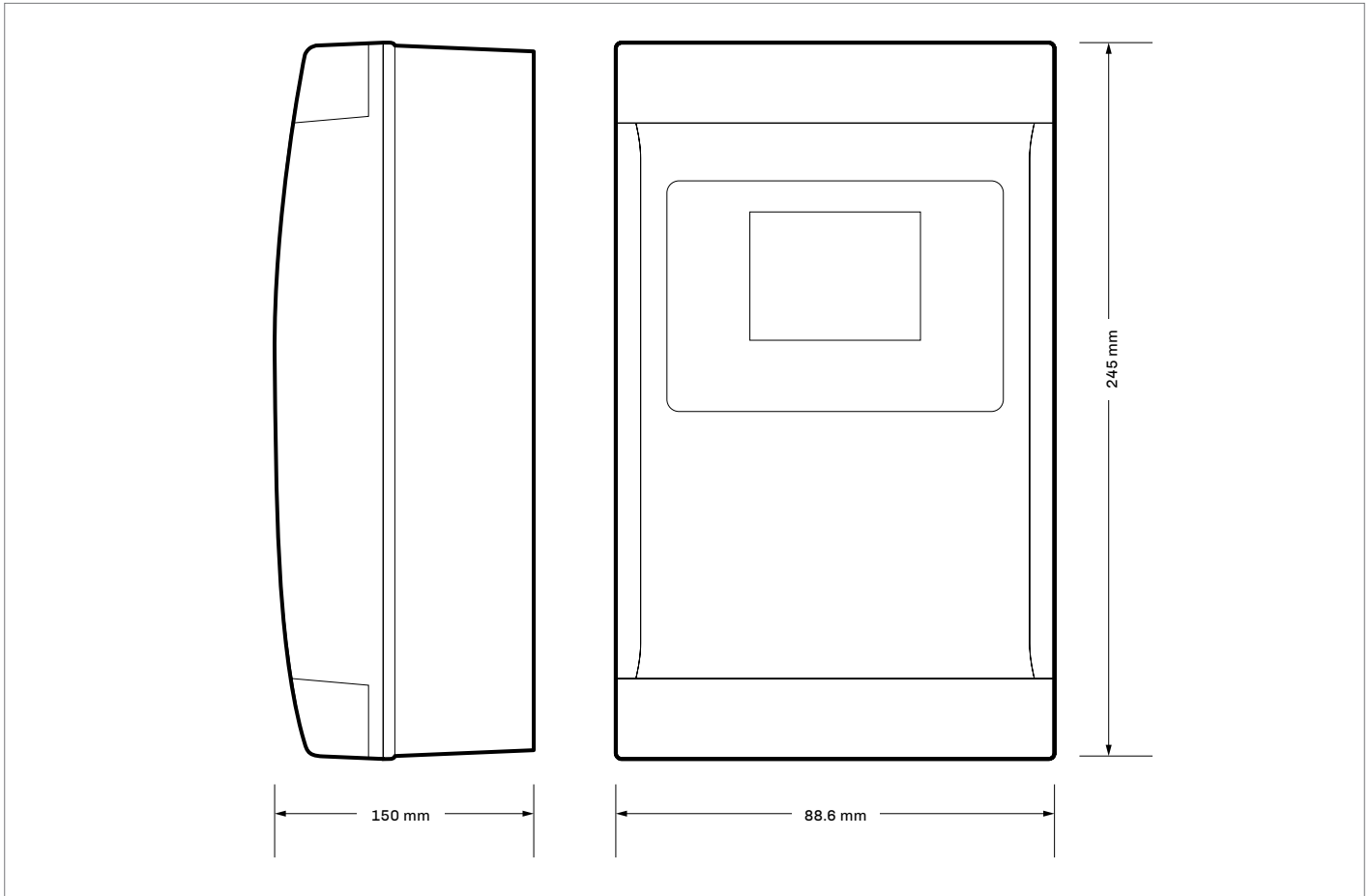

Installation



INSTALLATION PRECAUTIONS

- Ensure that the working conditions are within the limits stated in the "Technical specifications" section.
- Do not install the device close to heat sources, equipment with a strong magnetic field, in places subject to direct sunlight, rain, damp, excessive dust, mechanical vibrations or shocks.
- In compliance with safety regulations, the device must be installed properly to ensure adequate protection from contact with electrical parts. All protective parts must be fixed in such a way as to need the aid of a tool to remove them.
- Users will need a rigid pipe fitting; the maximum diameter of the fixing hole must be 28.5 mm
- To ensure IP65-rated protection of the whole casing, fix the container using only the holes already made

Wall mounting

1. Secure the back cover |7| to the wall using the 4 screws |1| and the holes already made |6|
2. Make sure the seal |8| is correctly inserted
3. Place the front cover |4| over the back cover |7| and push the 2 assembling tongues |10| down into the holes |2| on the right or left of the front cover |4|
4. Fix the user interface |12| into place by pressing it into its housing |5| from the front
5. Fix the control module |14| to the DIN rail |16|; next secure the DIN rail |16| to the back cover |7| in its housing |17| with two screws |15|
6. If the connection cables are fed in from above, make a hole whose diameter is suitable for fixing a rigid pipe fitting |13| on the top of the back cover |7|; if the cables are fed in from the bottom, make the hole on the bottom of the cover
7. Screw the rigid pipe fitting |13| to the back cover |7|
8. Connect the user interface |12| as shown in the section "Electrical connections", feeding the connection cables through the rigid pipe fitting |13|
9. Secure the front cover |4| to the back cover |7| using the 4 screws |9| and the holes already made |3|
10. Fix the covering strips |11| over the top and bottom parts of the front cover |4|

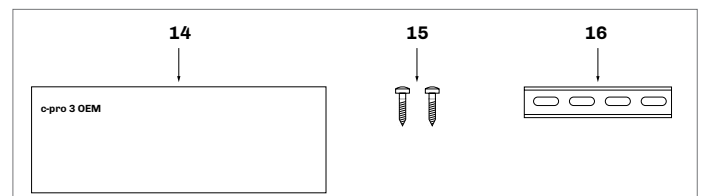
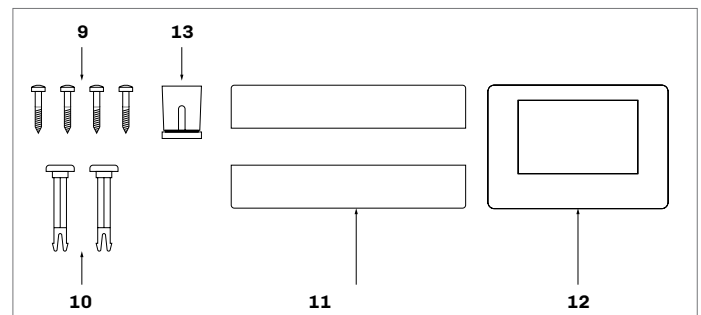
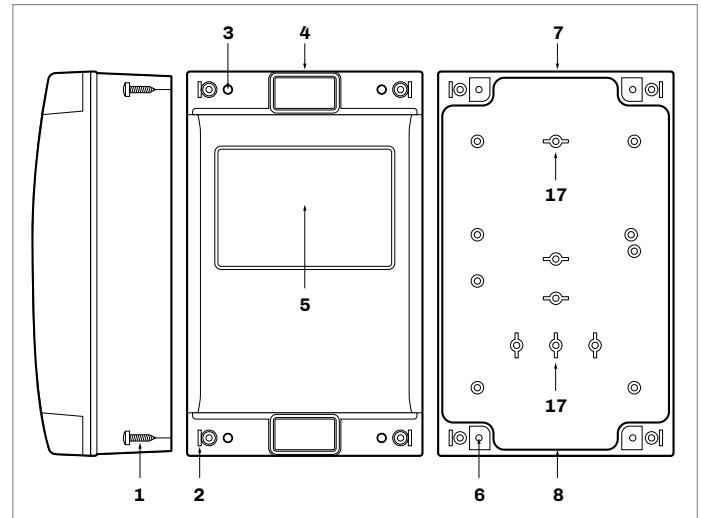

Electrical connections



PRECAUTIONS FOR ELECTRICAL CONNECTIONS

- Use cables of an adequate section for the current running through them
- To reduce any electromagnetic interference, connect the power cables as far away as possible from the signal cables and connect to a RS-485 MODBUS network using a twisted pair
- If using an electrical or pneumatic screwdriver, adjust the tightening torque
- If the device is moved from a cold to a warm place, humidity may cause condensation to form inside; wait for about an hour before switching on the power
- Make sure that the supply voltage, electrical frequency and power are within the set limits
- Disconnect the power supply before carrying out any type of maintenance
- Do not use the device as a safety device
- For repairs and further information, contact the EVCO sales network; returned goods without the data label will not be accepted

EVJBOX HP Sequencer - User interface

Description of connectors

Connector 1

Number	Description
1	- signal CAN port
2	+ signal CAN port
3	Device power supply (24 VAC/12... 30 VDC): if the device is powered by direct current, connect the negative terminal
4	Device power supply (24 VAC/12... 30 VDC): if the device is powered by direct current, connect the positive terminal

Connector 2

Number	Description
1	For EVCO use only

Micro-switch

Number	Description
2	To terminate the CAN network
1	For EVCO use only

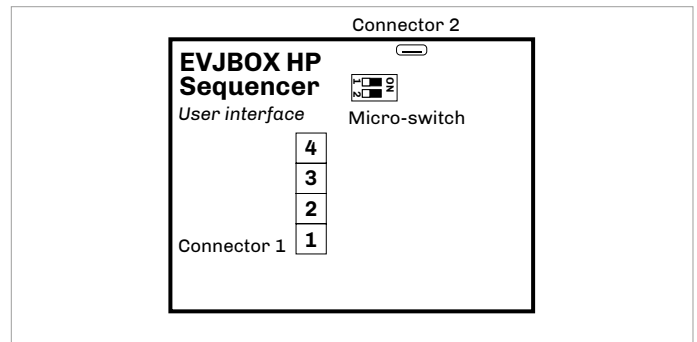

EV LJBOX HP Sequencer - Control module

Description of connectors

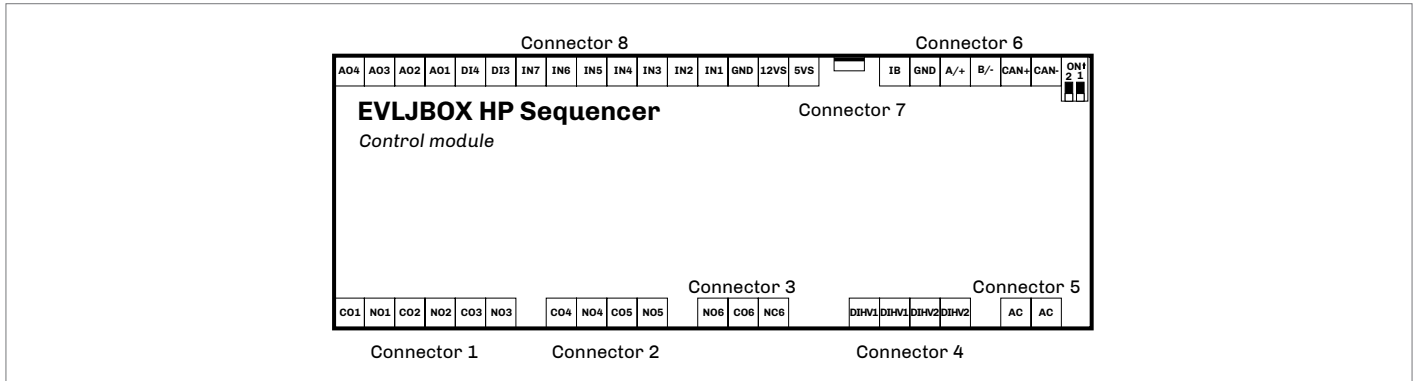

Connector 1

Number	Description
CO1	K1 digital output common contact
NO1	K1 digital output normally open contact (5 A res. at 250 VAC)
CO2	K2 digital output common contact
NO2	K2 digital output normally open contact (5 A res. at 250 VAC)
CO3	K3 digital output common contact
NO3	K3 digital output normally open contact (5 A res. at 250 VAC)

Connector 2

Number	Description
CO4	K4 digital output common contact
NO4	K4 digital output normally open contact (5 A res. at 250 VAC)
CO5	K5 digital output common contact
NO5	K5 digital output normally open contact (5 A res. at 250 VAC)

Connector 3

Number	Description
NO6	K6 digital output normally open contact (16 A res. at 250 VAC)
CO6	K6 digital output common contact
NC6	K6 digital output normally closed contact

Connector 4

Number	Description
DIHV1	DI1 high voltage digital input
DIHV1	DI1 high voltage digital input
DIHV2	DI2 high voltage digital input
DIHV2	DI2 high voltage digital input

Connector 5

Number	Description
AC	Device power supply (115... 230 VAC)
AC	Device power supply (115... 230 VAC)

Connector 6

Number	Description
IB	INTRABUS port data
GND	Reference (GND)
A/+	If installed, + signal RS-485 MODBUS master/slave port
B/-	If installed, - signal RS-485 MODBUS master/slave port
CAN+	+ signal CAN port
CAN-	- signal CAN port

Connector 7

Number	Description
USB	USB port to programme the device

Connector 8

Number	Description
AO4	AO4 analogue output (for 0-10 V or PWM signal)
AO3	AO3 analogue output (for 0-10 V or PWM signal)
AO2	AO2 analogue output (for 0-10 V or PWM signal)
AO1	AO1 analogue output (for 0-10 V or PWM signal)
DI4	DI4 digital input (dry contact and for pulse trains up to 2 KHz)
DI3	DI3 digital input (dry contact and for pulse trains up to 2 KHz)
IN7	AI7 analogue input (for PTC, NTC or Pt 1000 probes); can also be configured for DI11 dry contact digital input
IN6	AI6 analogue input (for PTC, NTC or Pt 1000 probes); can also be configured for DI10 dry contact digital input
IN5	AI5 analogue input (for PTC, NTC or Pt 1000 probes); can also be configured for DI9 dry contact digital input
IN4	AI4 analogue input (for PTC, NTC or Pt 1000 probes); can also be configured for DI8 dry contact digital input
IN3	AI3 analogue input (for NTC probes, 0-5 V, 0-10 V, 0-20 mA or 4-20 mA transd.); can also be configured for DI7 dry contact digital input
IN2	AI2 analogue input (for NTC probes, 0-5 V, 0-10 V, 0-20 mA or 4-20 mA transd.); can also be configured for DI6 dry contact digital input
IN1	AI1 analogue input (for NTC probes, 0-5 V, 0-10 V, 0-20 mA or 4-20 mA transd.); can also be configured for DI5 dry contact digital input
GND	Reference (GND)
12VS	Auxiliary power supply (12 VDC)
5VS	0-5 V ratiometric transducers power supply (5 VDC)



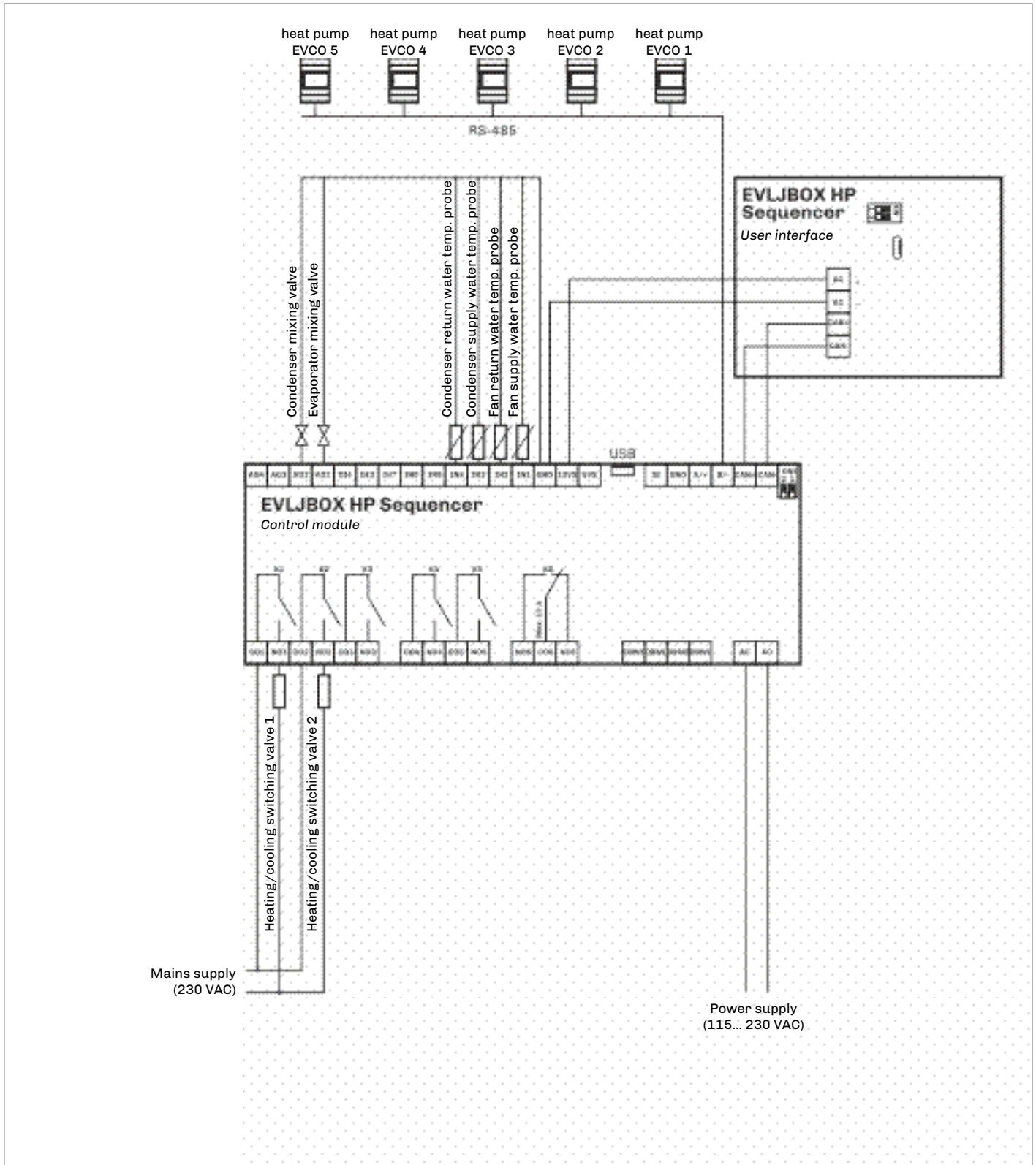

Electrical connection









User interface

Keypad

Description of keys

Keys	Instructions
	ON/STAND-BY
 	LEFT AND RIGHT
 	UP AND DOWN
OK	ENTER





Description of LEDs

LED	Instructions
 	ON/STAND-BY
 	ALARM
 	POWER

Switching the device on/off



Steps	Description
1	Connect to the power supply: an internal test will start up which will take a couple of seconds
2	Hold the ENTER key down for 2 seconds: the display will show the main screen
3	To switch off the device, disconnect it from the power supply

Access to menus

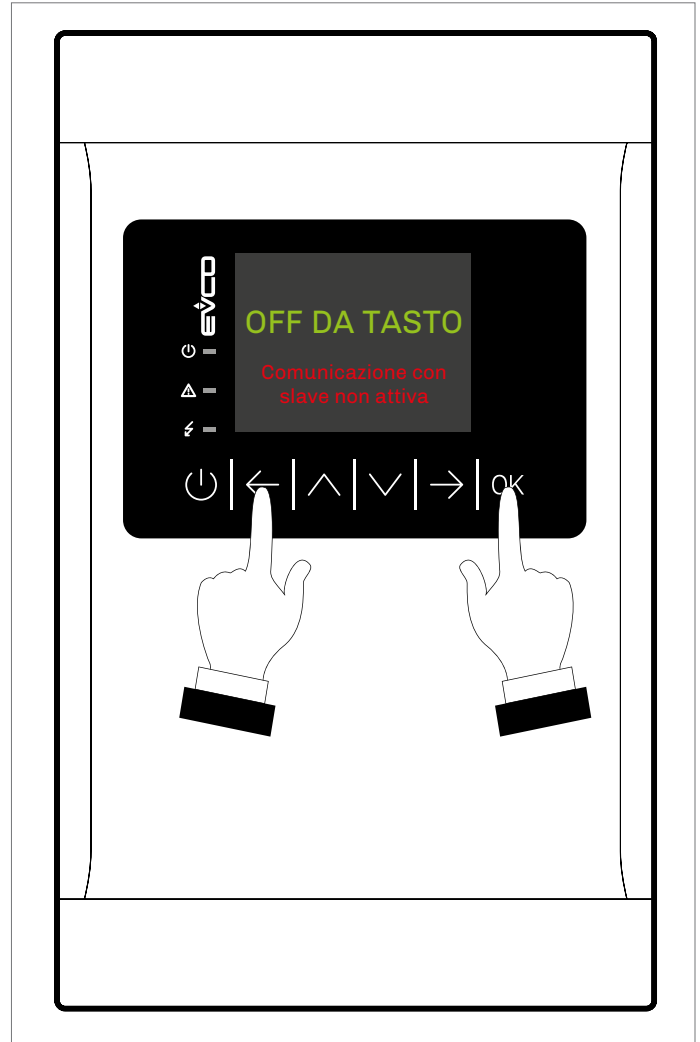
Keys	Instructions
OK	Hold the ENTER key down for 2 seconds: the display will show the main screen
 	Press the UP or DOWN key to select the menus
OK	Press the ENTER key to confirm the menu
OK	Press the ENTER key to access the value
 	Press the UP or DOWN key to set the value
OK	Press the ENTER key to confirm the value
	Press the ON/STAND-BY key a few times to return to the previous displays



Passwords

Keys	Instructions
OK	Hold the ENTER key down for 2 seconds: the display will show the main screen
	Press the DOWN key: the display will show the menu
OK	Press the ENTER key to confirm the menu. The display will show "enter password"
OK	Press the ENTER key to access the "password" value
 	Press the UP or DOWN key to set the password
OK	Press the ENTER key to confirm

List of pages

This section lists the main pages and menus used in the application.

The main menu has three levels:

- *User*
- *Servicer*
- *Installer*

USER menu - Level 1

- *Operating mode*
- *Summer setting*
- *Winter setting*
- *User password*

SERVICER menu - Level 2 (PW=1)

- *Counters*
- *I/O tests*
- *Calibration*
- *Input/output*
- *Password*

INSTALLER menu - Level 3 (PW=2)

- *Configuration*
- *Regulation*
- *Evaporator mixing valve section*
- *Condenser mixing valve section*
- *Security*
- *CAN*
- *MODBUS*
- *Default*
- *Miscellaneous*
- *Password*

RTC menu - Level 0

ALARM menu - Level 0

- *Master*
- *Slave*

HISTORY menu - Level 0

SAVE/RESET menu - Level 0

- *Flash drive*
- *Memory*

INFO menu - Level 0

Password

Each menu level sets the accessibility to the various functions and it is assigned a password.

Once the correct password has been entered, users can:

- *Access protected functions*
- *Unlock the level in question*
- *Unlock the various sublevels*

Level passwords can be changed by the same or higher levels.

Passwords of all the levels can be changed from the INSTALLER level.

The range of possible values to set passwords goes from -999/9999.

The password setting time frame expires after 4 minutes, after which it is necessary to set a new password.

Main page

Viewing of the "main page" changes according to machine status:

- If the sequencer is on "OFF by key" or "OFF by alarm"
- If the system is off or on



If a fault occurs in the control probe, the sequencer will go into the "OFF by alarm" state.



The control probe alarm, AL13 if the probe is that of the evaporator or AL15 if the probe is that of the condenser, has manual reset. Once the fault has been fixed and the alarm reset, the sequencer will automatically return to the condition prior to the alarm.



If the sequencer is on "OFF by key" or "OFF by alarm", MODBUS communication with the slaves is disabled. After 5 minutes, they will begin working autonomously and independently.

When the "ON/STAND-BY"  key is pressed for 2 seconds, MODBUS communication with the slaves will begin.

The "system off page" will be displayed on the sequencer with the following information:

- Active alarms in the master and relative number
 -  = no alarm active
 -  = at least one alarm active
- Current date and time
- Software version
- Command to switch on the sequencer system

To prevent the sequencer being accidentally switched on, which could cause problems with the sensitive MODBUS communication, press the "DOWN"  key before switching it on. The message "SYSTEM START-UP" will appear, press the "ENTER"  key to confirm.

Users can browse the machine status pages from this page using the "LEFT"  and "RIGHT"  keys:

- Master
- Slave

By holding down the "ON/STAND-BY"  key for 2 seconds on this page only, it is possible to disable MODBUS communication with the slaves.

Machine status will therefore be in "OFF by key".

If the sequencer is started up and MODBUS communication with all the slaves has not yet been established, the word "Initialisation" will flash underneath.

Once communication has been established, the sequencer's ON page will automatically be loaded.



"main page" with sequencer in "OFF by key"

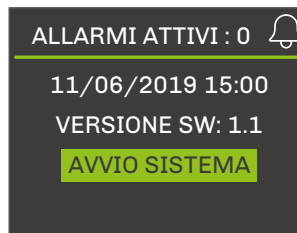

"system off page" with sequencer off







Sequencer switched on awaiting "Initialisation" of MODBUS communication with the slaves



When the sequencer is switched on, two main screens are available depending on the type of condenser configured in the slaves:

- If it is a water condenser the output temperature of both the condenser and the evaporator will be displayed
- If it is an air condenser only the evaporator temperature will be displayed

The following information is available on the main pages:

- Master status:
 -  = no alarm active
 -  = at least one minor alarm active
 -  = at least one blocking alarm active
- Number of active slaves if an alarm occurs with one of the slaves, the alarm icon will flash every 2 seconds
 -  = minor alarm
 -  = blocking alarm
- Condenser output temperature shown only with slave with water condenser
- Evaporator output temperature
- Power required by the system
- System power output
- Command to switch sequencer off

If there is an error with a probe or if it is disconnected, "---" will appear in the field for that value.

To prevent the sequencer being accidentally switched off, which could cause problems with the sensitive MODBUS communication, press the "DOWN"  key before switching it off. The message "STOP SYSTEM" will appear, press the ENTER  key to confirm.

When the "LEFT"  and "RIGHT"  keys are pressed on the "main page", information concerning the following will be displayed in sequence:

- Master
- Configured slaves
- Mixing valves in the system

Pressing the "ON/STAND-BY"  key from the main page will take you back to the "Alarm/History" page.





"main page" slave with water condenser



"main page" slave with air condenser

Status pages

“Master screen”





When the “LEFT”  and “RIGHT”  keys are pressed on the “system off” or “system on” screens, the individual status pages of only the configured slaves and mixing valves installed will be displayed.

The “master screen” will always be displayed.





“master screen”

This screen displays the following information regarding the master:

- Master status
 -  = no alarm active
 -  = at least one minor alarm active
 -  = at least one blocking alarm active
- Operating mode
 -  = summer/cooling
 -  = winter/heating
- Temperature of regulation probe
- Current setpoint and regulation neutral zone
- Power required by the master
- Slave power output
- Number of active slaves

“Slave screen”

This screen displays the following information regarding each slave:

- Slave status
 -  = no alarm active
 -  = at least one minor alarm active
 -  = at least one blocking alarm active
- Regulation status
 - ALARM = at least one blocking alarm is active in the slave
 - UNIT OFF = slave off
 - READY = slave enabled and ready for regulation
 - ACTIVE = slave currently used by regulation
 - FULL POWER = slave adjusted to maximum power
- Unit status
 - OFF KEY = slave switched off by a key
 - OFF DI = slave switched off by a digital input
 - OFF supervisor = slave switched off by the supervision protocol
 - OFF changeover = slave switched off due to an operating mode changeover
 - OFF defrost = slave switched off for defrosting
 - OFF programme = slave switched off by time bands programme
 - OFF alarm = slave switched off by alarm
 - OFF RTC = slave switched off due to RTC fault or dead battery
 - ON = slave on
- Slave operating hours
- Power requested to slave
- Slave power output
- Number of active compressors

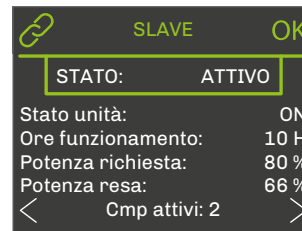

“slave screen”

“Evaporator mixing valve screen”

This screen displays the following information regarding the evaporator valve:

- Temperature of regulation probe
- Current regulation setpoint
- Regulation differential
- Regulation request
- Analogue output valve value

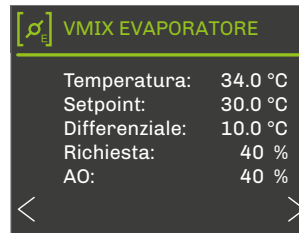

“evaporator mixing valve screen”

“Condenser mixing valve screen”

This screen displays the following information regarding the condenser valve:

- Temperature of regulation probe
- Current regulation setpoint
- Regulation differential
- Regulation request
- Analogue output valve value

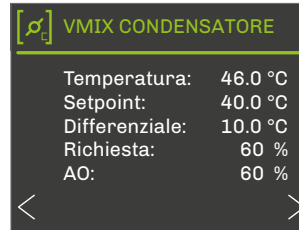

“condenser mixing valve screen”

Main menu

The “main menu” has no level and is the access point for all the other system menus.

It is possible to view the “main menu” from any point on the user interface by pressing “ENTER” for about 2 seconds.

It is possible to access the desired function by pressing the “UP” and “DOWN” keys from the “main menu”.

Press the “ENTER” key to confirm.

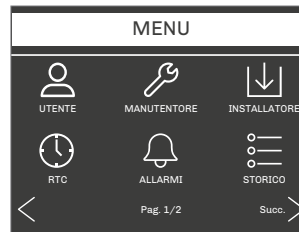

“main menu” page 1

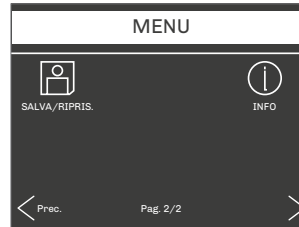

“main menu” page 2

User menu

The “user menu” is level 1 and it is therefore necessary to enter the user level password (or that of a higher level) to view/change the parameters in this section.

This section contains the following parameters:

- Operating mode
- Setpoint for summer operation
- Setpoint for winter operation
- User password

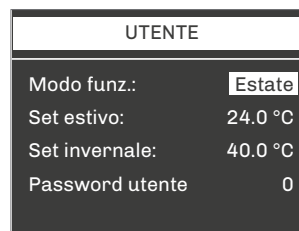





“user menu”

Service menu

The "service menu" is level 2 and it is therefore necessary to enter the service level password (or that of a higher level) to view/change the parameters in this section.

It is possible to view the status of the various devices and the inputs/outputs used by the application in this menu.

This section contains the following menus:

- "counters menu" 
 - the operating hours of the master and slaves can be viewed here
- "I/O test menu" 
 - simulation of the analogue inputs, the analogue outputs and the digital outputs can be enabled here.
- "calibration menu" 
 - corrections to be applied to the analogue inputs to compensate for the offsets due to the cabling and probe position can be set here
- "input/output menu" 
 - the physical board inputs and outputs can be viewed directly here
- "password menu" 
 - the service level (level 2) password can be set here

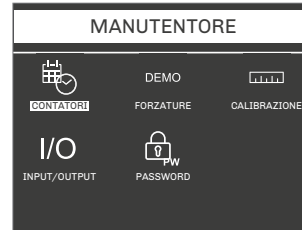

"service menu"





Installer menu

The "installer menu" is level 3 and it is therefore necessary to enter the installer level password (or that of a higher level) to view/change the parameters in this section.

All the parameters regarding the configuration of the functions can be found in the "installer menu", including:

- Alarms
- Regulations
- Logics
- Features

This section contains the following menus:

- "configuration menu" 
 - the following actions can be carried out in this menu:
 - set the total number of slaves to control
 - set the number of slaves in stand-by
 - enable the evaporator and condenser mixing valves
Changes to these parameters may cause problems with MODBUS communication with the slaves, so this menu can only be accessed when the machine is in "OFF by key" or "OFF by alarm"
- "regulation menu" 
 - the main regulation parameters can be set in this menu:
 - regulation neutral zone
 - time and percentage of increase/decrease of regulation in the neutral zone
 - consecutive operating time after which the slaves must be rotated
 - inversion of the analogue inputs/outputs of the mixing valves in winter mode
- "VMIX evaporator/condenser menu"  





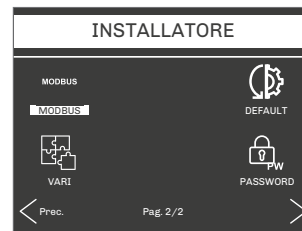



"installer menu " page 1



"installer menu " page 2

the parameters to manage the evaporator and condenser

mixing valves can be set in this menu

- "safety menu" 
 - all the parameters regarding the sequencer alarms can be found in this menu:
 - high/low temperature alarm setpoint and differentials
 - enabling
 - signalling delays
 - re-arm type
- "CAN menu" 
 - all the parameters to configure the CAN network can be viewed in this menu
- "MODBUS menu" 
 - all the parameters to configure the network on the RS-485 port can be viewed in this menu
- "default menu" 
 - the default values of all the application parameters can be reset in this menu
- "miscellaneous menu" 
 - this contains other general parameters such as:
 - enabling system start-up/stop by the supervisor
 - setting the language
 - setting the temperature measurement unit
 - deleting history
 - setting the minimum and maximum threshold values
- "password menu" 
 - the installer (level 3) password can be set in this menu

RTC menu

The "RTC menu" contains all the functions of the RTC (Real Time Clock) system.



"RTC menu"

Alarm menu

The "alarm menu" displays and resets master alarms and displays alarms in the configured slaves.
 Press the "UP" and "DOWN" keys to choose the device and view its alarms.
 Press the "ENTER" key to access the list of alarms selected.

The icons next to the name of the device indicate the alarm status:

- = no alarm active
- = at least one minor alarm active
- = at least one blocking alarm active

Press the "ENTER" key to view the next active alarm.
 If there are no alarms, the words "NO ALARMS" will appear on the screen.

Press the "ENTER" key for about 2 seconds to reset the alarm if the error conditions are no longer active.
 Press the "ON/STAND-BY" key or wait 60 seconds without pressing any key to return to the main page.

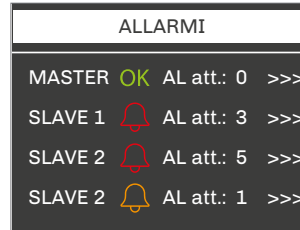

"alarm menu"

Alarm history menu

The "alarm history menu" displays the alarm history, showing the last sequencer alarm.

Press the "ENTER" key to view all the alarms in the history, up to the first one.
 The history display is circular.
 Press the "ON/STAND-BY" key or wait 60 seconds without pressing any key to return to the main page.



"alarm history menu"

Save/reset menu

The "save/reset menu" is level 3 and it is therefore necessary to enter the password of this level (or that of a higher level) to access the page to save or reset the parameters.

This section contains the following menus:

- "save parameters menu"
 this saves the map of the device's parameters on the controller's internal memory or on a FAT32 formatted USB flash drive.
- "reset parameters menu"
 this resets a map of the parameters that has previously been saved on the internal memory or a USB flash drive

In both menus it is possible to see if the USB flash drive has successfully been connected and recognised.

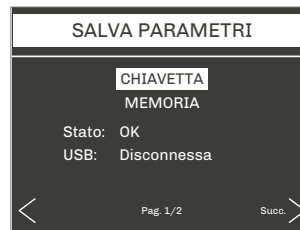

"save menu"

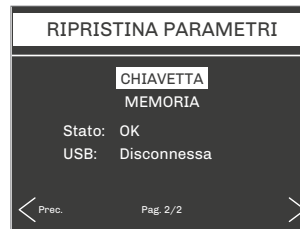

"reset menu"

Info menu

The "info menu" displays the information regarding the version of the project and the controller firmware, including:

- Project number
- Variation number
- Project version
- Project revision
- Project date
- Firmware number
- Firmware version
- Firmware revision

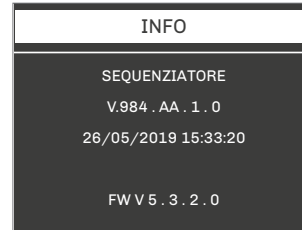

"info menu"

List of parameters

Description of parameters

Below is the list of parameters managed by the application.

The following are given for each parameter:

- a brief description
- the range of admissible values
- the unit of measurement
- the suggested default value
- the menu containing the parameter

Structure of the menus

Menu	Description	Parameters
UT	User menu	
MA	Servicer menu	
MA-C		Counters
MA-S		I/O test section
MA-CA		Calibration
MA-IO		Input/output
MA-PW		Password
IS	Installer menu	
IS-CF		Configuration
IS-R		Regulation
IS-E		Evaporator mixing valve
IS-CO		Condenser mixing valve
IS-S		Security
IS-CAN		CAN network
IS-M		MODBUS network
IS-D		Default
IS-V		Miscellaneous
IS-PW		Password

Configuration parameters table

When the machine parameters are configured or changes made to the configuration parameters, it is advisable to switch the machine off and restart the system to allow the board to configure itself correctly.

Code	Parameter description	Default	Min	Max	U.M.	Menu	Notes
Level 1	"User menu"						
MOdE	Operating mode: 0: Summer (Cooling) 1: Winter (Heating)	0	0	1		UT	Summer only: – if CHILLER slave – machine type only CHILLER
SEtC	Summer setpoint (Cooling)	24.0	PH05	PH06	°C	UT	
SEtH	Winter setpoint (Heating)	40.0	PH07	PH08	°C	UT	
PSd1	User level password (1)	0	-999	9999		UT	
Level 2	"Servicer menu"						
	Counters						
PM01	Master operating hours	0	0	99999	Hours	MA-C	
PM02	Slave 1 operating hours	0	0	99999	Hours	MA-C	
PM03	Slave 2 operating hours	0	0	99999	Hours	MA-C	
PM04	Slave 3 operating hours	0	0	99999	Hours	MA-C	
PM05	Slave 4 operating hours	0	0	99999	Hours	MA-C	
PM06	Slave 5 operating hours	0	0	99999	Hours	MA-C	
	I/O tests						
PS01	Enable analogue input simulation	NO (0)	NO (0)	YES (1)		MA-S	
PS02	Evaporator input temperature	24.6	-3276.8	3276.7		MA-S	
PS03	Evaporator output temperature	24.6	-3276.8	3276.7		MA-S	
PS04	Condenser input temperature	24.6	-3276.8	3276.7		MA-S	
PS05	Condenser output temperature	24.6	-3276.8	3276.7		MA-S	
PS06	Enable analogue output simulation	NO (0)	NO (0)	YES (1)		MA-S	
PS07	Evaporator mixing valve	0	0	100	%	MA-S	
PS08	Condenser mixing valve	0	0	100	%	MA-S	
PS09	Enable digital output simulation	NO (0)	NO (0)	YES (1)		MA-S	
PS10	Switching valve DO1	OFF (0)	OFF (0)	ON (1)		MA-S	
PS11	Switching valve DO2	OFF (0)	OFF (0)	ON (1)		MA-S	
	Calibrations						
PM80	Evaporator input temperature probe calibration	0.0	-10.0	10.0	°C	MA-CA	
PM81	Evaporator output temperature probe calibration	0.0	-10.0	10.0	°C	MA-CA	
PM82	Condenser input temperature probe calibration	0.0	-10.0	10.0	°C	MA-CA	
PM83	Condenser output temperature probe calibration	0.0	-10.0	10.0	°C	MA-CA	
	Password						
PSd2	Servicer password	1	-999	9999		MA-PW	
Level 3	"Installer menu"						
	Configuration						
PG01	Number of slaves	1	1	5		IS-CF	

Code	Parameter description	Default	Min	Max	U.M.	Menu	Notes
PG02	Number of slaves in stand-by	0	0	PG01		IS-CF	
PG03	Enable evaporator mixing valve	NO (0)	NO (0)	YES (1)		IS-CF	
PG04	Enable condenser mixing valve	NO (0)	NO (0)	YES (1)		IS-CF	
	Regulation						
Pr01	Regulation neutral zone	3.0	0.1	20.0	°C	IS-R	
Pr02	Percentage increase/decrease of regulation	5	0	100	%	IS-R	
Pr03	Time increase/decrease of regulation	5	1	100	Sec	IS-R	
Pr04	Slave rotation time	10	0	255	Hours	IS-R	
Pr05	Inversion mixing valves inputs/outputs in heating mode: 0: Inputs only 1: Outputs only 2: Inputs/Outputs	0	0	2		IS-R	
	Evaporator mixing valve						
PE01	Evaporator valve regulation probe: 0: T. input 1: T. output	0	0	1		IS-E	
PE02	Evaporator valve heating setpoint	30.0	0.0	70.0	°C	IS-E	
PE03	Evaporator valve heating differential	10.0	0.1	20.0	°C	IS-E	
PE04	Evaporator valve integral heating time	0	0	999	Sec	IS-E	
PE05	Evaporator valve minimum opening (output activation step)	0	0	PE06	%	IS-E	
PE06	Evaporator valve maximum opening	100	PE05	100	%	IS-E	
PE07	Evaporator valve polarity: 0: 0-10 V 1: 10-0 V	0	0	1		IS-E	
PE08	Evaporator valve cooling differential	10.0	0.1	20.0	°C	IS-E	
PE09	Evaporator valve integral cooling time	0	0	999	Sec	IS-E	
PE10	Kind of regulation evaporator valve 0: Minimum ON 1: Enabling step	0	0	1		IS-E	
	Condenser mixing valve						
PC01	Condenser valve regulation probe: 0: T. input 1: T. output	0	0	1		IS-CO	
PC02	Condenser valve cooling setpoint	30.0	0.0	70.0	°C	IS-CO	
PC03	Condenser valve cooling differential	10.0	0.1	20.0	°C	IS-CO	
PC04	Condenser valve integral cooling time	0	0	999	Sec	IS-CO	
PC05	Condenser valve minimum opening (output activation step)	0	0	PC06	%	IS-CO	
PC06	Condenser valve maximum opening	100	PC05	100	%	IS-CO	
PC07	Condenser valve polarity: 0: 0-10 V 1: 10-0 V	0	0	1		IS-CO	
PC08	Condenser valve heating differential	10.0	0.1	20.0	°C	IS-CO	
PC09	Condenser valve integral heating time	0	0	999	Sec	IS-CO	





Code	Parameter description	Default	Min	Max	U.M.	Menu	Notes
PC10	Kind of regulation condenser valve 0: Minimum ON 1: Enabling step	0	0	1		IS-E	
	Security						
PA01	Probe alarm delay	10	0	240	Sec	IS-S	
PA02	Evaporator low temperature alarm setpoint	-10.0	-15.0	PA04	°C	IS-S	
PA03	Evaporator low temperature alarm differential	5.0	0.1	20.0	°C	IS-S	
PA04	Evaporator high temperature alarm setpoint	60.0	PA02	70.0	°C	IS-S	
PA05	Evaporator high temperature alarm differential	5.0	0.1	20.0	°C	IS-S	
PA06	Condenser low temperature alarm setpoint	-10.0	-15.0	PA08	°C	IS-S	
PA07	Condenser low temperature alarm differential	5.0	0.1	20.0	°C	IS-S	
PA08	Condenser high temperature alarm setpoint	65.0	PA06	70.0	°C	IS-S	
PA09	Condenser high temperature alarm differential	5.0	0.1	20.0	°C	IS-S	
PA10	Enable RTC alarm	NO (0)	NO (0)	YES (1)		IS-S	
PA11	Type of RTC alarm re-arm: 0: Automatic 1: Manual	0	0	1		IS-S	
	CAN network						
PH09	CAN network local node	1	1	127		IS-CAN	
PH10	CAN Baud rate: 1: 20 KB 2: 50 KB 3: 125 KB 4: 500 KB	3	1	4	KB	IS-CAN	
	MODBUS network						
PH12	Baud rate of MODBUS communication: 0: 1200 1: 2400 2: 4800 3: 9600 4: 19200 5: 28800 6: 38400 7: 57600	3	0	7		IS-M	
PH13	MODBUS parity: 0: None 1: Odd 2: Even	2	0	2		IS-M	
PH14	MODBUS stop bit: 0: 1 stop bit 1: 2 stop bit	0	0	1		IS-M	
	Default						
PH15	Reset manufacturer's default parameters	NO (0)	NO (0)	YES (1)		IS-D	Wait for the NO (0) value on reset completion
	Other parameters						

Code	Parameter description	Default	Min	Max	U.M.	Menu	Notes
PH01	Enable system start-up/stop by the supervisor	NO (0)	NO (0)	YES (1)		IS-V	
PH02	Language: 0: English 1: Italian	0	0	1		IS-V	
PH03	Temperature unit of measurement: 0: Celsius 1: Fahrenheit	0	0	1		IS-V	
PH04	Delete alarm history	NO (0)	NO (0)	YES (1)		IS-V	Set YES (1) and wait for the NO value (0)
PH05	Minimum value summer setpoint (Cooling)	10.0	-15.0	PH06	°C	IS-V	
PH06	Maximum value summer setpoint (Cooling)	40.0	PH05	70.0	°C	IS-V	
PH07	Minimum value winter setpoint (Heating)	40.0	-15.0	PH08	°C	IS-V	
PH08	Maximum value winter setpoint (Heating)	70.0	PH07	70.0	°C	IS-V	
	Password						
PSd3	Password installer level (3)	2	-999	9999		IS-PW	

Regulations

Machine status

Procedures for switching the unit on and off:

1. Using the "ON/STAND-BY"  key on the EPJgraph user interface
 - Switch on - from the "system off" page to prevent it accidentally being switched on which could cause problems with the sensitive MODBUS communication.
When the "DOWN"  key is pressed, the words "SYSTEM START-UP" are highlighted in green
Press the "ENTER"  key to confirm switch-on
 - Switch off - from the "ON" page to prevent it accidentally being switched off
When the "DOWN"  key is pressed, the words "SYSTEM STOP" are highlighted in red
Press the "ENTER"  key to confirm switch-off
2. Using the supervision protocol (function enabled by parameter PH01)
To use this method, the sequencer must not be in "OFF by key" status.
 - Switch on - activate the switch-on status from the protocol.
The machine will switch on by itself
 - Switch off - deactivate the switch-on status from the protocol.
The machine will switch off by itself



N.B.!

Every time the sequencer goes from "OFF by key" to "system off", the application will check the type of application present in the slaves (HPRU or CHILLER) in order to set the correct MODBUS-slave communication. Temperature regulation in the neutral zone and MODBUS communication will be inhibited until the type of application of all the slaves configured by the PG01 parameter has been read.

If the application does not read the type of application of one or more slaves, the programme will continue to interrogate the address register every 5 seconds to prevent network overload.

Make sure all the slaves are connected before switching on the sequencer.

This may take as long as thirty seconds.

Setting the RTC

When the controller has been without power for a few days, the RTC (Real Time Clock) system clock loses the active time. When the controller is started up again, the right date and time must be set again.

Select the "RTC menu"  from the application's main menu and set the correct date and time.

If the clock loses the active time and the relative alarm is enabled (parameter PA10), the alarm "RTC AL11" will be set off. This alarm can be re-armed automatically or manually according to the configuration of parameter PA11:

- If automatic re-arm (PA11 = 0) has been configured,
just set the correct date and time to reset the alarm.
- If manual re-arm (PA11 = 1) has been configured,
the correct date and time must be set to reset the alarm, go to the alarm page and press "ENTER"  for 2 seconds

Main regulation

Main regulation is a regulation in the incremental neutral zone based on the differential from the temperature setpoint of the regulation temperature. The procedure will be different according to the operating mode set by parameter *MOdE*. Every time the operating mode changes, regulation is blocked for 30 seconds to prevent communication problems with the slaves.

When heat regulation is requested, a slave is activated and incremented up to 100%, according to the regulation timing set. It will then move on to the next slave, incrementing it by 100%, and continue in this manner until the maximum number of slaves configured have been incremented.

Vice versa, when the request for heat regulation expires, one slave is decreased to 0% and then deactivated. It will then move on to the next slave, decreasing it to 0%, and continue in this manner until it has run down all the configured slaves. It is possible to restrict the number of slaves to activate simultaneously by leaving the remaining slaves in stand-by through parameter *PG02*.

Two dedicated setpoints will be loaded according to the operating mode:

- Summer mode/cooling (*MOdE* = 0)
the summer setpoint set by parameter *SEtC* will be loaded
- Winter mode/heating (*MOdE* = 1)
the winter setpoint set by parameter *SEtH* will be loaded

In *CHILLER* slaves where the machine is a chiller only (*PG01* = 0 or *PG01* = 2), the operating mode is limited to summer mode only and any changes made to parameter *MOdE* will have no effect.

The application, which decides the regulation probe to use, will interrogate the slaves in a register called *MODBUS* to find out if they are reversible or non-reversible.

As regards *HPRU* slaves, the kind of condenser set by parameter *PF60* will be taken into consideration:

- if *PF60* = 0 (air) or *PF60* = 2 (water) the machine is reversible
- if *PF60* = 1 (water) the machine is not reversible

For *CHILLER* slaves, the type of machine set by parameter *PG01* will be taken into consideration:

- if *PG01* = 0 (Air-Water chiller only) or *PG01* = 2 (Water-Water chiller only) the machine is not reversible
- if *PG01* = 1 (Air-Water Chiller+HP) or *PG01* = 3 (Water-Water Chiller+HP) the machine is reversible

If the operating mode is set to winter (*MOdE* = 1) and the slaves are not reversible, the regulation probe will be the condenser output probe. In all other cases, the evaporator output probe will be taken into consideration.

Regulation will be blocked in the following cases:

- *MODBUS* communication not yet enabled after the sequencer has been switched on
- Regulation probe disconnected or showing an error
- Slave configuration alarm due to discrepancies between the types of slaves (*HPRU* and *CHILLER* in the same network) or between the types of condenser (air and water reversible/non reversible in the same network)

A request for heat regulation is made if:

- In summer: the regulation temperature is above the setpoint *SEtC* plus the neutral zone *Pr01/2*
- In winter: the regulation temperature is below the setpoint *SEtH* minus the neutral zone *Pr01/2*

The request will be met if:

- In summer: the regulation temperature is below the setpoint *SEtC* minus the neutral zone *Pr01/2*
- In winter: the regulation temperature is above the setpoint *SEtH* plus the neutral zone *Pr01/2*

The neutral zone is defined by the following parameters:

- M0dE: Operating mode
- SEtC: Summer/cooling setpoint
- SEtH: Winter/heating setpoint
- Pr01: Regulation neutral zone
- Pr02: Percentage increase/decrease of neutral zone regulation
- Pr03: Time increase/decrease of neutral zone regulation
- PG01: Number of slaves
- PG02: Number of slaves in stand-by

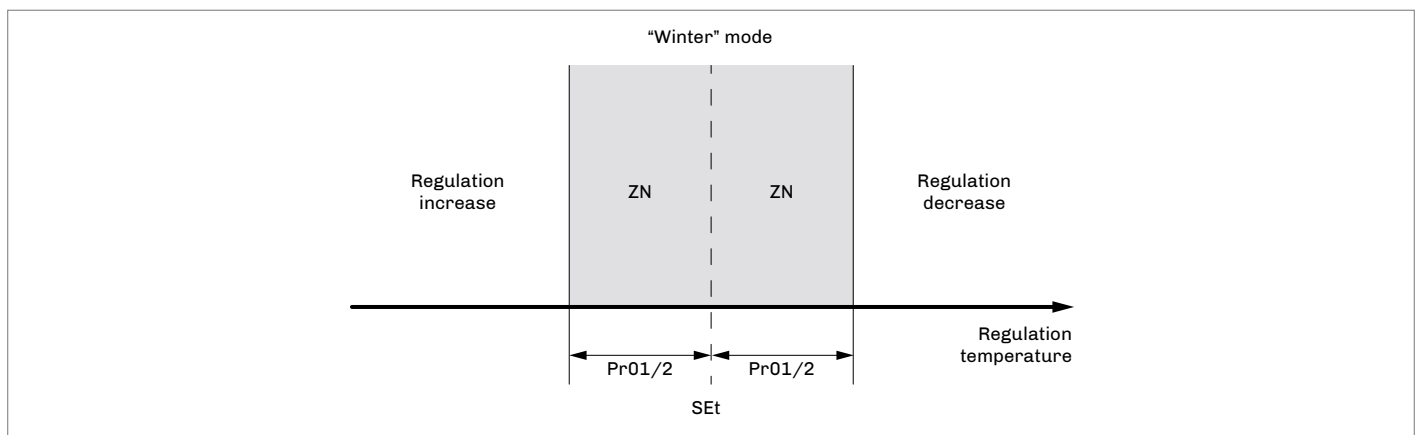
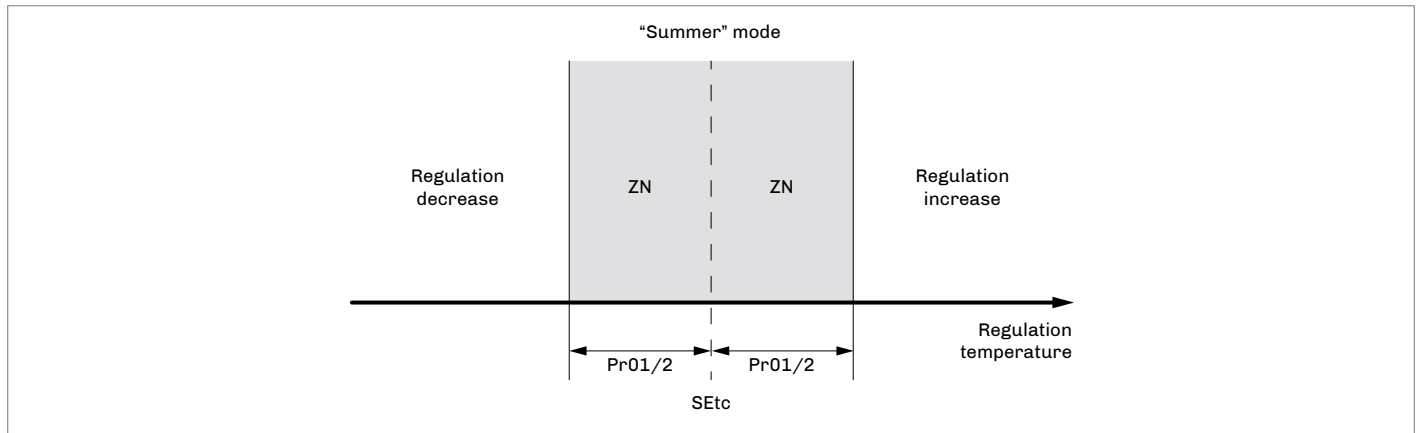



Slave on/off sequence

MODBUS communication enables the sequencer to obtain the alarms and status of every single slave.

When an active unit is in a blocking alarm situation or is switched off, the application instantly activates the first available unit, fulfilling the system's request for heat regulation.

The on/off sequence is based on the operating hours of the single slaves. It is possible to view them in the "servicer menu"

 --> counters section 

Irrespective of the number of active slaves, the first slave to be activated will be the one with the lowest number of operating hours, while the first one to be switched off will be the one with highest number of operating hours.

The application also rotates the slaves following a timing set by the consecutive operating parameter Pr04.

If a slave is active for longer than the value set by parameter Pr04, the operating hours of the available slaves are checked:

- If there is a slave with a lower number of operating hours than the active slave, the active slave will be switched off and the other one activated
- If there is no slave with a lower number of operating hours than the active slave, the slave which is already operating will remain active and a control will be carried out after a further consecutive period of operation Pr04.

Slave status

Each of the five configured slaves may be in one of the following status:

1. Disabled:
the slave has not been configured in the system
2. Alarm:
a blocking alarm has occurred in the slave so it is not available for regulating the sequencer
3. Off:
the slave is off and is not available for regulating the sequencer
4. Ready:
the slave is available and ready for regulation
5. Active:
the slave is currently regulated by the sequencer
6. Full power:
the slave is at maximum regulation

Mixing valves

The application also manages two mixing valves to control temperature:

- one for the evaporator which is enabled by parameter PG03
- one for the condenser which is enabled by parameter PG04

The type of regulation used is proportional-integral and loads a dedicated set of parameters according to the operating mode set by parameter MOdE.

When regulating, it is possible to select either the input or output probe of the exchanger through the following parameters:

- PE01 for the evaporator
- PC01 for the condenser

It is also possible to configure inversion of the analogue inputs and outputs between the two valves in winter mode through parameter Pr05. The following configurations are possible:

- Pr05 = 0 - inputs only
only the regulation probes of the valves will be inverted.
The regulation of the evaporator will be based on the condenser probe and vice versa
- Pr05 = 1 - outputs only:
the analogue outputs of the valves will be inverted.
The regulation of the evaporator will affect the analogue output of the condenser and vice versa
- Pr05 = 2 - inputs and outputs:
both the analogue inputs and outputs of the valves will be inverted.

It is possible to set the type of regulation of the mixing valve between "Minimum ON" and "enabling step" using the parameters:

- PE10 for the evaporator
- PC10 for the capacitor.

To use these adjustments, the minimum opening percentage of the mixing valve must be set using the parameters:

- PE05 for the evaporator
- PC05 for the capacitor.

If you have chosen the type of control Minimum ON ($PE10 / PC10 = 0$) the valve will always remain open by a minimum percentage regardless of the request. If the request exceeds the minimum opening value, the valve will assume the request value.

If you have chosen the type of enabling step regulation ($PE10 / PC10 = 1$), the output will remain at 0% in increase until the request becomes greater than the minimum value, then it will be kept at a minimum until the request is it will not go to 0%.

For both the valve analogue outputs, it is possible to set 0-10 V or 10-0 V polarity using the following parameters:

- PE07 for the evaporator
- PC07 for the condenser

The evaporator mixing valve is based on the following parameters and operates differently according to the operating mode:

- MOdE: Operating mode
- SETC: Summer/cooling setpoint
- PG03: Enable evaporator mixing valve
- Pr05: Inversion mixing valves inputs/outputs in winter mode
- PE01: Evaporator valve regulation probe
- PE02: Evaporator valve heating setpoint
- PE03: Evaporator valve heating differential
- PE04: Evaporator valve integral heating time
- PE05: Evaporator valve minimum opening (activation step)
- PE06: Evaporator valve maximum opening
- PE07: Evaporator valve polarity
- PE08: Evaporator valve cooling differential
- PE09: Evaporator valve integral cooling time
- PE10: Kind of regulation evaporator valve

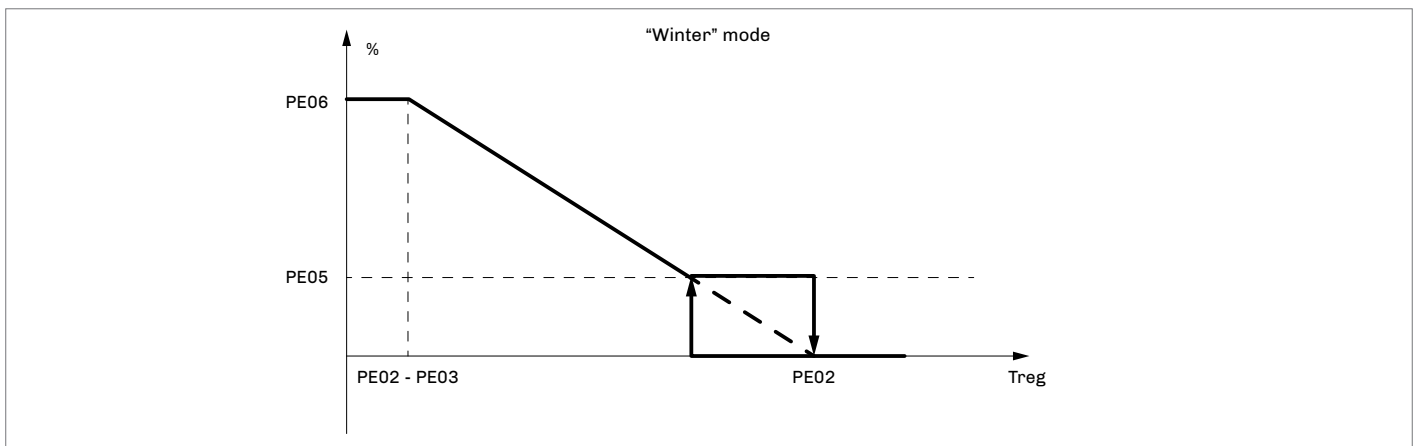
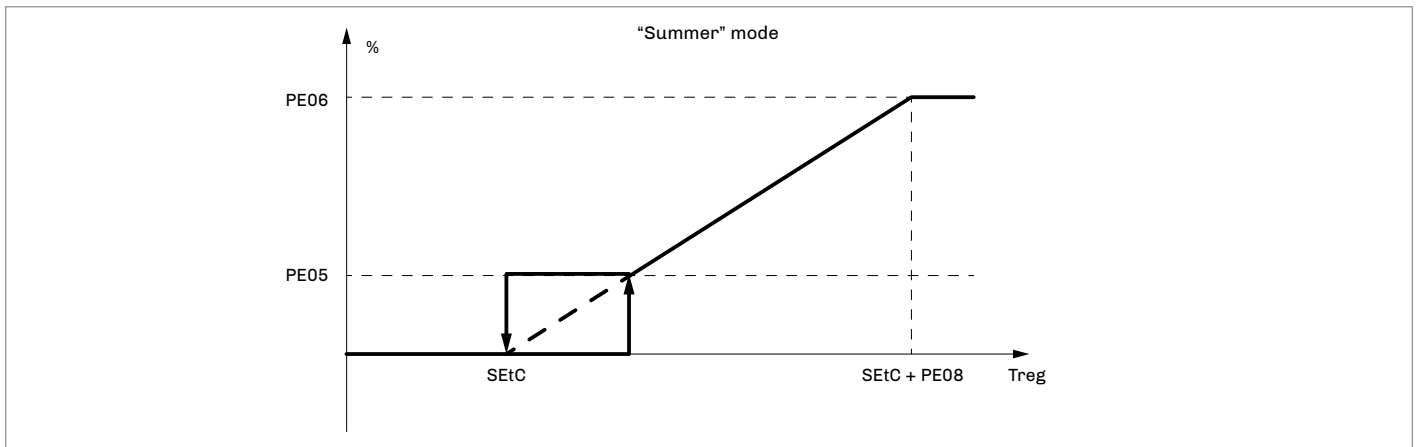

The condenser mixing valve is based on the following parameters and operates differently according to the operating mode:

- *MOdE*: Operating mode
- *SEtH*: Winter/heating setpoint
- *PG04*: Enable condenser mixing valve
- *Pr05*: Inversion mixing valves inputs/outputs in heating mode
- *PC01*: Condenser valve regulation probe
- *PC02*: Condenser valve cooling setpoint
- *PC03*: Condenser valve cooling differential
- *PC04*: Condenser valve integral cooling time
- *PC05*: Condenser valve minimum opening (activation step)
- *PC06*: Condenser valve maximum opening
- *PC07*: Condenser valve polarity
- *PC08*: Condenser valve heating differential
- *PC09*: Condenser valve integral heating time
- *PC10*: Kind of regulation condenser valve

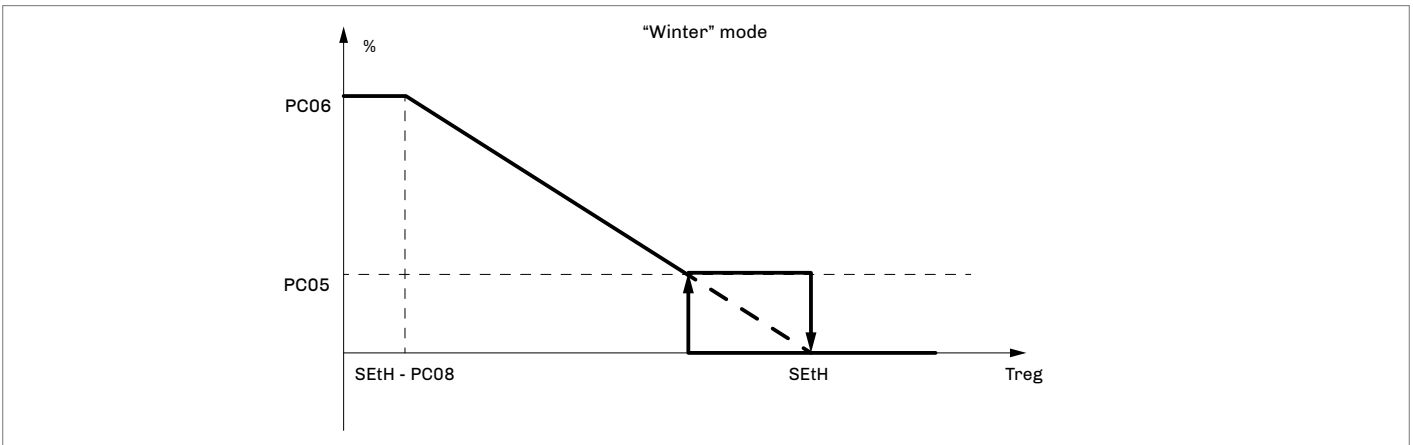
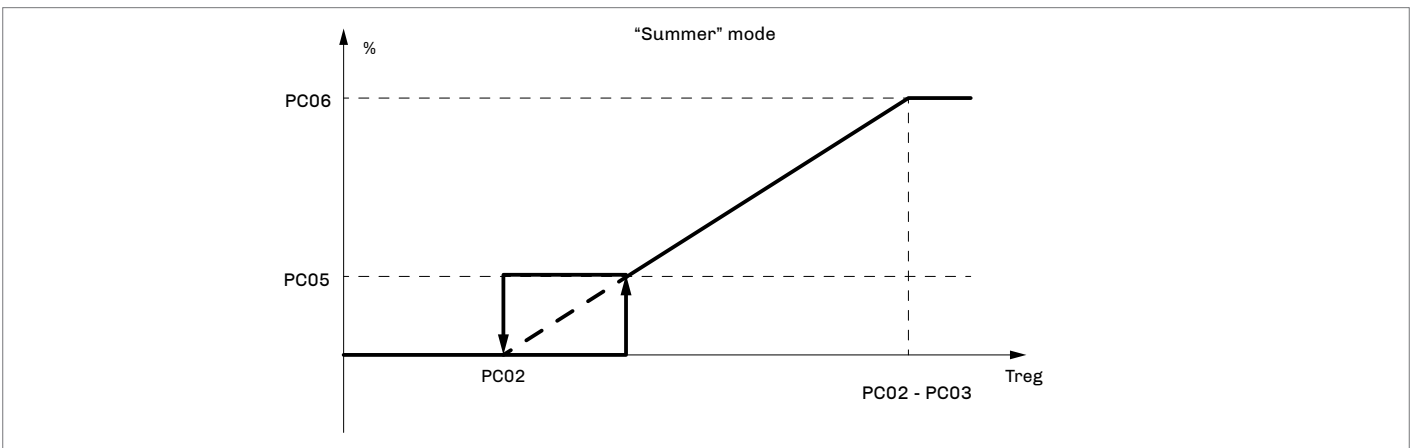

Diagnosics

The application is able to manage a set of alarms relating to the configuration and communication:

- of the slaves
- of the evaporator temperature
- of the condenser temperature
- and other machine functions

For the RTC alarm, it is possible to configure the type of manual or automatic re-arm through parameter PA11.

When the EPJgraph alarm LED flashes, it means there is at least one master alarm.

The programme only displays the slave alarms. To view the active alarms, select the slave in question.

The alarms can be viewed by accessing the "alarm menu"  or pressing the "ON/STAND-BY"  key on the desired device.

Press the "ON/STAND-BY"  key or wait for the 60 second timeout to view the main page.

Press the "ENTER"  key to view the active alarms which are displayed in order of priority.

Manual and automatic alarms

There are two types of alarm:



- Manual re-arm
- Automatic re-arm

These alarms allow the user to set the most suitable type of re-arm for his needs through a parameter.

Manual alarms

If a manual re-arm alarm is present:

- The alarm LED will start flashing.

Press the "ENTER"  key on the "alarm menu"  to view the code of the first active alarm.

Once the situation that triggered the alarm has been resolved, the alarm can be re-armed manually as follows:

- go to the page of the alarm to be reset
- hold down the "ENTER"  key for about 2 seconds.

If there are no other active alarms:

- The page with the words "NO ALARMS" will be displayed
- The alarm LED will switch off
- The machine will resume normal operation or the page referring to the next alarm will be displayed.

The consequences of an active manual alarm will remain valid until the alarm message is cancelled.



The only manual alarms in the programme are:

- Slave configuration alarm AL01
- Alarm RTC AL11, enabled and set, and with manual re-arm (PA11 = 1)
- Alarm evaporator output temperature probe
- Alarm condenser output temperature probe

Automatic alarms

When an automatic re-arm alarm is present:

- The alarm LED will start flashing

Press the "ENTER"  key on the "alarm menu"  to view the code of the first active alarm.

Once the situation that triggered the alarm has been resolved, re-arm and cancellation of the alarm message will happen automatically without the user having to take any action.

The consequences of an active automatic alarm will remain valid until the cause of the alarm has been resolved.

Table of alarms

The table below lists all the alarms managed by the application.
 The alarms are presented in the order in which the alarms are shown when active.
 The alarms can all be seen even with the machine switched off.

Code	Alarm description	Re-arm	Consequence	Delay
AL01	Slave configuration	Manual	– Inhibits main regulation – Inhibits MODBUS communication	60 seconds
AL02	Slave 1 communication	Automatic	– Inhibits regulation of slave 1	60 seconds
AL03	Slave 2 communication	Automatic	– Inhibits regulation of slave 2	60 seconds
AL04	Slave 3 communication	Automatic	– Inhibits regulation of slave 3	60 seconds
AL05	Slave 4 communication	Automatic	– Inhibits regulation of slave 4	60 seconds
AL06	Slave 5 communication	Automatic	– Inhibits regulation of slave 5	60 seconds
AL07	High evaporator temperature	Automatic	– Signal only	-
AL08	Low evaporator temperature	Automatic	– Signal only	-
AL09	High condenser temperature *)	Automatic	– Signal only	-
AL10	Low condenser temperature *)	Automatic	– Signal only	-
AL11	RTC faulty or disconnected	Auto/Manu **)	– Signal only	-
AL12	Evaporator input temperature probe	Automatic	– Inhibits regulation dependent on it	Can be set
AL13	Evaporator output temperature probe	Manual	– Inhibits regulation dependent on it – If regulation probe, it turns off all the devices and changes the status of the sequencer in "OFF by alarm"	Can be set
AL14	Condenser input temperature probe *)	Automatic	– Inhibits regulation dependent on it	Can be set
AL15	Condenser output temperature probe *)	Manual	– Inhibits regulation dependent on it – If regulation probe, it turns off all the devices and changes the status of the sequencer in "OFF by alarm"	Can be set

*) Alarms managed only with slaves with water condenser. If the slaves have an air condenser, they will be disabled

***) Automatic or manual alarm (can be set by parameter)

Blocking alarms for the master

The following alarms generate a blocking alarm for the master:

- Slave configuration alarm
- Communication alarm of all the configured slaves
- Regulation probe alarm

Blocking alarms for the slaves

The table below shows the blocking alarms which inhibit regulation of the slaves

Code	HPRU
AL01	Low temperature
AL02	High temperature
AL03	Flow switch
AL04	High pressure switch
AL05	Low pressure switch
AL06	High pressure transducer
AL07	Low pressure transducer
AL08	No start-up due to low pressure
AL09	Antifreeze
AC21	Compressor 1 thermal switch

Code	HPRU
AC22	Compressor 2 thermal switch
AC23	Compressor 3 thermal switch
AC26	Load pump thermal switch
AC27	Source pump thermal switch
AL11	Compressor discharge gas high temperature
AL18	EVCM
AL20	Inverter
AL27	Phase sequence
AL31	Water level
AC25	Fan 1 thermal switch (if PA84 = 2 or PA84 = 1)
AC31	Fan 2 thermal switch (if PA84 = 2 or PA84 = 1)

Code	CHILLER
AL01	Low input temperature
AL02	High input temperature
AL05	Evaporator flow switch
AL11	High pressure switch circuit 1
AL12	High pressure switch circuit 2
AL21	Low pressure switch circuit 1
AL22	Low pressure switch circuit 2
AL31	High pressure transducer circuit 1
AL32	High pressure transducer circuit 2
AL41	Low pressure transducer circuit 1
AL42	Low pressure transducer circuit 2
AL51	Low pressure start-up circuit 1
AL52	Low pressure start-up circuit 2
AL61	Compressor discharge gas high temperature circuit 1
AL62	Compressor discharge gas high temperature circuit 2
AL81	Evaporator antifreeze circuit 1
AL82	Evaporator antifreeze circuit 2
AC21	Thermal switch compressor 1 circuit 1
AC22	Thermal switch compressor 2 circuit 1
AC23	Thermal switch compressor 3 circuit 1
AC24	Thermal switch compressor 1 circuit 2
AC25	Thermal switch compressor 2 circuit 2
AC26	Thermal switch compressor 3 circuit 2
AP21	Thermal switch pump circuit 1
AP22	Thermal switch pump circuit 2
AP23	Thermal switch source pump circuit 1
AP24	Thermal switch source pump circuit 2
AF21	Thermal switch fan circuit 1
AF22	Thermal switch fan circuit 2

Code	CHILLER
AL06	Source flow switch
AL83	Source antifreeze circuit 1
AL84	Source antifreeze circuit 2
EVM1	EVCM circuit 1
EVM2	EVCM circuit 2
AL07	Phase sequence
AL08	Water level

Slave configuration alarm

When the application in the slaves or the type of condenser are not the same for all the configured slaves, the slave configuration alarm will be signalled AL01.

This alarm can be set off when HPRU slaves and CHILLER slaves are connected in the same network or when different types of condenser have been configured in the same network (as in the case of slaves with an air condenser together with slaves with a water condenser).

This alarm will be bypassed when switching on and after a 60 second re-arm to enable all the MODBUS registers in the network to be correctly read.

The consequences of manual re-arm alarm are:

- Inhibition of temperature regulation
- Inhibition of MODBUS communication with the slaves

Slave communication alarm

When the sequencer does not receive a response from the slave for more than 60 seconds, the slave communication alarm will be signalled (AL02..AL06 according to the slave).

This is an automatic re-arm alarm and will inhibit the sequencer from regulating the same slave.

Evaporator high/low temperature alarm

If the value of the evaporator input or output temperature exceeds the setpoint set by parameter PA04, the evaporator high temperature alarm will be signalled AL07.

This is an automatic re-arm alarm and is view only. It will have no repercussions on regulations.

The alarm will be reset when both the input and output temperatures drop below the value set by parameter PA04 minus the differential set by parameter PA05.

If the units are reversible and in heating mode, the setpoint and high temperature differential of the condenser set by parameters PA08 and Pa09 respectively will be used to control this alarm.

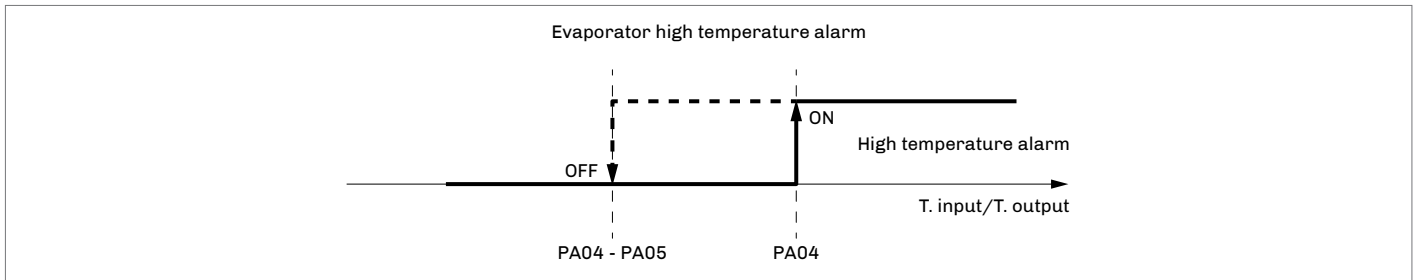

If the value of the evaporator input or output temperature falls below the setpoint set by parameter PA02, the evaporator low temperature alarm will be signalled AL08.

This is an automatic re-arm alarm and is view only. It will have no repercussions on regulations.

The alarm will be reset when both the input and output temperatures exceed the setpoint set by parameter PA02 plus the differential set by parameter PA03.

If the units are reversible and in heating mode, the setpoint and low temperature differential of the condenser set by parameter PA06 and PA07 respectively will be used to control this alarm.

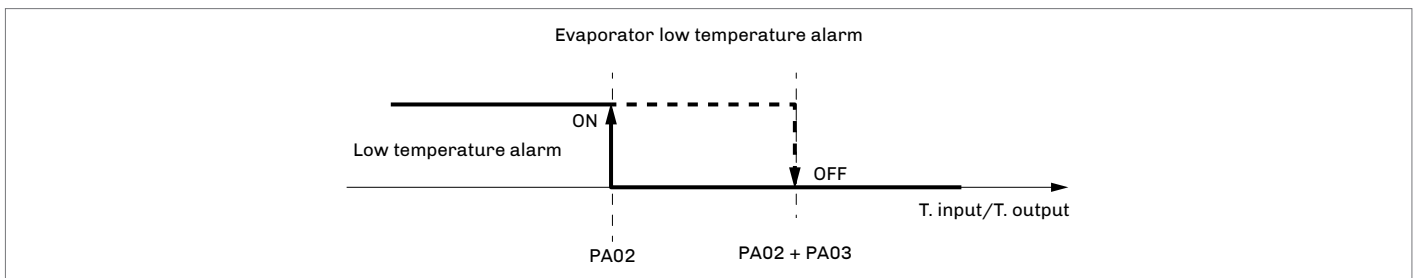

Condenser high/low temperature alarm

These alarms are managed by the application only when there are slaves with a water condenser.

If the value of the condenser input or output temperature exceeds the setpoint set by parameter PA08, the condenser high temperature alarm will be signalled AL09.

This is an automatic re-arm alarm and is view only. It will have no repercussions on regulations.

The alarm will be reset when both the input and output temperatures drop below the value set by parameter PA08 minus the differential set by parameter PA09.

If the units are reversible and in heating mode, the setpoint and high temperature differential of the evaporator set by parameters PA04 and Pa05 respectively will be used to control this alarm.

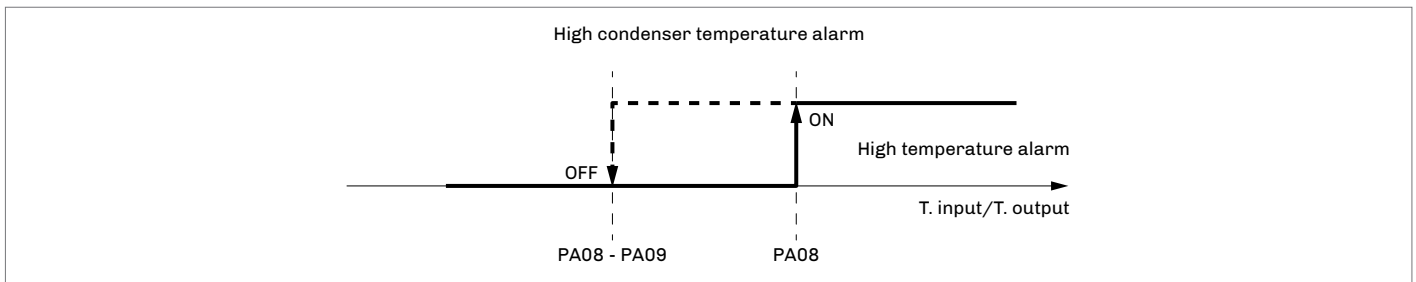

If the value of the condenser input or output temperature falls below the setpoint set by parameter PA06, the condenser low temperature alarm will be signalled AL10.

This is an automatic re-arm alarm and is view only. It will have no repercussions on regulations.

The alarm will be reset when both the input and output temperatures exceed the setpoint set by parameter PA06 plus the differential set by parameter PA07.

If the units are reversible and in heating mode, the setpoint and low temperature differential of the evaporator set by parameters PA02 and PA03 respectively will be used to control this alarm.

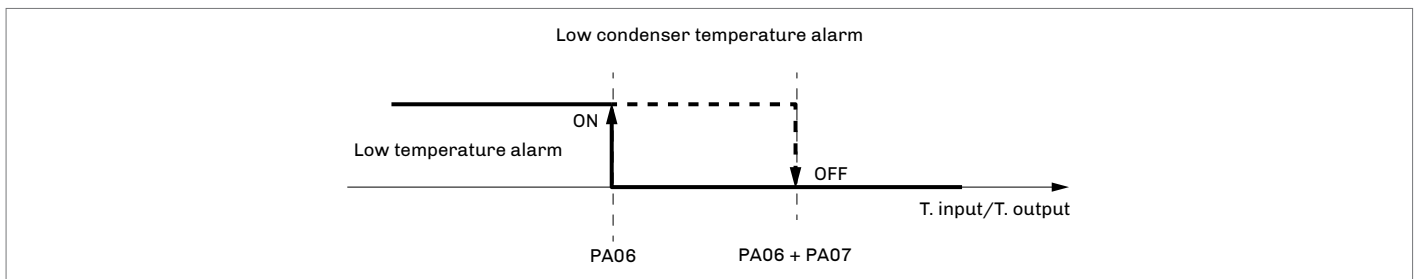

Technical specifications

Type	Description	
Purpose of the control device	Function controller	
Construction of the control device	Built-in electronic device	
Housing	White, self-extinguishing	
Category of heat and fire resistance	D	
Measurements	150 x 245 x 88.6 mm	
Mounting methods for the control device	Wall mounted with fixing screws (not provided)	
Degree of protection provided by the casing	IP65	
Connection method	Fixed screw terminal blocks for wires up to 2.5 mm ² Type A female USB connector	
Maximum permitted length for connection cables	Power supply: 10 m	
	Analogue inputs: 10 m	
	Digital outputs: 10 m	
Operating temperature	-10 – 55 °C	
Storage temperature	-20 – 70 °C	
Operating humidity	Relative humidity without condensate from 5 to 15%	
Pollution status of the control device	2	
Compliance	RoHS 2011/65/EC	
	WEEE 2012/19/EU	
	REACH (EC) Regulation no. 1907/2006	
	EMC 2014/30/EU	
	LVD 2014/35/EU	
Power supply	115... 230 VAC (+10 % -15 %) 50/60 Hz (±3 Hz) max. 10 VA	
Earthing methods for the control device	None	
Rated impulse-withstand voltage	4 KV	
Over-voltage category	III	
Software class and structure	A	
Clock	Built-in secondary lithium battery	
Clock drift	≤ 60 s/month at 25 °C	
Clock battery autonomy in the absence of a power supply	> 6 months at 25 °C	
Clock battery charging time	24 h (the battery is charged by the power supply of the device)	
Analogue inputs	4 for PTC, NTC or Pt 1000 probes	
PTC probes	Sensor type	KTY 81 – 121 (990 Ω @ 25 °C)
	Measurement field	-50 – 150 °C
	Resolution	0.1 °C
NTC probes	Sensor type	β3435 (10 KΩ @ 25 °C)
	Measurement field	-50 – 120 °C
	Resolution	0.1 °C
Pt 1000 probes	Sensor type	1 KΩ – 0 °C
	Measurement field	-100 – 400 °C
	Resolution	0.1 °C
Analogue outputs	2 for 0-10 V or PWM signal	
0-10 V signal	Minimum applicable impedance	1 KΩ
	Resolution	0.01 V
PWM signal	Power supply	0... 10 VDC (+16 % -25 %) 10 mA max
	Frequency	10 Hz... 2 KHz
	Duty	0... 100 %

Type	Description
Digital outputs	2 with SPST electro-mechanical relay, 5 A res. at 250 VAC
The device guarantees reinforced insulation between each digital output connector and the rest of the components of the device.	
Type 1 or Type 2 actions	Type 1
Additional features of Type 1 or Type 2 actions	C
Displays	320x240 px with LCD colour graphic display
Communications ports	RS-485 MODBUS MASTER
	INTRABUS
	USB



EVCO S.p.A.

Via Feltre 81, 32036 Sedico (BL) ITALY

| Tel. +39 0437 8422

| Fax +39 0437 83648

| e-mail info@evco.it

| web www.evco.it

This document and the solutions contained therein are the intellectual property of EVCO and thus protected by the Italian Intellectual Property Rights Code (CPI). EVCO imposes an absolute ban on the full or partial reproduction and disclosure of the content other than with the express approval of EVCO. The customer (manufacturer, installer or end user) assumes all responsibility for the configuration of the device.

EVCO accepts no liability for any possible errors in this document and reserves the right to make any changes at any time without prejudice to the essential functional and safety features of the equipment.