



Vcolor 819/829

Controllers for top-class blast chillers, in split version that can be built into the unit, with 5- or 7-inch colour TFT touch-screen graphic display in either vertical or horizontal format



ENGLISH

INSTALLER MANUAL ver. 5.0

CODE 144VC819E504

Important

Read this document carefully before installation and before using the device and take all the prescribed precautions. Keep this document with the device for future consultation.

The following symbols are used in this document:

💡 indicates a suggestion

⚠ indicates a warning.

The device must be disposed of according to local regulations governing the collection of electrical and electronic waste.



Index

1	INTRODUCTION	6
1.1	Introduction	6
1.2	Main features of the models available and their purchasing codes	7
2	DESCRIPTION.....	10
2.1	User interface description.....	10
2.2	Control module description.....	12
3	MEASUREMENTS AND INSTALLATION	13
3.1	Vcolor 819M user interface measurements	Errore. Il segnalibro non è definito.
3.2	Vcolor 819L user interface measurements	Errore. Il segnalibro non è definito.
3.3	Control module measurements	14
3.4	Multi-functional module measurements.....	14
3.5	User interface installation.....	15
3.6	Control and multi-functional module installation.....	15
3.7	Installation precautions.....	15
4	ELECTRICAL CONNECTION	16
4.1	Electrical connection of Vcolor 819M.....	16
4.2	Electrical connection of Vcolor 819L.....	18
4.3	Precautions for electrical connection	19
5	USER INTERFACE	20
5.1	Initial information	20
5.2	Initial switch-on.....	20
5.3	Switching the device on and off	21
5.4	Lock/unlock keypad.....	22
5.5	Silencing the buzzer	22
5.6	Door-open signal.....	22
6	FUNCTION MODES	23
6.1	Initial information on operating cycles	23
6.2	Initial information on the needle probe	23
6.3	Selecting the operating mode	24
7	BLAST-CHILLING MODE	25
7.1	Blast chilling/blast-freezing and conservation	26
7.2	Hard blast chilling/soft blast-freezing and conservation.....	28
7.3	Continuous cycle.....	28
7.3.1	Multineedle probe mode	29
7.3.2	Multi-timer mode.....	29
7.4	Customized cycle	30
7.5	Setting the set points	31
7.5.1	Setting the cabinet temperature set point.....	31
7.5.2	Setting the product temperature set point	31
7.5.3	Setting the cycle duration.....	31
7.5.4	Setting the fan speed.....	32
7.6	Running the cycle.....	32
7.6.1	Needle probe insertion test.....	33
7.6.2	Recording historical data	33
7.6.3	Cycle end	34
8	SPECIAL CYCLES MODE	36
8.1	Fish sanitation	37

8.2	Thawing	39
8.3	Defrosting	41
8.4	Ice cream hardening.....	42
8.5	Cabinet sterilisation.....	43
8.6	Heating the needle probe	43
8.7	Drying	44
8.8	Proofing	45
8.8.1	Description of proofing	45
8.8.2	Setting up a proofing cycle	45
8.9	Slow cooking	47
9	RECIPE BOOK MODE.....	48
9.1	Pre-set blast chilling recipes	50
9.2	Pre-set blast-freezing recipes	51
9.3	Saving a recipe.....	51
9.4	Over-writing a recipe.....	52
10	PRE-COOLING MODE	53
11	ADJUSTMENTS.....	54
11.1	Door frame heating output	54
11.2	Compressor management.....	54
11.3	Pump down solenoid valve management	55
11.4	Evaporator fan management.....	55
11.5	Condenser fan management	56
11.6	Alarm output management.....	56
11.7	Needle probe heating management	56
11.8	Cabinet sterilisation management.....	57
11.9	Defrost output management.....	57
11.10	Thawing heater management.....	57
11.11	Proofing and slow cooking heater management.....	57
11.12	Humidifier management.....	57
11.13	Humidifying/steam generator heater management	57
11.14	Cabinet light management.....	57
12	SETTINGS	58
12.1	Service	58
12.2	Setup	58
12.3	Select language	58
13	USING THE USB PORT	59
13.1	Initial information.....	59
13.2	Download/upload recipes	59
13.3	Download/upload parameters	60
13.4	Download HACCP data	60
14	EPOCA CLOUD PLATFORM	61
15	LIST OF CONFIGURATION PARAMETERS	62
16	ALARMS	73
16.1	Alarms	73
16.2	HACCP alarms.....	78
17	ACCESSORIES	79
17.1	EVIF25SWX - EVlink Wi-Fi module.....	79
17.2	EVC20P52N9XXX10 - Multi-functional module	79
17.3	ECTSFD004 - 230 VAC/12 VAC 20 VA safety transformer	79

17.4	EVIF20SUXI - Non-optoisolated RS-485/USB serial interface	80
17.5	0812000002 - USB plug for panel installation	80
17.6	0810500018/0810500020 - Connecting cables	80
17.7	EVDFAN1 - Phase cutting speed regulator for single-phase fans	81
17.8	EVUSB4096M - 4GB USB flash drive	81
18	TECHNICAL SPECIFICATIONS	82
18.1	Technical specifications	82

1 INTRODUCTION

1.1 Introduction

The Vcolor 819/829 series is a range of stylish controllers for managing top-class blast chillers.

Available in split version, the user interface can be installed recessed from the front or flush with the panel thus making it fit perfectly with the design of the unit. It consists of a 5-inch (Vcolor 819M) or 7-inch (Vcolor 819L) capacitive TFT touch-screen graphic display, in either vertical or horizontal format. The display features 65K colours, 800 x 480 pixel resolution and guarantees IP65 protection, for easy cleaning.

These controllers can run positive and negative blast chilling cycles, both temperature and time controlled, with hard/soft and blast chilling intensity management functions, the latter requiring an external fan speed regulator. Before each temperature cycle, a test is run to check that the needle probe is correctly inserted (including multipoint probes).

An external multi-functional module makes it possible to transform the blast chiller into a multi-functional device for managing retarding-proofing and slow cooking cycles. It is also possible to team a slow cooking function with subsequent holding or blast chilling and conservation functions.

The Wi-Fi connectivity (conveyed by the external interface EVlink Wi-Fi) enables the interaction with the unit respectively from the Internet via the cloud platform EPoCA. For more details, please check out the section "Products/Remote management and monitoring systems" in our website.

1.2 Main features of the models available and their purchasing codes

The table below shows the main features of the models available and the purchasing codes.

MAIN FEATURES	AVAILABLE MODELS AND KIT PURCHASING CODES		OPTIONS
	Vcolor 819M/829M (5")	Vcolor 819L/829L (7")	multi-functional module EVC20P52N9XXX10
Power supply			
control module	115... 230 VAC	115... 230 VAC	
user interface with separate power supply		12 VAC	
user interface powered by control module	•		
additional module			115...230 VAC
Analogue inputs			
cabinet probe	PTC/NTC	PTC/NTC	
needle probe (sensor 1)	PTC/NTC	PTC/NTC	
needle probe (sensor 2)	PTC/NTC	PTC/NTC	
needle probe (sensor 3)	PTC/NTC	PTC/NTC	
evaporator probe	PTC/NTC	PTC/NTC	
condenser probe	PTC/NTC	PTC/NTC	
Digital inputs			
door switch	•	•	
compressor thermal switch	•	•	
low pressure switch	•	•	
high pressure switch	•	•	
Analogue outputs			
PWM, for speed regulators (evaporator fan)	•	•	

MAIN FEATURES	AVAILABLE MODELS AND KIT PURCHASING CODES		OPTIONS
	Vcolor 819M/829M (5")	Vcolor 819L/829L (7")	multi-functional module
			EVC20P52N9XXX10
Digital outputs electro-mechanical relays; A res. @ 250 VAC			
compressor	30 A	30 A	
defrost	8 A	8 A	
evaporator fan	8 A	8 A	
condenser fan	8 A	8 A	
door heater	8 A	8 A	
thawing heater	16 A	16 A	
alarm (configurable) (1)	16 A	16 A	
pump down valve (configurable) (2)	8 A	8 A	
needle probe heater (configurable) (3)	8 A	8 A	
cabinet heater			30 A
steam generator			16 A
steam injection			8 A
Communications ports			
RS-485 MODBUS	•	•	
USB	•	•	
Other features			
Management via the EPoCA cloud platform using the Wi-Fi (EVlink Wi-Fi) interface	•	•	
clock	•	•	
alarm buzzer	•	•	
management of positive and negative blast chilling cycles, both temperature and time controlled	•	•	
management of blast chilling intensity with fan speed external regulator	•	•	
management of multipoint or multineedle probes	•	•	

MAIN FEATURES	AVAILABLE MODELS AND KIT PURCHASING CODES		OPTIONS
	Vcolor 819M/829M (5")	Vcolor 819L/829L (7")	multi-functional module EVC20P52N9XXX10
Other features			
management of special cycles (fish sanitation, thawing and ice cream hardening)	•	•	
management of retarding-proofing and slow cooking special cycles.	•	•	
recording HACCP data and graphics processing in real time	•	•	
ready-to-use OEM recipes and storage of user recipes	•	•	

- (1) configurable as alarm or needle probe heater
- (2) configurable as pump down valve or alarm
- (3) configurable as cabinet light, UV lamp, needle probe heater or alarm.

The series includes the following purchasing codes:

Vcolor 819M (5"):

- EVCMC819P9E: vertical format, flush installation
- EVCMC819P9EF: vertical format, semi-recessed installation

Vcolor 819L (7")

- EVCLC819P9E: vertical format, flush installation
- EVCLC819P9EF: vertical format, semi-recessed installation

Vcolor 829M (5"):

- EVCMC829P9E: horizontal format, flush installation
- EVCMC829P9EF: horizontal format, semi-recessed installation

Vcolor 829L (7")

- EVCLC829P9E: horizontal format, flush installation
- EVCLC829P9EF: horizontal format, semi-recessed installation

The purchasing code for EVlink Wi-Fi module is EVIF25SWX.

2 DESCRIPTION

2.1 User interface description

The diagram below shows the front view of the user interface in the vertical format

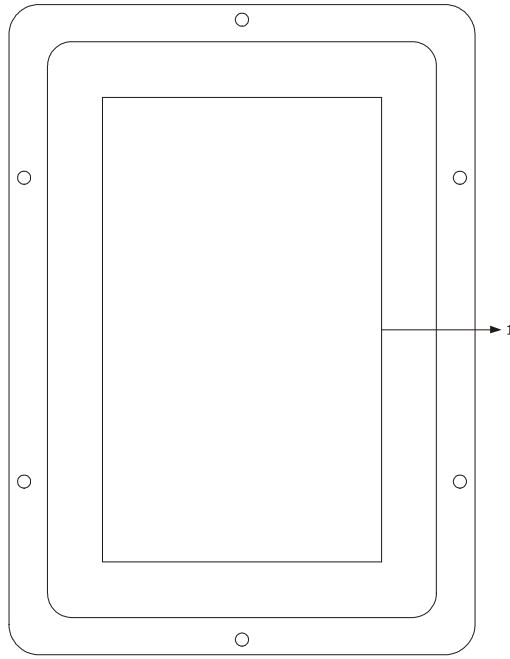

The diagram below shows the front view of the user interface in the horizontal format.

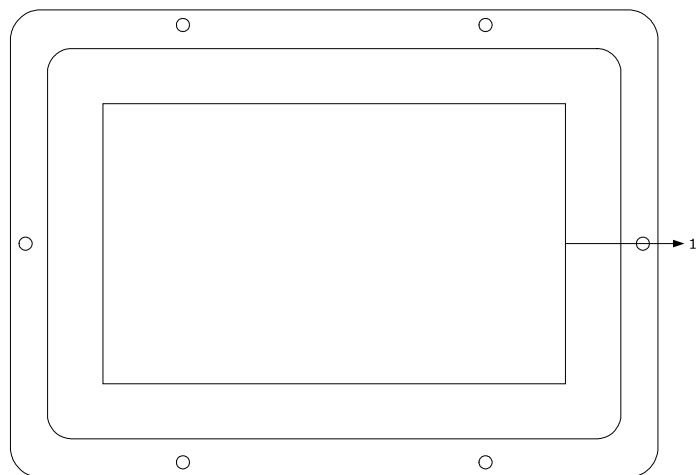

PART	DESCRIPTION
1	display

The diagram below shows the intended use of the user interface connectors.

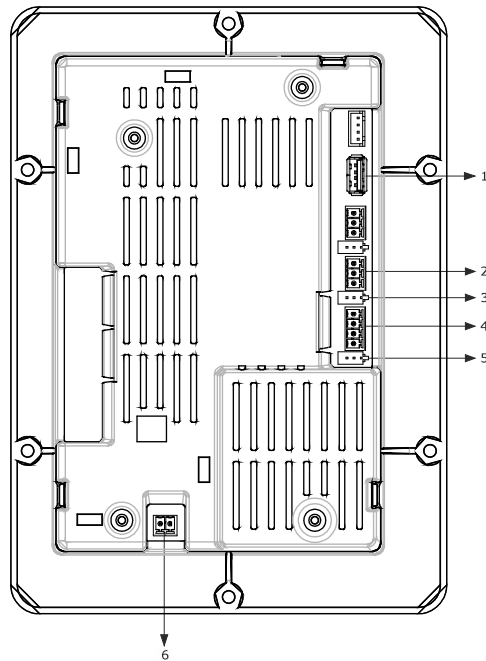

PART	DESCRIPTION
1	USB port
2	RS-485 MODBUS port
3	dip switch for the termination resistor for the RS-485 MODBUS port
4	power supply for the user interface and connection between the user interface and the control module
5	dip switch for the resistor connecting the user interface and the control module
6	appliance earthing

For more information see subsequent sections.

2.2 Control module description

The diagram below shows the intended use of the control module connectors.

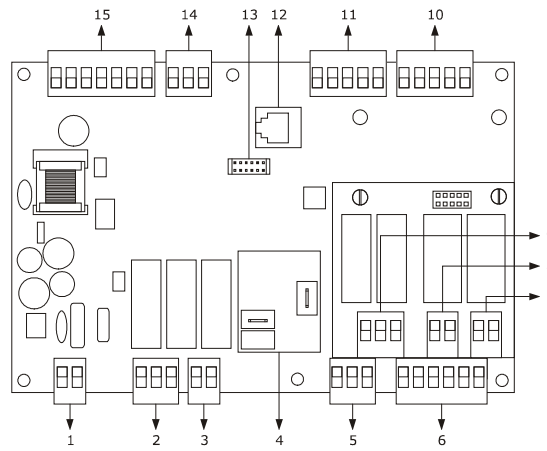

PART	DESCRIPTION
1	control module power supply
2	evaporator fan and condenser fan relay
3	defrost relay
4	compressor relay
5	door heater relay
6	door switch, compressor thermal switch, low pressure switch and high pressure switch
7	thawing heater relay
8	auxiliary relay 1 (see parameter u3)
9	auxiliary relays 2 and 3 (see parameters u1 and u2)
10	cabinet, evaporator and condenser probe
11	needle probe up to 3 sensors
12	unused
13	unused
14	output for phase cutting speed regulator for EVDFAN1 single-phase fans
15	user interface – control module connection

For more information see subsequent sections.

3 MEASUREMENTS AND INSTALLATION

3.1 User interface measurements

The picture below shows the measurements of the 5-inch user interface in horizontal format; measurements are expressed in mm (inches).

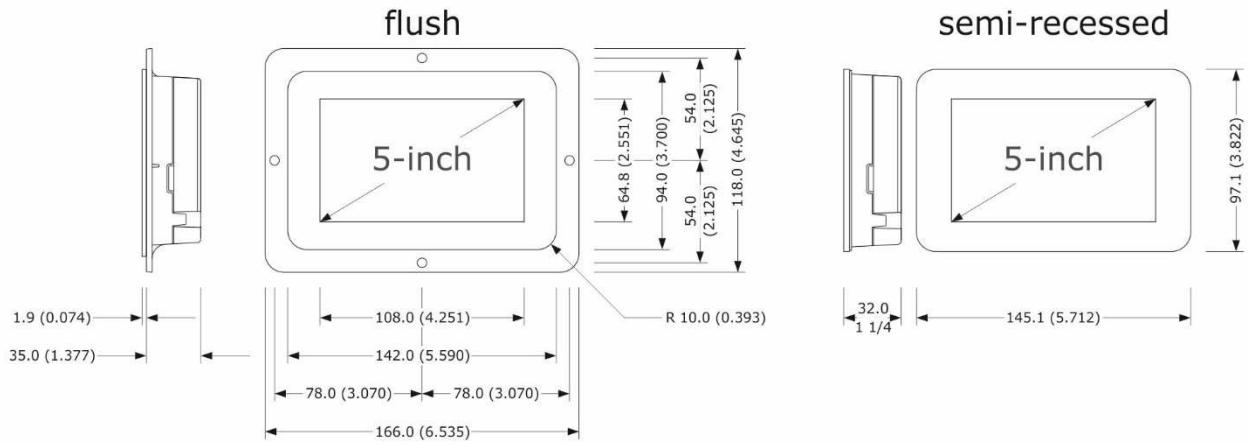

3.2 User interface measurements

The picture below shows the measurements of the 7-inch user interface in horizontal format; measurements are expressed in mm (inches).

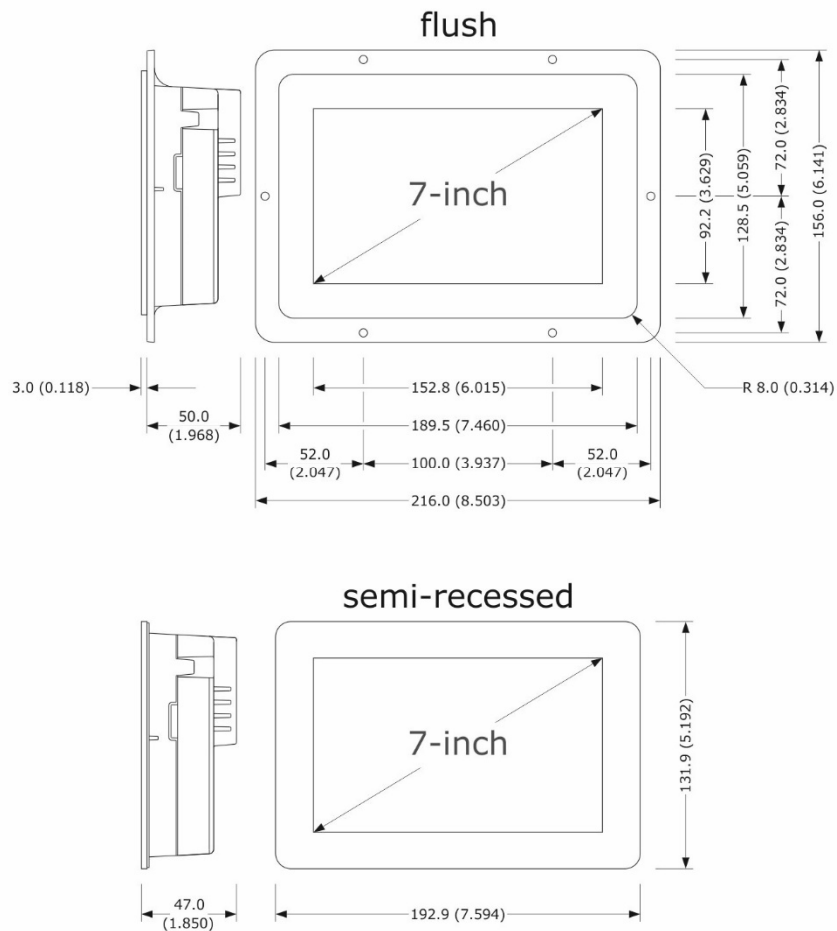

3.3 Control module measurements

The picture below shows the measurements of the **Vcolor 819** control module; measurements are expressed in mm (inches).

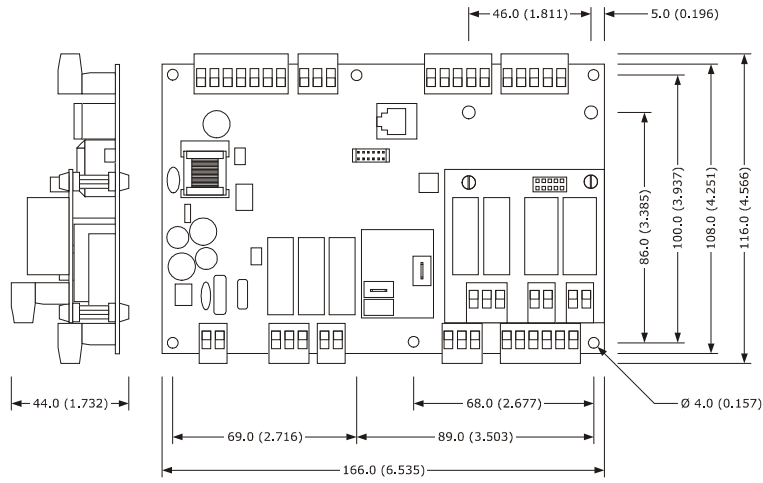

3.4 Multi-functional module measurements

The picture below shows the measurements of the **Vcolor 819** multi-functional module; measurements are expressed in mm (inches).

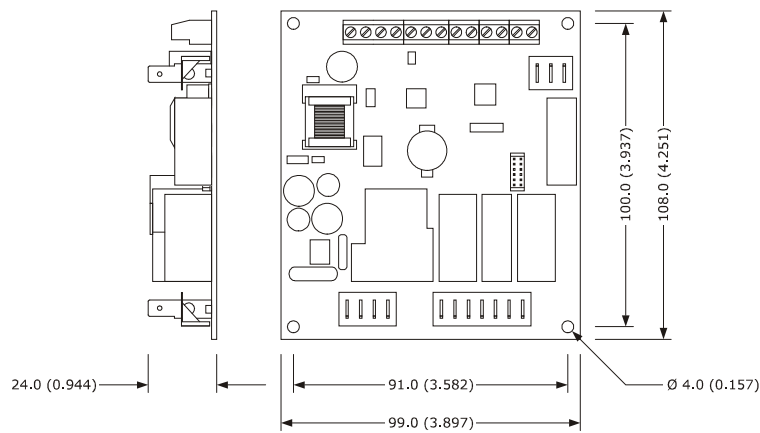

3.5 User interface installation

The figure below shows the installation of the user interface.

Depending on the model, installation can be:

- flush, from behind the panel with threaded studs (not provided) welded to hold it in place;
- semi-recessed, from the front of the panel with spring clips to hold it in place.

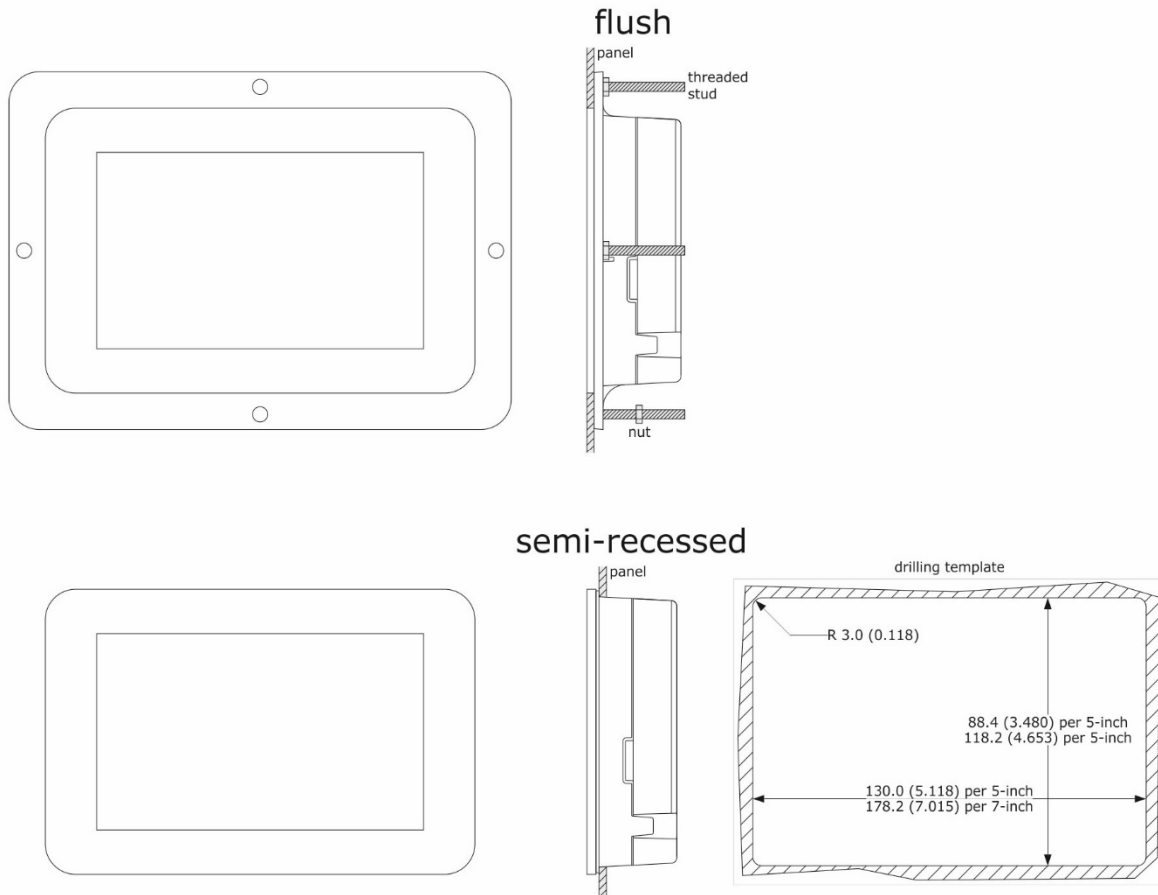

3.6 Control and multi-functional module installation

On a flat surface with spacers.

3.7 Installation precautions

- Ensure that the working conditions for the device (operating temperature, humidity, etc.) are within the set limits. See section 16 TECHNICAL SPECIFICATIONS.
- Do not install the device close to heat sources (heaters, hot air ducts, etc.), equipment with a strong magnetic field (large diffusers, etc.), in places subject to direct sunlight, rain, damp, excessive dust, mechanical vibrations or shocks.
- Any metal items close to the control module must be at a sufficient distance so as not to compromise the safety distance; any cabling must be placed at least 2 cm away.
- In compliance with safety regulations, the device must be installed properly to ensure adequate protection from contact with electrical parts. All protective parts must be fixed in such a way as to need the aid of a tool to remove them.

4 ELECTRICAL CONNECTION

4.1 Electrical connection of Vcolor 819M

The picture below shows the electrical connection of the controller with 5-inch display.

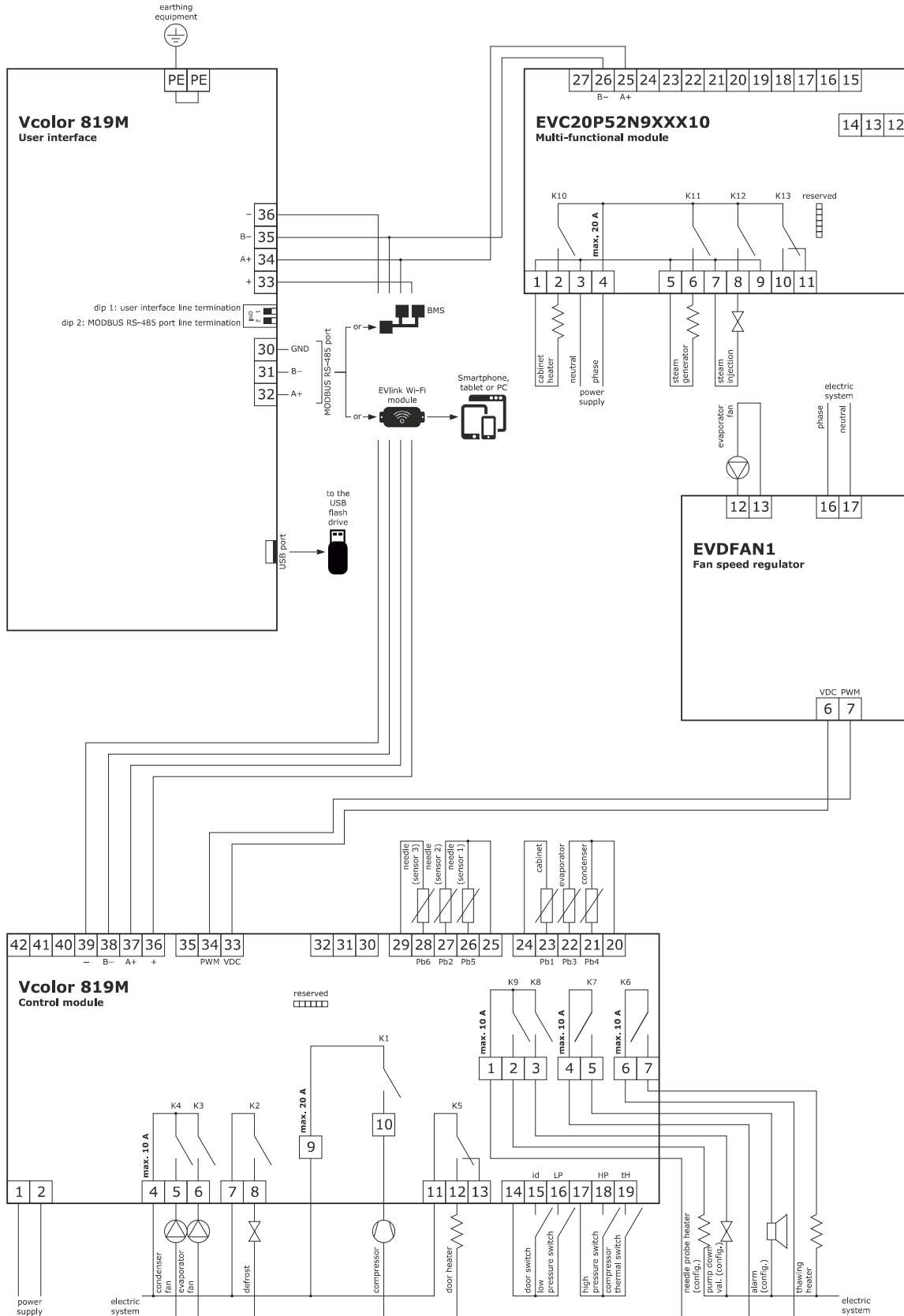

Detail electrical connection EVlink Wi-Fi

Vcolor 819M
User interface

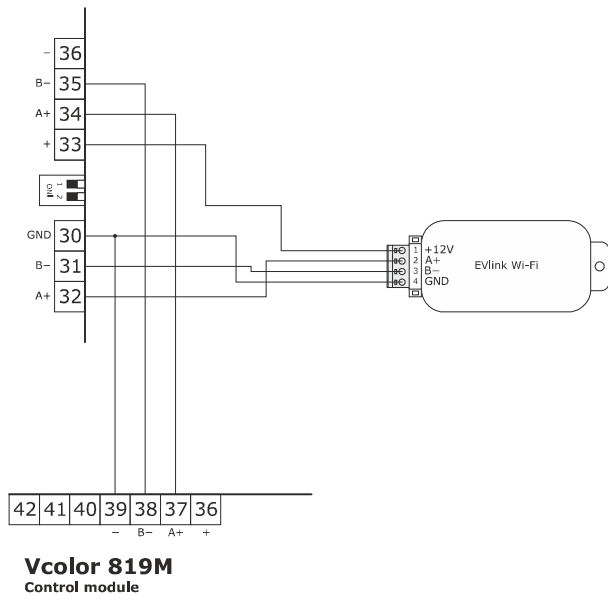

4.2 Electrical connection of Vcolor 819L

The picture below shows the electrical connection of the controller with 7-inch display.

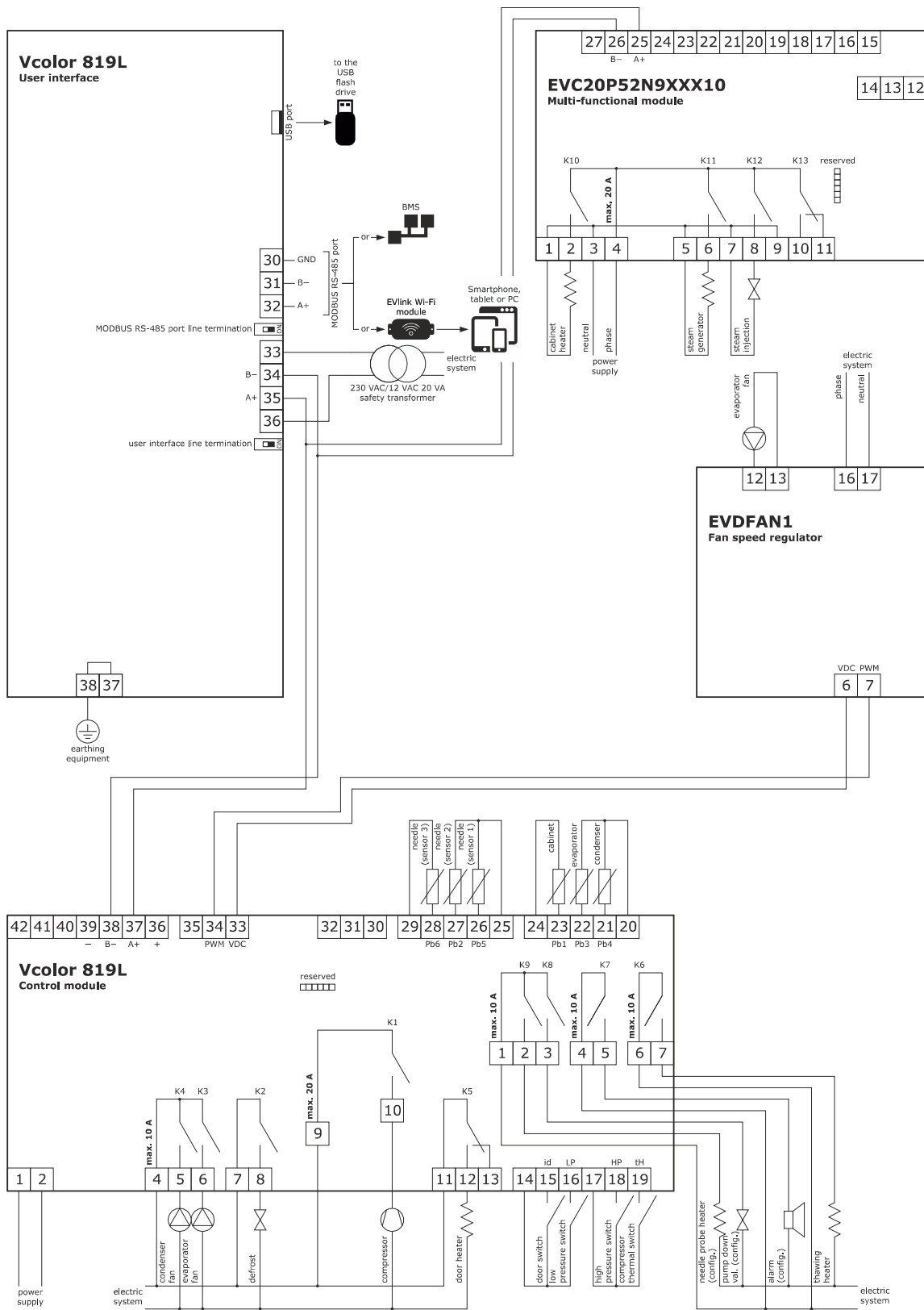

Detail electrical connection EVlink Wi-Fi

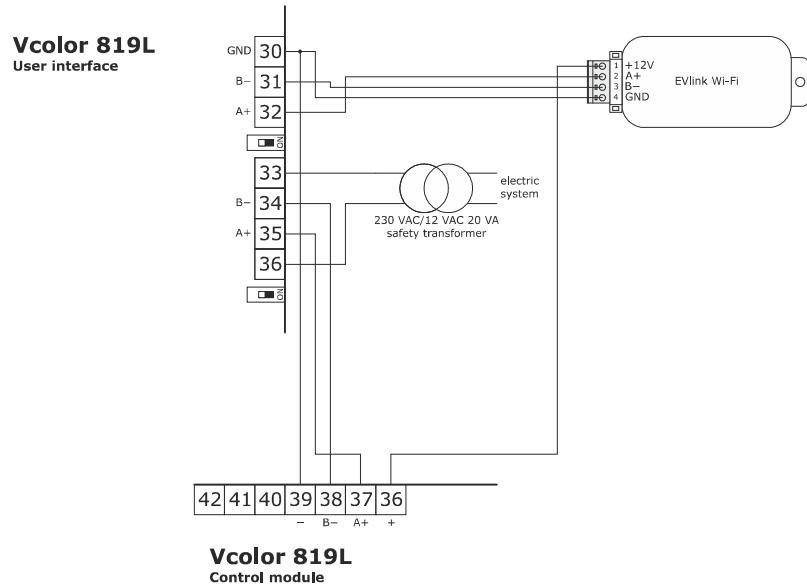

4.3 Precautions for electrical connection

- Do not use electric or pneumatic screwdrivers on the terminal blocks of the device.
- If the device has been moved from a cold to a warm place, the humidity may cause condensation to form inside. Wait about an hour before switching on the power.
- Make sure that the supply voltage, electrical frequency and power of the device correspond to the local power supply. See section 17 TECHNICAL SPECIFICATIONS.
- Disconnect the device from the power supply before doing any type of maintenance.
- Do not use the device as safety device.
- For repairs and for further information on the device, contact the EVCO sales network.



5 USER INTERFACE

5.1 Initial information

The interface has the following operating modes:

- "off" (no power to the device);
- "stand-by" (the device is powered but switched off);
- "on" (the device is powered, switched on and awaiting start-up of an operating cycle);
- "run" (the device is powered, switched on and running an operating cycle).

Terminology: "switch on the device" means moving from "stand-by" to "on" mode and "switch off the device" means moving from "on" to "stand-by" mode.

If the power supply fails during "stand-by" or "on" mode, when power is restored the device will return to the mode set before the failure.

If the power supply fails during "run" mode, when power is restored the device will operate as follows:

- if blast chilling or blast-freezing was in progress, the cycle will resume, taking into account the duration of the power loss;
- if a conservation cycle was running, this will continue using the same settings;
- if a proofing or slow cooking cycle was running, the cycle will continue where it left off.

5.2 Initial switch-on

Connect the power supply to the device: if parameter E9 is set at 1, the device will show the EVCO splash screen for 10 seconds; if the parameter is set at 0, a system loading screen will be shown:

E9=1



E9=0

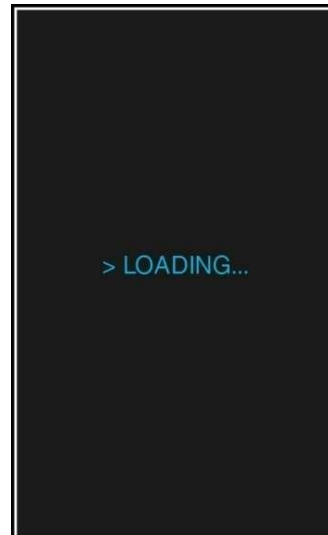

Once loading is complete, the device will display the mode it was in before being powered down:

- On/Stand-by screen, press the central area to move to the Home screen;
- directly the Home screen.

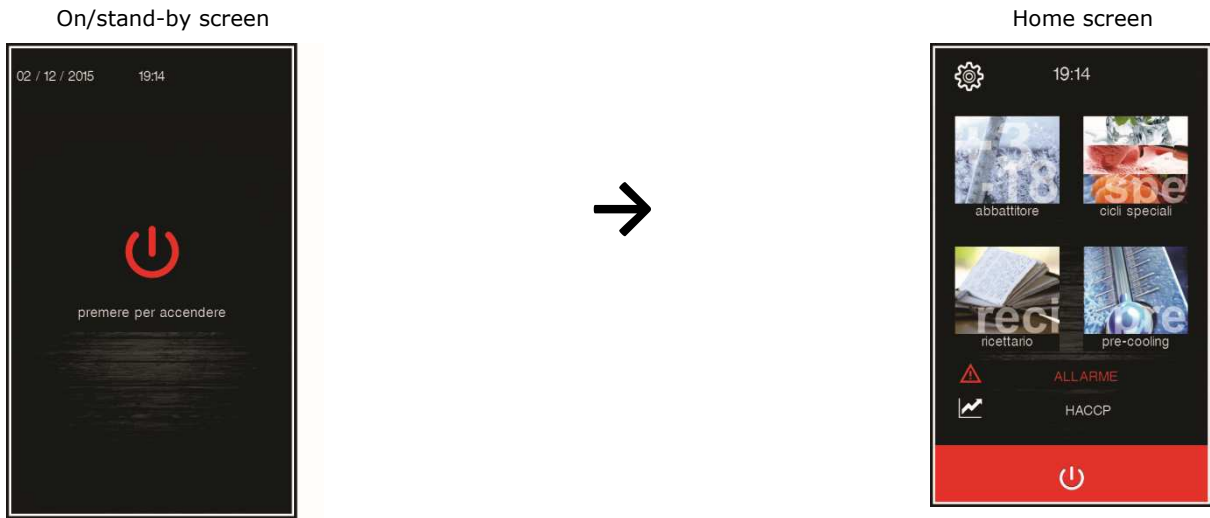

Δ If the power supply has been cut off long enough to cause a clock error (**RTC** code), it will be necessary to reset the date and time. The date and time can be set from the settings screen, service section (paragraph 12.1).

5.3 Switching the device on and off



To switch the device on, press the central area in the On/Stand-by screen and the Home screen will open.



To switch the device off, press the red area at the bottom of the Home screen.

5.4 Lock/unlock keypad

The keypad can be locked by setting parameter E7 to 1, locking the keypad after the period of inactivity set by parameter E8.

If the keypad is locked, a pop-up will appear when it is touched indicating that it is locked and how to unlock it. It can be unlocked by dragging a finger to the right.

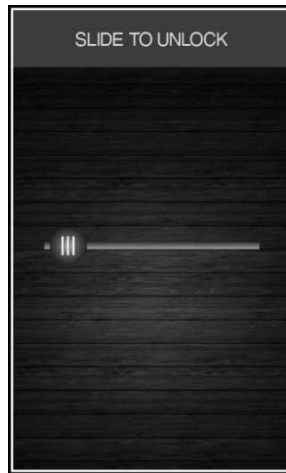

5.5 Silencing the buzzer

Press any key while the buzzer is sounding.

5.6 Door-open signal

When the door is opened the signal shown below will appear on the display.

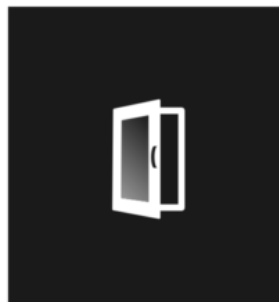

Press any area on the display to remove this signal.

6 FUNCTION MODES

6.1 Initial information on operating cycles

The device is capable of operating in the following modes:

- temperature controlled blast chilling and conservation
- hard temperature controlled blast chilling and conservation
- time controlled blast chilling and conservation
- hard time controlled blast chilling and conservation
- temperature controlled blast-freezing and conservation
- soft temperature controlled blast-freezing and conservation
- time controlled blast-freezing and conservation
- soft time controlled blast-freezing and conservation
- multineedle probe continuous cycle
- multi-timer continuous cycle
- pre-cooling
- proofing
- slow cooking

The following functions are also available:

- fish sanitation
- thawing
- defrosting
- ice cream hardening
- sterilisation
- heating the needle probe
- drying

For more information see the subsequent sections.

6.2 Initial information on the needle probe

This device is capable of managing multipoint needle probes (with up to three sensors) or multineedle probes (up to three probes).

To set the type of probe to be used, configure parameter P3:

- P3=0 no needle probe;
- P3=1 a single needle probe;
- P3=2 multineedle probe (multiple independent needle probes);
- P3=3 multipoint needle probe (multiple sensors in the same probe).

Once the type of probe has been set, parameter P9 sets:

- the number of probes, when P3=2 (multiprobe);
- the number of sensors, when P3=3 (multipoint).

If a multipoint probe is to be used for running temperature controlled blast chilling, blast-freezing and sanitation cycles, the hottest sensor will be used as the reference point. For slow cooking cycles and for heating the probe, the coldest sensor will be used.

6.3 Selecting the operating mode

All the operating functions can be accessed from the Home screen by selecting the desired area.



Enables the blast chilling mode in which it is possible to select/set a standard blast chilling/blast-freezing cycle, a multineedle probe or multi-timer cycle, see chapter 7.



Enables special cycles in which it is possible to select one of the special cycles available according to the configuration of the machine, see chapter 8.



Enables recipe mode to be selected, with recipes saved in the memory, see chapter 9.



Makes it possible to select a cabinet pre-cooling cycle, see chapter 10.



This area is displayed if an alarm is in progress.



Pressing this area enables the historical data stored during operation to be seen. See sections 7.6.2 and 12.1.

7 BLAST-CHILLING MODE



Press on this area to open the screen shown below.



Now one of the areas shown can be selected: blast chilling, blast-freezing, continuous cycle and customized cycle, details below.



Enables selection of a standard blast chilling cycle, uploading the relevant pre-settings. On the same screen it is possible to select hard mode when blast chilling consists of two phases with different set points. When blast chilling is complete the corresponding conservation phase is run, with the set points established by the blast chilling mode selected. See sections 7.1 and 7.2.



Enables selection of a standard blast-freezing cycle, uploading the relevant pre-settings. On the same screen it is possible to select soft mode when blast-freezing consists of two phases with different set points. When blast-freezing is complete the corresponding conservation phase is run, with the set points established for the blast-freezing mode selected. See sections 7.1 and 7.2.



Enables selection of a continuous blast chilling/blast-freezing cycle, where it is possible to set multiple operating timers. For more detail see section 7.3.



Press on this area to start up the procedure for setting a customized cycle. This cycle makes it possible to set up to four phases. Once the phases are set they can be started up or the program set can be saved in the recipe book. See section 7.4



This area is displayed if an alarm is in progress.

7.1 Blast chilling/blast-freezing and conservation



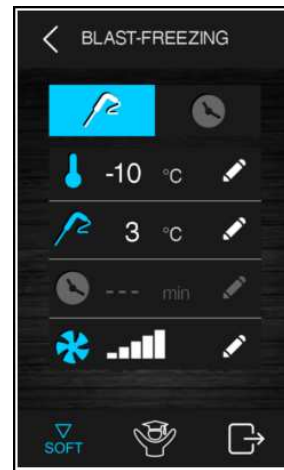
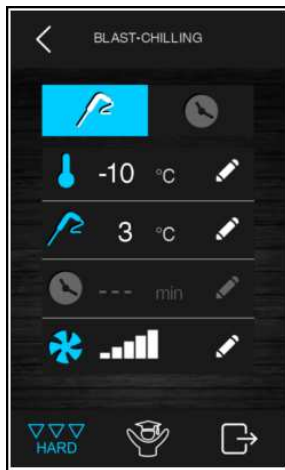

Pressing on one of these areas enables a blast chilling or blast-freezing cycle to be set. The following screen opens and the key lights up blue. If the needle probe is being used and there is no error, the cycle always defaults to temperature control. To move to a time controlled cycle, press area which will switch off the needle probe area and the time controlled area will light up blue.



The cycle selected will use the preloaded settings for that cycle, but pressing area makes it possible to change the main settings, within the permitted range, which are shown on the display. To change all the various set points for the phases of the selected cycle, expert mode can be enabled by pressing area . Once all the settings have been done, press area to terminate the phase. The screen summarising all the setting data for the cycle will appear, as shown below.



Press area  to save the program just set, or press area  to start up the cycle.

If it is a temperature controlled cycle, a test will be performed to check that the needle probe has been correctly inserted in the food item to be blast chilled. If the test fails, the cycle automatically switches to time control, the buzzer sounds and the alarm in progress signal appears on the display. For more details about how to run the test, see section 7.6.1.

While the cycle is in progress, the display will show the main set points and a graphic charting the temperature. The cycle can be stopped at any time by pressing the  key.

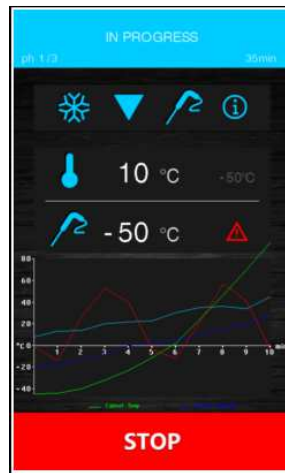



On completion of the blast chilling/blast-freezing cycle, when the needle probe has reached the right temperature or the time period is finished, the buzzer sounds and the conservation phase begins. The graphic charting the temperature will not be available if the cycle has restarted following a power failure.



The conservation phase is not timed and is only terminated when the  key is pressed.

7.2 Hard blast chilling/soft blast-freezing and conservation

It is possible to select a hard blast chilling/soft blast-freezing cycle on the blast chilling/blast-freezing settings screen by pressing area  or . Before selecting this mode, make sure the type of cycle (temperature or time controlled) has been set.

This cycle consists of two blast chilling phases at different set points, followed by a conservation phase.

- The first phase, known as hard for blast chilling and soft for blast-freezing, has set points established by the relevant parameters and these cannot be modified;
- The set points for the second blast chilling/blast-freezing phase can be modified;
- The set points for the third conservation phase can be modified.

Once the phase is complete, the controller moves on automatically to the next one. The end of the first two phases is signalled by the buzzer sounding.

It is also possible to select the time controlled mode for this cycle, in which case the controller moves on to the next phase when the set time has elapsed.

7.3 Continuous cycle



Pressing on this area enables selection of a continuous cycle and it can be run in multineedle probe mode if a temperature controlled cycle has been selected, or in multi-timer mode if a time controlled cycle has been selected. If only a single needle probe has been selected, only the multi-timer mode can be used.

Once the cycle has been selected, a screen opens up on which the cabinet temperature values and fan speed can be set, as well as the product temperature values (in the multineedle probe cycle).



Continuous cycle - needle probe

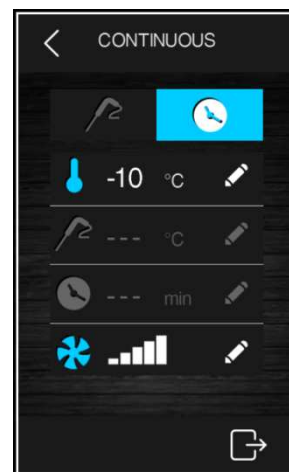

Continuous cycle - time control

Press the  key to start up the cycle and this will only finish when all the needle probes have reached the set temperature or all the timers have elapsed, after which the controller moves on automatically to the conservation phase.

7.3.1 Multineedle probe mode

The continuous cycle using multineedle probes can be run provided the parameter for the type of needle probe has been correctly set (P3=2). The controller can manage up to three needle probes, using parameter P9 to set these up. While the cycle is in progress, each time the door is opened and closed the controller checks that the various needle probes have been properly inserted and the cycle is only terminated when all the probes inserted have reached the desired temperature.

When each needle probe has reached the set temperature, the buzzer sounds and the display indicates this, showing the temperature of the probe in question in green. The diagram below shows an example of the display when only one probe has reached the set temperature.



7.3.2 Multi-timer mode

The time controlled cycle makes it possible to set up to four timers.

The cycle starts up activating only the first timer with its pre-set values. The other timers and their pre-set values can be enabled by pressing the pencil icon and setting a time once the cycle is underway.

When the time period is set and the timer setting confirmed, the timer count starts up immediately. Each timer operates independently and on completion of the period it can be reset, starting the timer count up again.

The cycle only terminates when all the set timers have elapsed. When the timer count is complete the buzzer sounds and the display shows in green the value "0 min" for the relevant timer.

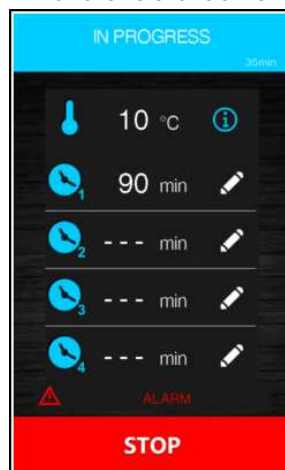



7.4 Customized cycle

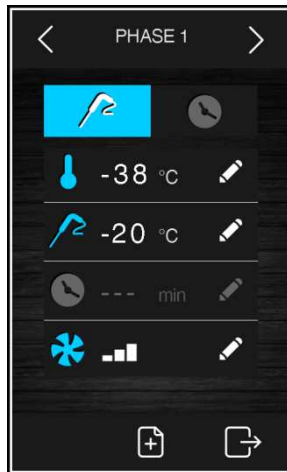

The customized mode makes it possible to set up a cycle consisting of a maximum of 4 phases (3 blast chilling and 1 conservation) and these can be temperature or time controlled or a mixture of both.



The customized cycle starts up and activates the first phase, which by default is a needle probe phase. It is possible to change the probe phase to a time controlled phase and to set the relative set points.

To add any more phases press area , while to eliminate any phase previously set in the program, press area . It is possible to move between the various phases using the arrows at the top of the screen.

Once the desired phases have been selected and set up, press area  to confirm that the settings are complete and a summary screen will be displayed.



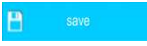



Press area  to start up the cycle or area  to save it in the recipe book.

7.5 Setting the set points

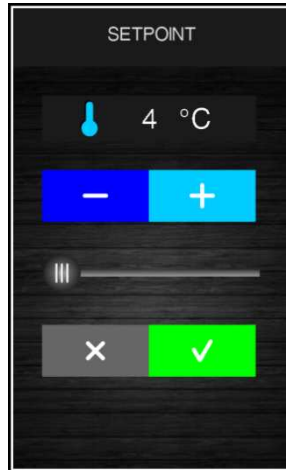
7.5.1 Setting the cabinet temperature set point

When selecting a continuous or customized blast chilling or blast-freezing cycle, the pre-set cabinet temperature, product temperature, time and fan speed values when the parameters were set are loaded. These can be modified by the user within the permitted range for the parameters. To make a modification press the  key and the screen shown below will appear.

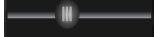

Set the desired value using the   key or the  key. Once set-up is complete press the  key to confirm the value and return to the previous screen, or press the  key to reload the pre-set values and return to the previous screen.

7.5.2 Setting the product temperature set point

Proceed as described for the cabinet set point, after pressing area  for the product temperature (or the temperature indicated by the needle probe).



7.5.3 Setting the cycle duration

Proceed as described for the cabinet set point, after pressing area  for the cycle duration.

7.5.4 Setting the fan speed

To modify this, press area  for the fan speed and the screen shown below will open.



Set the desired value pressing the  key. Once set-up is complete press the  key to confirm the value and return to the previous screen, or press the  key to reload the pre-set values and return to the previous screen.

The minimum fan speed value that can be set for all cycles (except for slow cooking) is given by parameter F53.

The minimum fan speed value that can be set for slow cooking is given by parameter F54.

7.6 Running the cycle

Pressing the  key starts up the cycle as it has been set. If it is a temperature controlled cycle, the blast chilling/blast-freezing phases terminate when the needle probe, or probes, reach the set temperature. If it is a time controlled cycle, the blast chilling/blast-freezing phases terminate when the set time period, or periods, have elapsed. While the cycle is in progress the screen below will be shown.

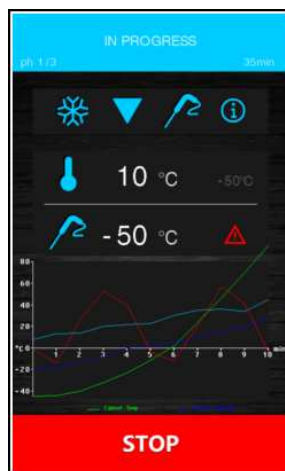

The screen shows a summary of the features of the cycle in progress and a chart with the various values required (cabinet temperature and product temperature for temperature controlled cycles and cabinet temperature and time period for time controlled cycles).

Press area  to see the probe values, input and output status and any alarms underway.

Press area  ALARM, which is only active when an alarm is underway, to see the type of alarm in progress.

7.6.1 Needle probe insertion test

If the needle probe is enabled or if parameter P3 is set to a value other than 0, temperature controlled cycles are preceded by a two-phase test to check that the needle probe is correctly inserted. If the needle probe is not enabled or if parameter P3 is set at 0, only time controlled cycles can be selected.

The test consists of two phases, the second only carried out if the first was not successfully completed. Phase one is successfully completed if the gap between the "temperature detected by the needle probe" and the "cabinet temperature" is greater than the value set by parameter r17 in at least three out of five checks, these checks being performed at ten-second intervals. The second phase is successfully completed if the gap between the "temperature detected by the needle probe" and the "cabinet temperature" is greater than 1°C/1°F, as compared to the check previously carried out, in at least six out of eight checks, these checks being performed at intervals corresponding to 1/8 of the time set by parameter r18.

If a multineedle probe is being used, the test is performed for each probe.

If a multipoint probe is being used, when the test is concluded with a positive result for at least one of the sensors, the device will function as follows.

- The sensor showing the lowest temperature is then used as the point of reference for heating the needle probe.
- The sensor showing the highest temperature is then used as the reference point for the end of the temperature controlled cycles.
- Any sensors for which the test is not completed with a successful outcome are not subsequently used.

If the test fails to record a positive outcome, or if the needle probe is not inserted, the buzzer sounds and the cycle automatically changes to time-controlled.

7.6.2 Recording historical data

While a cycle is in progress records are kept of the temperature values of any probes enabled, output activations, input status, defrosting cycles carried out and any alarms.

The type of data to be recorded can be set using the menu accessible from the service area, see section 12.1.

These data are available for subsequent download to a USB device, see section 13.4.

7.6.3 Cycle end

If the temperature controlled blast chilling/blast-freezing cycle is successfully completed, in which the centre of the product reaches the required temperature in the allotted time, the device moves on automatically to the conservation phase, with the following screen appearing.

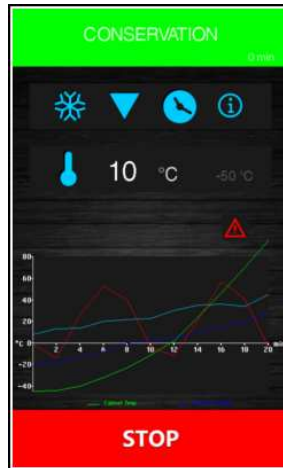

If the temperature controlled cycle is not completed in the allotted time, this problem will be signalled by the appearance of the alarm icon, but the blast chilling cycle will still continue.

In temperature controlled cycles, pressing the  key will bring up the screen granting access to the following functions.

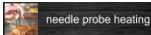

heat needle probe to remove it from the product;

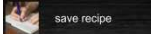

record the cycle just performed in the memory.

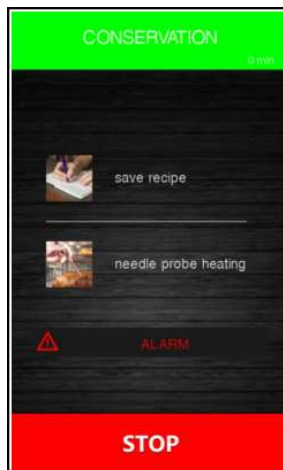

At the end of a time controlled cycle, the initial screen for the blast chilling/blast-freezing modes will appear.



8 SPECIAL CYCLES MODE



Press this area on the Home page to open the screen shown below.



This screen grants access to further functions, some always present, others that can be activated by setting the parameter. If the function is not available, the area relating to that function and enabling it to be selected will not be shown.

N.B. If both the sterilisation and the needle probe heating cycles are enabled, two alternatives will appear on the special cycles page, according to the temperature indicated by the needle probe: if this temperature is below -1°C , an icon will appear to select the needle probe heating option, if it is above 0°C , the sterilisation icon will appear.

The functions available are listed below



Pressing this area enables selection of a fish sanitation cycle (a function always shown); see section 8.1.



Pressing this area enables selection of a thawing cycle (a function always shown); see section 8.2.



Pressing this area enables selection of a manual defrost cycle (a function always shown); see section 8.3.



Pressing this area enables selection of an ice cream hardening cycle (a function always shown); see section 8.4.



Pressing this area enables selection of a sterilisation cycle (a function activated by parameter); see section 8.5.



Pressing this area enables selection of a needle probe heating cycle (a function activated by parameter if at least one needle probe is being used); see section 8.6.



Pressing this area enables selection of a drying cycle (a function activated with the door closed); see section 8.7.



Pressing this area enables selection of a proofing cycle (a function activated by parameter); see section 8.8.



Pressing this area enables selection of a slow cooking cycle (a function activated by parameter); see section 8.9.

The last two functions (proofing and slow cooking cycles) can only be activated jointly by E12 parameter, both of which will be shown if they are present.

8.1 Fish sanitation



Pressing this area enables selection of a fish sanitation cycle.

This special cycle consists of the following phases:

- blast chilling with the cabinet set point set by parameter r19 and with the product temperature set point set by parameter r20;
- holding for the time period set by parameter r21 and the cabinet set point given by r20;
- conservation with the cabinet set point given by r22.

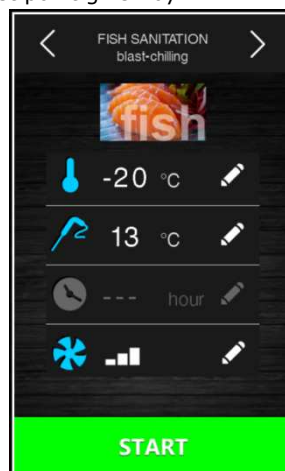

The arrows at the top make it possible to move between the various sanitation phases to see/modify the set points.

After the function is selected, the screen with the pre-settings will be shown, that can be modified.

Pressing the  key starts up the sanitation.

While a sanitation cycle is in progress the device will show the temperature to end blast chilling, the working set point during blast chilling and the duration of the holding phase.

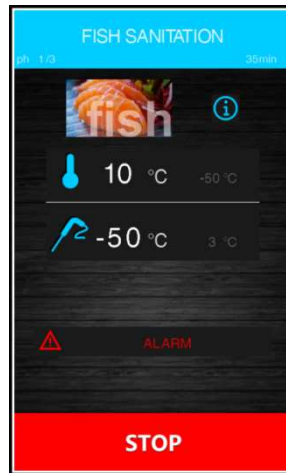

The sanitation cycle starts with the blast chilling phase. When the temperature recorded by the needle probe reaches the temperature to end blast chilling, the device will move on automatically to holding.

The temperature to end blast chilling (set by r20) is also the working set point during holding.

When the holding period has elapsed, the device will move on automatically to conservation.

The probe insertion test is always carried out at the beginning of the cycle: if the test is not completed, the buzzer sounds and the cycle is interrupted.

During blast chilling the device shows the temperature recorded by the needle probe, the cabinet temperature and the time elapsed since the start of the blast chilling process.

The cycle may be interrupted early by pressing the  key.

8.2 Thawing



Pressing this area enables selection of a thawing cycle, managed according to the load of product to be thawed, in compliance with the maximum quantity stated by the manufacturer.

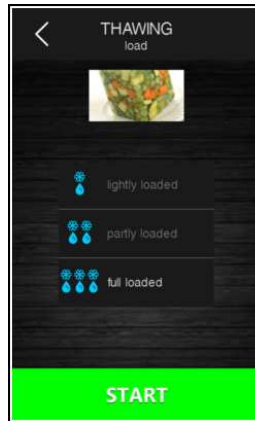

To make it easy, the quantity of product to be selected is divided into three load bands for each of which the controller will load three different sets of parameters, according to the following framework.

Load band	Initial cabinet set point	Final cabinet set point	Cycle duration
Light load	r25	r28	r32
Medium load	r26	r29	r33
Heavy load	r27	r30	r34

These three parameters will be used to control the working cabinet set points and the duration of the thawing cycle, equally divided into five phases following on from each other as shown.

- Phase 1 working set point = initial set point
- Phase 2 working set point = phase 1 set point - [(initial set point – final set point) / 4]
- Phase 3 working set point = phase 2 set point - [(initial set point – final set point) / 4]
- Phase 4 working set point = phase 3 set point - [(initial set point – final set point) / 4]
- Phase 5 working set point = final set point

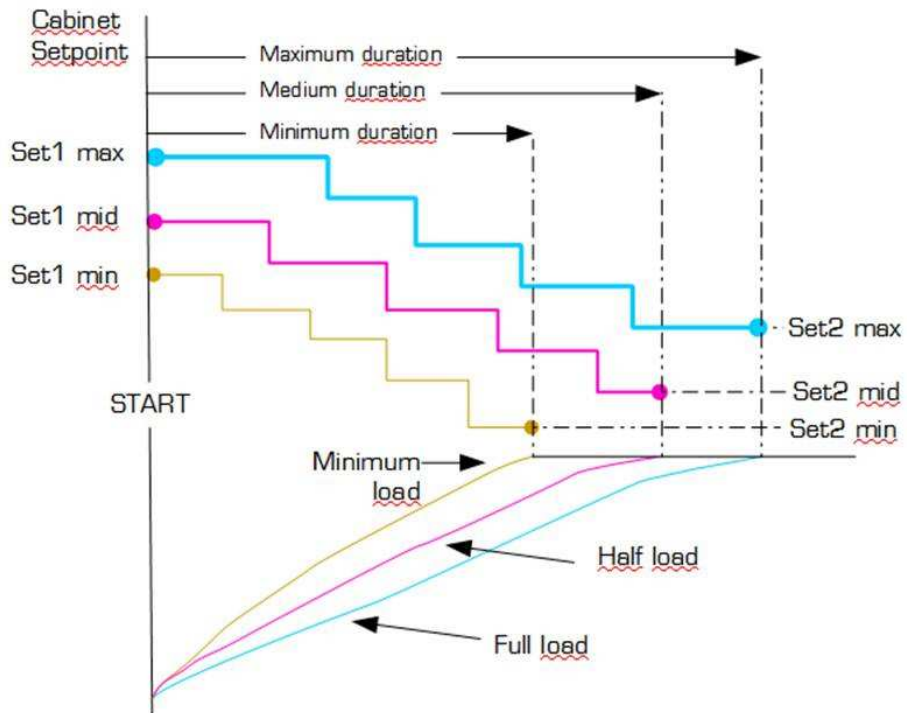

Five parameters are used to manage the ventilation, one for each phase, setting the fan speed independently of the load. These parameters are: F29, F30, F31, F32, F33.

At the end of the thawing cycle the buzzer sounds, after which the machine moves on to a conservation phase, its set point set by parameter r31 for an indefinite period. The fans will work at the speed set by parameter F34.

It is not possible to run defrosting cycles during thawing, while during the conservation phase an automatic defrost can be run at intervals set by parameter.

If the door is opened, the heater will be stopped no matter what the parameter value is. The screen shot below shows a thawing cycle in progress.

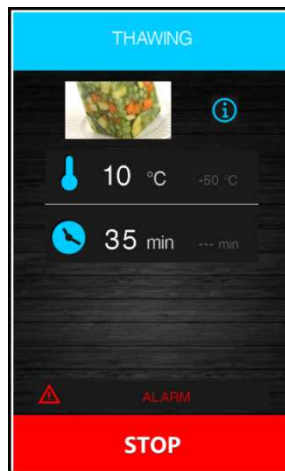

8.3 Defrosting



Pressing this area enables selection of a manual defrosting cycle, which is started up by pressing area . When the cycle starts up the following page is displayed.

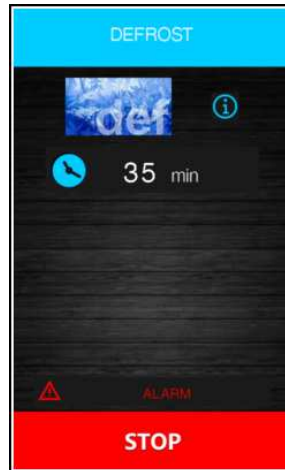

Defrosting can also be done automatically at time intervals set by parameter d0, provided this value is not set at 0. Regardless of how have been started up, defrosting cycles are managed by the following parameters.

- d0 Interval between two consecutive defrosts
- d1 Type of defrost
- d2 Evaporator temperature to end defrost (can be set if P4 is set to 1)
- d3 Defrost duration
- d4 Defrost start-up at the beginning of a blast chilling/blast-freezing cycle
- d5 Defrost start-up delay from the start of conservation after blast chilling/blast-freezing
- d7 Drip duration
- d15 Minimum compressor switch-on duration for starting hot gas defrost
- d16 Pre-drip duration (can be set if hot gas defrost is selected)

The type of defrost can be selected by parameter d1. There are four ways of performing a defrost cycle.

- d1=0 Electric defrost
- d1=1 Hot gas defrost
- d1=2 Air defrost
- d1=3 Air defrost with door open

An automatic defrost cycle is activated at the start of a blast chilling/blast-freezing cycle if d4=1. Regardless of the parameter d4 value, automatic defrost is activated with a delay as compared to the beginning of the conservation phase set by parameter d5.

If the evaporator probe is present when a defrost cycle is to be activated, this only starts if the temperature indicated by the evaporator probe is lower than the value of parameter d2.

Defrosting finishes when the evaporator temperature is above the value of parameter d2 or if the temperature has not been reached within the required time set by parameter d3.

8.4 Ice cream hardening



Pressing this area enables selection of an ice cream hardening cycle.

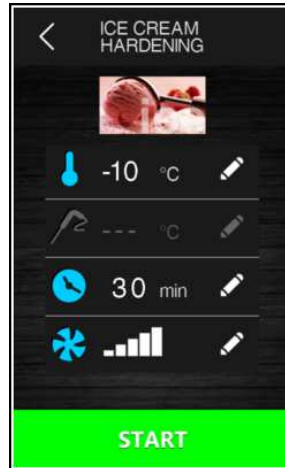

This is a time controlled blast-freezing cycle with the set point provided by parameter r8 and the duration by parameter r24. At the end of the time set by r24, there is no move to a conservation phase, the hardening cycle continues until the **STOP** key is pressed.

If the door is opened the time count stops and restarts when the door is closed.

8.5 Cabinet sterilisation



Pressing this area enables selection of a sterilisation cycle.



This function can be activated by parameter and can only be used if $u1=1$. If the needle probe heating function has also been enabled, the sterilisation icon is shown if the temperature recorded by the needle probe is above 0°C .

The cabinet door must be closed to start up a sterilisation cycle.

Pressing the **START** key starts up the sterilisation cycle. Sterilisation ends when the time set by parameter $u6$ has elapsed, after the **STOP** key has been pressed or if the door is opened.

During sterilisation the cabinet sterilisation relay is active. If parameter $u11$ is set to 1, the evaporator fans are also active. If the fans are run at variable speeds, there will be 100% ventilation during sterilisation.

The display will show the count-down for the remaining time. At the end of the cycle the buzzer sounds and the screen returns to the Home screen.

8.6 Heating the needle probe



Pressing this area enables selection of a needle probe, or probes, heating cycle.

This cycle can also be run automatically if the **STOP** key is pressed during conservation, following a blast chilling/defrosting cycle.



The function can be activated by parameter and can only be used if u1=2 or u3=1. If cabinet sterilisation has also been enabled, the needle probe heating icon is shown if the temperature recorded by the needle probe is above 0°C . The needle probe heating output is activated at maximum for the time set by parameter u8 or until the temperature indicated by the needle probe has reached that set by parameter u7. At the end of heating, the buzzer sounds. Heating can be stopped by pressing the **STOP** key.

8.7 Drying



Pressing this area enables selection of a drying cycle.



This is a cycle of forced-air ventilation that can be activated with the door closed and for a duration set by parameter u13. If the door is opened during drying this does not affect the cycle. The cycle stops when the prescribed time has elapsed or when the **STOP** key is pressed.

8.8 Proofing



Pressing this area enables selection of a proofing cycle. This function can only be enabled if an expansion has been set (parameter E12=1).

8.8.1 Description of proofing

The controller provides complete control for retarding-proofing cabinets for bread or pastry by managing the complete dough retarding-proofing cycle automatically.

A proofing cycle consists of four phases with different temperatures, relative humidity and time periods, one following on from the other, as in the sequence described below.

1 **Blast chilling phase**

The purpose of this is to block the leavening agents in freshly prepared dough placed in the machine to retard proofing.

2 **Re-awakening phase**

This “wakes up” the leavening agents in the dough by raising the temperature in the cabinet, thus producing a pre-proofing state.

3 **Proofing phase**

This completes the dough proofing process making it oven-ready.

4 **Conservation phase**

This keeps the risen dough in a waiting state before it is removed and placed in the oven for cooking. It lasts for an indefinite period and stops when the  key is pressed.

8.8.2 Setting up a proofing cycle

Having selected a proofing cycle, use the screen that appears to set the required values from within the prescribed range.

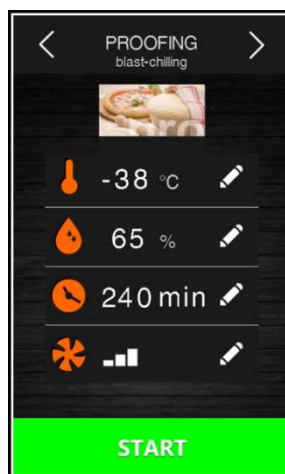

By default the controller always loads the pre-set values for the various phases as shown in the table below (these can be personalised via the manufacturer’s parameters). The settings for the cycle can be modified before it is started up

using the special menus and once the  key has been pressed, the proofing cycle starts up. It is not possible to modify the set points while the cycle is in progress.

If a phase is set at 0, it will not be run.

In the blast chilling phase the cabinet humidity control can be omitted using parameter rU4, but this must be set in the other phases.

The conservation phase may be omitted by setting the time to "---".

Blast chilling	Cabinet setting (rC3)	5°C
	Humidity setting (rU5, only if rU4=1)	---
	Duration setting (rH7)	120 min
	Ventilation setting (F42)	5
Re-awakening	Cabinet setting (rH3)	20°C
	Humidity setting (rU6)	60 %rH
	Duration setting (rH8)	240 min
	Ventilation setting (F43)	5
Proofing	Cabinet setting (rH4)	30°C
	Humidity setting (rU7)	80 %rH
	Duration setting (rH9)	180 min
	Ventilation (F44)	5
Conservation	Cabinet setting (rH5)	25°C
	Humidity setting (rU8)	80 %rH
	Enable phase	Yes (inf)
	Ventilation setting (F45)	5

8.9 Slow cooking



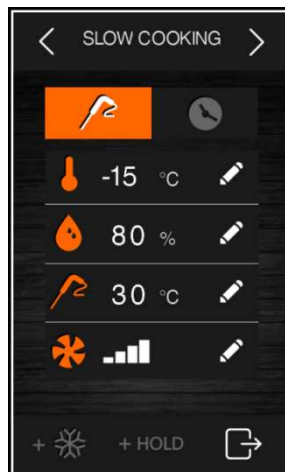

Pressing this area enables selection of a slow cooking cycle. This function can only be enabled if an expansion has been set (parameter E12 = 1).

After selection of the slow cooking function, a screen will appear on which it is possible to view and modify the relevant set points and to decide whether to set up a temperature or time controlled process. It is not possible to modify the set points while the cycle is in progress.



The slow cooking pre-settings use the following parameters:

- rH10 cabinet set point
- rH11 product temperature set point
- rH12 cycle duration
- rU9 % humidity
- F40 fan speed

Two areas at the bottom of the screen make it possible to add a subsequent blast chilling/blast-freezing phase  and a product holding/conservation phase .

For blast chilling or blast-freezing, the pre-settings are those for the cycle, whereas the following parameters are used to set up a holding or conservation phase:

- rH13 cabinet set point for holding phase
- rU10 % humidity in holding
- F41 fan speed

If a holding phase has been enabled following a slow cooking cycle, this will be activated at the set temperature and humidity and it will have an indefinite duration. If blast chilling or blast-freezing has been enabled, this will be performed according to the procedures for the cycle in question (blast chilling/blast-freezing and moving on automatically to conservation).

9 RECIPE BOOK MODE

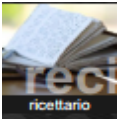

Pressing this area on the Home page opens the following screen.

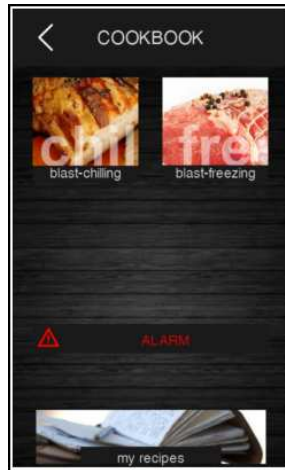

This screen grants access to a recipe book divided into two categories: blast chilling and blast-freezing.



Pressing this area opens a screen with the blast-chilling recipes.



Pressing this area opens a screen with the blast-freezing recipes.

The screen below shows an example of a blast chilling recipe book, showing the icons for the 6 recipes pre-set by the manufacturer. Pressing area  enables selection of a further list of personalised recipes saved by the user.



Pressing the relevant recipe area opens a summary screen showing the settings for the various phases of the recipe.



The recipe can be started up from this screen, or the set points can be modified by pressing the area relating to the phase. After the settings have been modified, the following options are available:

- start up the cycle without saving the changes
- save the changes and over-write the program
- save the changes under a different name

9.1 Pre-set blast chilling recipes



Phase 1	Cabinet setting	-25°C
	Needle probe setting	20°C
	Ventilation setting	5
Phase 2	Cabinet setting	-5°C
	Needle probe setting	3°C
	Ventilation setting	5
Conservation	Cabinet setting	5°C
	Needle probe setting	2°C
	Ventilation setting	5



Phase 1	Cabinet setting	-25°C
	Duration setting	27 min
	Ventilation setting	5
Phase 2	Cabinet setting	-5°C
	Duration setting	63 min
	Ventilation setting	5
Conservation	Cabinet setting	2°C
	Ventilation setting	5



Phase 1	Cabinet setting	-25°C
	Duration setting	27 min
	Ventilation setting	5
Phase 2	Cabinet setting	-5°C
	Duration setting	63 min
	Ventilation setting	5
Conservation	Cabinet setting	2°C
	Ventilation setting	5



Phase 1	Cabinet setting	-5°C
	Duration setting	90 min
	Ventilation setting	2
Conservation	Cabinet setting	2°C
	Ventilation setting	2



Phase 1	Cabinet setting	-5°C
	Duration setting	90 min
	Ventilation setting	5
Conservation	Cabinet setting	2°C
	Ventilation setting	5

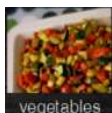

Phase 1	Cabinet setting	-5°C
	Duration setting	90 min
	Ventilation setting	5
Conservation	Cabinet setting	2°C
	Ventilation setting	5

9.2 Pre-set blast-freezing recipes

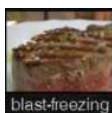

Phase 1	Cabinet setting	0°C
	Needle probe setting	3°C
	Ventilation setting	5
Phase 2	Cabinet setting	-12°C
	Needle probe setting	-3°C
	Ventilation setting	5
Phase 3	Cabinet setting	-30°C
	Needle probe setting	-18°C
	Ventilation setting	5
Conservation	Cabinet setting	5°C
	Needle probe setting	-20°C
	Ventilation setting	5

9.3 Saving a recipe

It is possible to save both time and temperature controlled cycles. In the latter case the time required to reach the core temperature is saved.

Recipes can be saved in the following ways.

- During conservation after a customized blast chilling/blast-freezing cycle. When the  key is pressed the device will offer to save the recipe used.
- Save a recipe starting from a customized cycle.
- Select a recipe already present, modify it and save it.

While saving is in progress the screen displayed will ask for the recipe category, and then show the positions free and occupied. If an occupied position is selected, the device will ask if the recipe is to be over-written, otherwise the screen shown below will open allowing the name of the recipe to be entered.

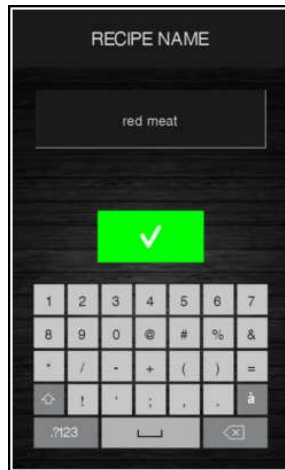

9.4 Over-writing a recipe

It is possible to over-write a recipe but not to delete it. When a recipe is being over-written the screen below will be displayed requesting confirmation of the choice.





10 PRE-COOLING MODE

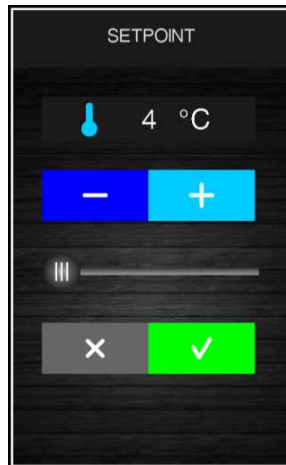

Pressing this area on the Home page enables selection of a pre-cooling cycle. This cycle is similar to a normal blast chilling cycle and it may precede all operating cycles.

Pressing the area in question opens the following screen.



Set the required set point value and press area  to start the cabinet pre-cooling cycle. The screen below will be displayed showing the pre-cooling cycle in process.



The fan speed is fixed and set by parameter F28.

This screen makes it possible to select further cycles or the  key can be pressed to stop pre-cooling.

Once the required cabinet set point has been reached, the buzzer sounds and the cycle continues maintaining the cabinet temperature achieved until the  key is pressed or until a blast chilling/blast-freezing cycle starts up. If pre-cooling is underway, it will be automatically stopped when another cycle is selected and started.

11 ADJUSTMENTS

11.1 Door frame heating output

This function is activated automatically when the board is in "on" or "run" mode and the cabinet temperature falls below the value set by parameter u5 minus the fixed hysteresis of 2°C (4°F). The output is deactivated when the temperature rises above the u5 setting.

If there is a cabinet probe error, the heaters are not activated, or if already on, they are deactivated.

11.2 Compressor management

The management of the compressor varies according to the cycle activated, as specified below.

Blast chilling, blast-freezing, pre-cooling, ice cream hardening, sanitation

The compressor is activated if the cabinet temperature is above the set point for the type of cycle underway + the hysteresis set by parameter r0. It is deactivated when the temperature falls below the set point for the phase underway.

The compressor must be switched on and off according to the safety periods set by parameters C0, C1, C2 and C3. The drip periods must also be complied with if it is activated after a defrost cycle.

When the compressor is set to switch off, the pump down solenoid valve is first deactivated and once the delay set by parameter u12 has elapsed, the compressor will also switch off.

If there is a fault with the cabinet probe during a conservation cycle, the compressor is activated on a cyclical basis according to the values of parameters C4 and C5 if this is a conservation phase following blast chilling, or according to the values of parameters C4 and C9 for conservation following blast-freezing.

Defrosting

During defrosting the compressor status depends on the value of parameter d1. If d1 equals 0, 2 or 3, the compressor is switched off.

If d1 equals 1, the compressor will remain switched on for the entire duration of the defrost cycle and if it is switched off when the defrost cycle is selected, it will be switched on for the period set by parameter d15 before defrosting starts. When defrosting is finished the compressor remains off for the period set by parameter d7.

If parameter d16 is set to a value other than 0, when a hot gas defrost cycle starts the compressor remains off for the pre-drip time set by parameter d16.

Proofing

The compressor is managed according to the neutral zone adjustment together with the heaters.

It is activated when the temperature rises above the neutral zone relative threshold (cooling). It remains active until the temperature drops within the neutral zone value.

Slow cooking

The compressor is always switched off.

11.3 Pump down solenoid valve management

The pump down solenoid valve is activated in parallel with the compressor.

When the compressor is set to switch off, the pump down solenoid valve is deactivated first and after the number of seconds set by the u12 parameter, the compressor is deactivated. This function is only available if parameter u2=0.

11.4 Evaporator fan management

The management of the evaporator fans varies according to the cycle activated, as specified below. Moreover, the management mode varies according to whether the evaporator probe is present, which can be enabled by setting parameter P4 to 1.

Blast chilling, blast-freezing, ice cream hardening, customized and continuous cycles, pre-cooling

The fans are always switched on and are only switched off if the cabinet temperature is above the value of parameter F17 and/or if the evaporator probe temperature is above the value of parameter F1. They are only switched on again if the cabinet temperature falls below the F17-F8 value and that of the evaporator probe falls below F1-F8.

Conservation

During conservation, the fans are managed according to parameter F49. If set to 0 (default), the fans will work in parallel to the compressor, if set to 1, the fans will always be active.

Sanitation (blast chilling and holding)

The fans are always switched on and are only switched off if the cabinet temperature is above the parameter F17 value and/or the evaporator probe temperature is above the parameter F1 value. They are only switched on again if the cabinet temperature falls below the F17-F8 value and that of the evaporator probe falls below F1-F8.

Sanitation (conservation)

The fans are always managed in parallel with the compressor.

Thawing

The fans are always active.

Defrosting

During defrosting the evaporator fans are switched off if the parameter d1 value is set to 0 or 1. They are switched on if d1 is set to 2 or if the door is open with d1 set at 3.

At the end of the defrosting cycle, the fans remain off for the time set by parameter F3, once the drip time set by parameter d16 has elapsed.

Proofing (blast chilling)

The fans are always switched on and are only switched off if the cabinet temperature is above the parameter F17 value and/or the evaporator probe temperature is above the parameter F1 value. They are only switched on again if the cabinet temperature falls below the F17-F8 value and that of the evaporator probe falls below F1-F8.

Proofing (re-awakening, proofing, conservation)

The fans are always active.

Slow cooking and holding

During slow cooking, the fans will be managed according to parameter F50. If the parameter is set to 0 (default), they will always be active. If set to 1, they will be active when heating elements are ON, while they will be switched on the basis of ON-OFF cycles (parameters F51 and F52) when the heating elements are OFF.

11.5 Condenser fan management

The management mode of condenser fans varies according to whether the condenser probe is present, which can be enabled by setting parameter P5 to 1. The condenser fan management varies according to the following specific cases.

Condenser probe enabled (P5=1)

The fans are always active if the compressor is switched on. If the compressor is switched off they are only activated if the condenser probe value is above the parameter F46 + the differential of 2°C/4°F. They are deactivated if the temperature is below the F46 parameter.

Condenser probe not enabled (P5=0)

The condenser fans are only active if the compressor is active. They are deactivated with a delay set by parameter F47, when the condenser is deactivated.

Condenser probe enabled but faulty

The condenser fans are activated if the compressor is activated and they are deactivated with a delay set by parameter F47.

Defrosting

The fans are managed according to the value set by parameter F48 (on or off).

11.6 Alarm output management

This activates when an alarm is set off and deactivates when the alarm stops. The output is present if parameter u1=3 or if u2=1 or u3=0.

11.7 Needle probe heating management

This output is activated by the user when the needle probe has to be removed from the blast chilled product. The output remains active until the temperature indicated by the needle probe reaches the value set by parameter u7. If within the time period set by parameter u8 this temperature is not reached, the needle probe heating function is deactivated. The door must be open during needle probe heating. The output is present if parameter u1=2 or if u3=1. The needle probe heating function can be deactivated by setting parameter u8 to 0.

11.8 Cabinet sterilisation management

This function is present if parameter E12 is set to 1.

During a sterilisation cycle the door must be closed and the output activates for the time period set by parameter u6.

Ventilation can also be activated by setting parameter u11 to 1.

The output is present if parameter u1=1.

11.9 Defrost output management

During defrosting outputs are managed according to the type of defrost set by parameter d1.

The defrost output will be activated regardless of the value of parameter d1 for the entire duration of the defrost.

11.10 Thawing heater management

These are activated during thawing to bring the cabinet temperature to the set point value. Heaters have a neutral zone adjustment.

11.11 Proofing and slow cooking heater management

Proofing

When the temperature falls below the neutral zone relative threshold (heating), the heaters will be activated until the neutral zone temperature is restored. The heaters are activated as ON and OFF cycles given by parameters rH14 and rH15.

Slow cooking

The heaters are activated to bring the temperature to the set point value.

11.12 Humidifier management

This function is activated on the basis of the humidity percentage set. For example, if this is set at 60%, the output is activated for 60% of the time set by parameter rU3 and deactivated for the time set by rU2 – rU3. The ON and OFF humidifying cycle repeats itself until the phase is finished.

11.13 Humidifying/steam generator heater management

This function is activated at the beginning of a cycle for which humidifying is required and it remains active for the entire duration of the cycle.

11.14 Cabinet light management

If present, the light comes on when the door is opened and switches off when it is closed. The output is present if parameter u1=0.

12 SETTINGS

The SETTINGS are accessed by pressing area  on the Home page. The page displays the following menu:

- service
- set-up
- select language



12.1 Service

The SERVICE area displays the list of available functions, as follows.

- alarms
- input and output status
- compressor operating hours
- set date/time
- select HACCP data
- reset compressor operating hours
- reset HACCP alarms.

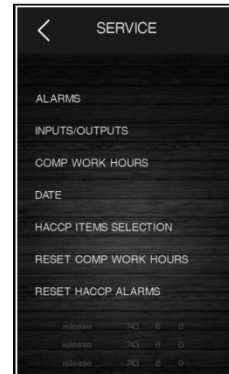

To access “reset compressor operating hours” and “reset HACCP data” it is necessary to enter the password 149.

12.2 Setup

The SETUP area can only be accessed after the password -19 has been entered. This area grants access to the following functions:

- configure parameters
- restore default values (as in the parameter table in Chapter 14).



12.3 Select language

The following languages can be selected:
 Italian, English, French, Dutch, Spanish, Portuguese,
 Chinese (simplified), Chinese (Traditional).



13 USING THE USB PORT

13.1 Initial information

The USB port makes possible the following operations.

- download and upload recipes
- download and upload configuration parameters
- download historical HACCP information.

Uploading operations are only possible if the firmware of the device from which it originates and the firmware of the destination device(s) are the same.

These operations are guaranteed by using an EVCO EVUSB4096M USB device.

To access these functions, switch the card to "off" and connect a USB device to the port. The following screen will be displayed.

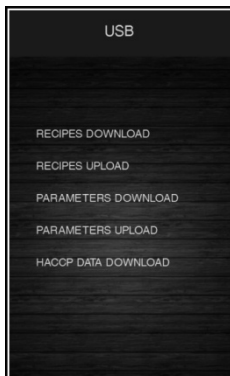

13.2 Download/upload recipes

After connecting the USB device and selecting "download recipes" or "upload recipes", the programs will be automatically written/read in the form of a text document entitled "program.bin"; the write/read operation may take some minutes.

When the operation is complete, remove the USB device from the USB serial port.



13.3 Download/upload parameters

After connecting the USB device and selecting "download parameters" or "upload parameters", the configuration parameters will be automatically written/read in the form of a text document entitled "param.bin"; the write/read operation may take some minutes.

When the operation is complete, remove the USB from the USB serial port.



13.4 Download HACCP data

After connecting the USB device and selecting "download HACCP data", a page will appear allowing you to select the time you want the historical log to be started from (keep the day/month/year/hour area pressed until it will become green, then edit by pressing the + and - keys to set the desired value). Once you confirm, a CSV (comma separated values) document will be automatically written in the device; For example, the file named "storico.csv".

The write operation may take some minutes; when the operation is complete, remove the USB from the USB serial port.

In Chinese the data in the storico.csv file will be archived in English.

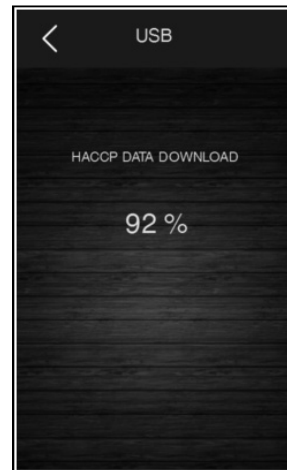

14 EPOCA CLOUD PLATFORM

EPoCA is a remote monitoring system based on a cloud platform. All that is needed is a simple onsite Wi-Fi internet connection to enable the controller, using EVlink Wi-Fi module, to connect to the cloud system, making it possible to remotely manage equipment from a PC, tablet or smartphone.

The responsive design and the graphic interface conceived to provide a pleasant user experience make EPoCA a ready-to-use solution for easily accessible monitoring operations, even for entry-level users, while offering all the typical functions of professional platforms.

With appropriate protection measures for access and data, the system makes it possible for one or more enabled users to operate remotely on the unit to configure its parameters, view HACCP data (also in graphic form) and to download records in the most popular formats, such as XLSX, CSV and PDF. The functions playing a key role include alarm warnings sent automatically by the system to selected e-mail addresses.

Schematic diagram:

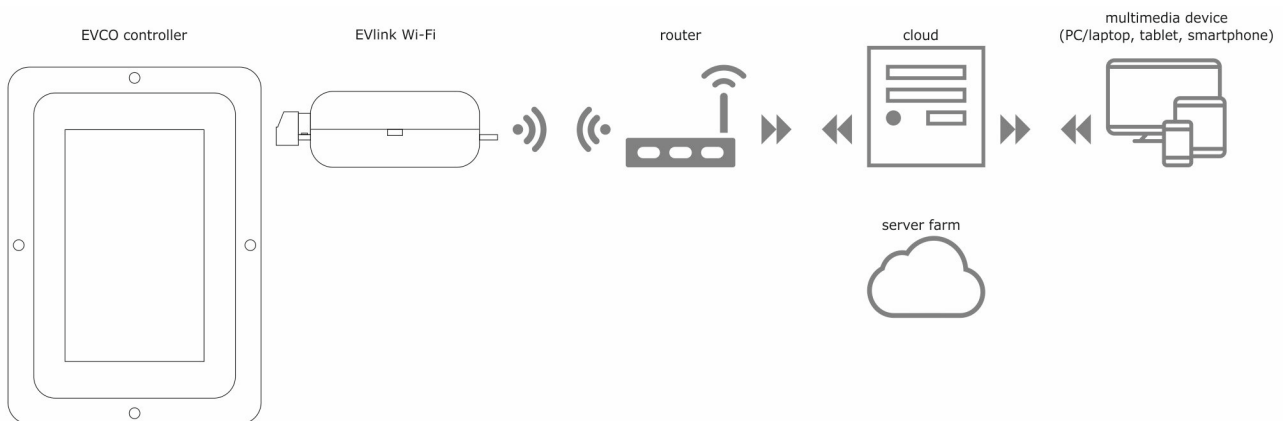

For more details on the EVlink Wi-Fi module and on the EPoCA cloud platform, please check out the "EPoCA" manual in our website www.evco.it.

15 LIST OF CONFIGURATION PARAMETERS

The following table gives the meaning of the configuration parameters.

N.B. Because some functions are managed according to the value set for some parameters, ensure these are set correctly and consistently.

PAR.	DEFAULT	MIN.	MAX.	U.M.	ANALOGUE INPUTS
CA1	0	-25	25	°C/°F ⁽¹⁾	Cabinet probe calibration
CA2	0	-25	25	°C/°F ⁽¹⁾	Evaporator probe calibration (if P4=1)
CA3	0	-25	25	°C/°F ⁽¹⁾	Condenser probe calibration (if P5=1)
CA4	0	-25	25	°C/°F ⁽¹⁾	Needle probe 1 calibration
CA5	0	-25	25	°C/°F ⁽¹⁾	Needle probe 2 calibration (if P9>1)
CA6	0	-25	25	°C/°F ⁽¹⁾	Needle probe 3 calibration (if P9>1)
P0	0	0	1	----	Type of probe 0 = PTC 1 = NTC
P2	0	0	1	----	Temperature measurement unit 0 = °C 1 = °F
P3	1	0	3	----	Type of needle probe 0 = not enabled 1 = single probe 2 = multineedle probe 3 = multi-sensor probe See also P9
P4	1	0	1	----	Enable evaporator probe 0 = no 1 = yes
P5	1	0	1	----	Enable condenser probe 0 = no 1 = yes
P9	3	1	3	----	If P3=1, P9 must be set to 1 If P3=2, the number set for P9 corresponds to the number of needle probes present (from 1 to 3) If P3 = 3, the number set for P9 corresponds to the number of sensors in the needle probe

PAR.	DEFAULT	MIN.	MAX.	U.M.	MAIN REGULATOR
r0	2	1	15	°C/°F ⁽¹⁾	Cabinet set point differential in blast chilling, blast-freezing, sanitation, ice cream hardening and customized cycles.
r1	90	1	500	min	Duration of time controlled blast chilling
r2	240	1	500	min	Duration of time controlled blast-freezing
r3	3	-50	99	°C/°F ⁽¹⁾	Product temperature to end temperature controlled blast chilling and to end the soft phase in temperature controlled soft blast-freezing. See also parameter r5
r4	-18	-50	99	°C/°F ⁽¹⁾	Product temperature to end temperature controlled blast-freezing. See also parameter r6.
r5	90	1	500	min	Maximum permitted duration for temperature controlled blast chilling. See also parameter r3
r6	240	1	500	min	Maximum permitted duration for temperature controlled blast-freezing. See also parameter r4
r7	0	-50	99	°C/°F ⁽¹⁾	Cabinet temperature set point during blast chilling and the soft phase of soft blast-freezing. See also parameter r0
r8	-40	-50	99	°C/°F ⁽¹⁾	Cabinet temperature set point during blast-freezing and ice cream hardening. See also parameter r0.
r9	-20	-50	99	°C/°F ⁽¹⁾	Cabinet temperature set point during the hard phase of hard blast chilling. See also parameter r0.
r10	2	-50	99	°C/°F ⁽¹⁾	Cabinet temperature set point during conservation after blast chilling, hard blast chilling and continuous cycle. See also parameter r0
r11	-20	-50	99	°C/°F ⁽¹⁾	Cabinet temperature set point during conservation after blast-freezing and soft blast-freezing. See also parameter r0
r12	5	-50	99	°C/°F ⁽¹⁾	Cabinet temperature set point during pre-cooling. See also parameter r0
r13	15	-50	99	°C/°F ⁽¹⁾	Product temperature to end the hard phase of hard temperature controlled blast chilling.
r14	60	10	100	%	Duration of the hard phase of hard time controlled blast chilling (i.e. the percentage of the value set by parameter r1). Duration of the soft phase of time controlled soft blast-freezing (i.e. the percentage of the value set by parameter r2)
r15	65	-50	199	°C/°F ⁽¹⁾	Product temperature below which the count for maximum duration begins for temperature controlled blast chilling or blast-freezing.
r17	5	0	99	°C/°F ⁽¹⁾	Minimum gap between the product and cabinet temperatures, according to which the first phase of the test for correct insertion of the needle probe is considered successfully completed 0 = the test is disabled and the needle probe is considered always inserted
r18	80	10	999	s	Duration of the second phase of the test for correct insertion of the needle probe.
r19	-40	-50	+99	°C/°F ⁽¹⁾	Cabinet temperature set point for the first phase of sanitation.

r20	-20	-50	99	°C/°F ⁽¹⁾	Product temperature set point for the first phase of sanitation and cabinet temperature set point for the second phase of sanitation.
r21	24	0	24	h	Duration of second sanitation phase.
r22	-20	-50	99	°C/°F ⁽¹⁾	Cabinet temperature set point for the third phase of sanitation.
r23	5	1	99	h	Maximum duration of the first sanitation phase.
r24	10	1	400	min	Duration of ice cream hardening cycle.
r25	25	-50	99	°C/°F ⁽¹⁾	Initial cabinet temperature set point for light-load thawing.
r26	30	-50	99	°C/°F ⁽¹⁾	Initial cabinet temperature set point for medium-load thawing.
r27	35	-50	99	°C/°F ⁽¹⁾	Initial cabinet temperature set point for heavy-load thawing.
r28	10	-50	99	°C/°F ⁽¹⁾	Final cabinet temperature set point for light-load thawing.
r29	12	-50	99	°C/°F ⁽¹⁾	Final cabinet temperature set point for medium-load thawing.
r30	15	-50	99	°C/°F ⁽¹⁾	Final cabinet temperature set point for heavy-load thawing.
r31	3	-50	99	°C/°F ⁽¹⁾	Cabinet temperature set point for post-thawing conservation.
r32	240	1	999	min	Light-load thawing duration.
r33	480	1	999	min	Medium-load thawing duration.
r34	720	1	999	min	Heavy-load thawing duration.
r35	-15	-50	99	°C/°F ⁽¹⁾	Cabinet temperature set point for customized blast chilling.
r36	10	-50	99	°C/°F ⁽¹⁾	Product temperature set point for customized blast chilling.
r37	240	1	999	min	Duration of time controlled customized blast chilling.
r38	5	-50	99	°C/°F ⁽¹⁾	Cabinet temperature set point for conservation after customized blast chilling.
r39	80	-50	99	°C/°F ⁽¹⁾	Maximum cabinet temperature set-point that can be set
PAR.	DEFAULT	MIN.	MAX.	U.M.	COOLING REGULATOR (parameters only valid if E12=1)
rC0	2	1	15	°C/°F ⁽¹⁾	Parameter rC3 differential.
rC3	5	-50	99	°C/°F ⁽¹⁾	Cabinet temperature set point for blast chilling phase (for proofing cycle).
rC4	1	0	10	°C/°F ⁽¹⁾	Neutral zone relative threshold (cooling) for all proofing phases.
PAR.	DEFAULT	MIN.	MAX.	U.M.	HEATING REGULATOR (parameters only valid if E12=1)
rH0	2	1	15	°C/°F ⁽¹⁾	Parameter rH3, rH4, rH5, rH10 and rH13 differential.
rH3	20	-50	99	°C/°F ⁽¹⁾	Cabinet temperature set point for re-awakening phase.
rH4	30	-50	99	°C/°F ⁽¹⁾	Cabinet temperature set point for proofing phase.

rH5	25	-50	99	°C/°F ⁽¹⁾	Cabinet temperature set point for holding phase.
rH6	1	0	10	°C/°F ⁽¹⁾	Neutral zone relative threshold (heating) for all proofing phases.
rH7	120	0	999	Min	Blast chilling phase duration (for proofing cycle).
rH8	240	0	999	Min	Re-awakening phase duration.
rH9	180	0	999	Min	Proofing phase duration.
rH10	80	-50	99	°C/°F ⁽¹⁾	Cabinet temperature set point for slow cooking.
rH11	60	-50	99	°C/°F ⁽¹⁾	Product temperature set point for slow cooking.
rH12	60	0	999	Min	Slow cooking duration.
rH13	60	-50	99	°C/°F ⁽¹⁾	Cabinet temperature set point for holding.
rH14	45	1	600	s	Heater cycle time for proofing.
rH15	4	1	10	s	Heater on time for proofing.
rH16	1	0	10	°C/°F ⁽¹⁾	Neutral zone relative threshold for thawing.
rH17	2	1	15	°C/°F ⁽¹⁾	Cabinet set point differential for activating heater during thawing.
rH18	2	1	15	°C/°F ⁽¹⁾	Cabinet set point differential for activating compressor during thawing.
rH19	45	1	600	s	Heater cycle time for thawing.
rH20	4	1	10	s	Heater on time for thawing.
PAR.	DEFAULT	MIN.	MAX.	U.M.	HUMIDITY REGULATOR (parameters only valid if E12=1)
rU1	0	-50	99	°C/°F ⁽¹⁾	Cabinet temperature under which humidifying is inhibited.
rU2	60	1	600	s	Cycle time for switching on humidifier for proofing and slow cooking.
rU3	30	1	600	s	Humidifier on time within the rU2 cycle time for generating 100% humidity in the cabinet.
rU4	0	0	1	----	Enable humidifying control during blast chilling phase (for proofing cycle) 0 = no 1 = yes
rU5	60	0	100	%	Pre-set % humidifying for blast chilling (for proofing cycle), if parameter rU4=1.
rU6	60	0	100	%	Pre-set % humidifying during re-awakening.
rU7	80	0	100	%	Pre-set % humidifying during proofing.
rU8	80	0	100	%	Pre-set % humidifying during holding.
rU9	80	0	100	%	Pre-set % humidifying during slow cooking.
rU10	80	0	100	%	Pre-set % humidifying during holding after slow cooking.

PAR.	DEFAULT	MIN.	MAX.	U.M.	COMPRESSOR PROTECTION
C0	0	0	240	min	Minimum time between restoration of power supply after a power failure happening during an operating cycle and compressor switch-on.
C1	5	0	240	min	Minimum time between two consecutive compressor switch-ons.
C2	3	0	240	min	Minimum time between compressor switch-off and subsequent switch-on.
C3	0	0	240	min	Minimum compressor-on time.
C4	10	0	240	min	Compressor-off time during cabinet probe error (" CABINET PROBE " code) happening during conservation after blast chilling and blast-freezing. See also parameters C5 and C9
C5	10	0	240	min	Compressor-on time during cabinet probe error (" CABINET PROBE " code) happening during conservation after blast chilling. See also parameter C4.
C6	80	0	199	°C/°F ⁽¹⁾	Condenser temperature above which the condenser overheating alarm is activated (" COND OVERHEAT " code).
C7	90	0	199	°C/°F ⁽¹⁾	Condenser temperature above which the compressor locked alarm is activated (" COMP LOCKED " code), once the time set for C8 has elapsed.
C8	1	0	15	min	Activation delay of the compressor locked alarm (" COMP LOCKED " code) due to threshold C7 exceeded.
C9	30	0	240	min	Compressor-on time during cabinet probe error (" CABINET PROBE " code) happening during conservation after blast-freezing. See also parameter C4
PAR.	DEFAULT	MIN.	MAX.	U.M.	DEFROSTING
d0	8	0	99	h	Defrost interval 0 = defrost at intervals is never activated.
d1	1	0	4	- - - -	Type of defrost 0 = electrical (during defrosting the compressor is switched off, the defrost output is activated and the evaporator fan switched off). 1 = hot gas (during defrosting the compressor is switched on, the defrost output is activated and the evaporator fan is switched off). 2 = air (during defrosting the compressor is switched off and the defrost output is activated. The evaporator fan is switched on, regardless of the door status, or regardless of the status of the door switch input) 3 = air with the door open (during defrosting the compressor is switched off and the defrost output is activated. The evaporator fan is switched on, provided the door is open or provided the door switch input is on and that parameter i0 is set to a value other than 0).
d2	2	-50	99	°C/°F ⁽¹⁾	Evaporator temperature to end defrosting. See also parameter d3

d3	30	0	99	min	<p>If the evaporator probe is not present (P4=0), it sets the defrost duration.</p> <p>If the evaporator probe is present (P4=1), it sets the maximum defrost duration. See also parameter d2</p> <p>0 = defrost is never activated.</p>
d4	0	0	1	----	<p>Enable defrost at the start of blast chilling and of blast-freezing</p> <p>0 = no</p> <p>1 = yes</p>
d5	30	0	99	min	<p>Defrost delay from the beginning of conservation</p> <p>0 = defrost will be activated once the time set by d0 has elapsed.</p>
d7	2	0	15	min	<p>Drip time after a defrost, in which the compressor and the evaporator fan are switched off and the defrost output is deactivated.</p>
d15	0	0	99	min	<p>Minimum consecutive compressor-on duration for starting hot gas defrost, if d1 is set to 1</p>
d16	0	0	99	min	<p>Pre-drip time if d1 is set to 1 (hot gas defrost), in which the compressor and the evaporator fan are off and the defrost output remains activate.</p>
PAR.	DEFAULT	MIN.	MAX.	U.M.	TEMPERATURE ALARMS
A1	10	0	99	°C/°F ⁽¹⁾	<p>Cabinet temperature below which the minimum temperature alarm is activated (in relation to the working set point, i.e. "r10-A1" during conservation after blast chilling and "r11-A1" during conservation after blast-freezing; ("LOW TEMPERATURE" code). See also parameter A11</p>
A2	1	0	1	----	<p>Enable minimum temperature alarm ("LOW TEMPERATURE" code):</p> <p>0 = no</p> <p>1 = yes</p>
A4	10	0	99	°C/°F ⁽¹⁾	<p>Cabinet temperature above which the maximum temperature alarm is activated (relating to the working set point, i.e. "r10+A4" during conservation after blast chilling and "r11+A4" during conservation after blast-freezing ("HIGH TEMPERATURE" code). See also parameter A11 (4)</p>
A5	1	0	1	----	<p>Enable maximum temperature alarm ("HIGH TEMPERATURE" code):</p> <p>0 = no</p> <p>1 = yes</p>
A7	15	0	240	min	<p>Temperature alarm delay ("HIGH TEMPERATURE" code and "LOW TEMPERATURE" code)</p>
A8	15	0	240	min	<p>Maximum temperature alarm delay ("HIGH TEMPERATURE" code) from the end of the evaporator fan-off time and from the beginning of conservation.</p>
A10	5	0	240	min	<p>Power failure duration sufficient for the power failure alarm to be saved ("POWER FAILURE" code) when this is restored</p> <p>0 = the alarm will not be signalled</p>
A11	2	1	15	°C/°F ⁽¹⁾	<p>Parameter A1 and A4 differential</p>

A12	5	0	240	s	Duration of buzzer activation on completion of blast chilling and blast-freezing.
A13	60	0	240	s	Duration of alarm buzzer activation.
PAR.	DEFAULT	MIN.	MAX.	U.M.	EVAPORATOR AND CONDENSER FANS
F1	-1	-50	99	°C/°F ⁽¹⁾	The evaporator temperature above which the evaporator fan switches off during pre-cooling/blast chilling/blast-freezing/sanitation/ice cream hardening/blast chilling (for proofing cycle). See also parameter F8.
F3	2	0	15	min	Duration of evaporator fan-off time (while the evaporator fan is off the compressor may be switched on, the defrost output is de-activated and the evaporator fan stays off).
F8	2	1	15	°C/°F ⁽¹⁾	Parameter F1 and F17 differential.
F15	15	0	240	s	Evaporator fan delay from when the door is closed, or the door switch input is deactivated.
F17	90	-50	199	°C/°F ⁽¹⁾	Cabinet temperature above which the evaporator fan is switched off during pre-cooling/blast chilling/blast-freezing/sanitation/ice cream hardening/blast chilling (for proofing cycle). See also parameter F8.
F19	20	0	100	%	Evaporator fan minimum speed calibration.
F20	80	0	100	%	Evaporator fan maximum speed calibration.
F21	80	0	100	%	Start-up speed.
F22	5	0	10	s	Start-up time.
F23	5	1	5	----	Fan speed during blast chilling and soft blast-freezing phase.
F24	5	1	5	----	Fan speed during hard blast chilling phase.
F25	5	1	5	----	Fan speed during blast-freezing and ice cream hardening.
F26	5	1	5	----	Fan speed during positive conservation.
F27	5	1	5	----	Fan speed during negative conservation.
F28	5	1	5	----	Fan speed during pre-cooling.
F29	1	1	5	----	Fan speed in first thawing phase.
F30	1	1	5	----	Fan speed in second thawing phase.
F31	1	1	5	----	Fan speed in third thawing phase.
F32	1	1	5	----	Fan speed in fourth thawing phase.
F33	1	1	5	----	Fan speed in fifth thawing phase.
F34	1	1	5	----	Fan speed during conservation after thawing.
F35	5	1	5	----	Fan speed in first sanitation phase (blast chilling).
F36	5	1	5	----	Fan speed in second sanitation phase (holding).
F37	5	1	5	----	Fan speed in third sanitation phase (conservation).

F38	5	1	5	----	Fan speed during customized blast chilling.
F39	5	1	5	----	Fan speed during customized conservation.
F40	5	1	5	----	Fan speed during slow cooking.
F41	5	1	5	----	Fan speed during holding after slow cooking.
F42	5	1	5	----	Fan speed during blast chilling (for proofing cycle)
F43	5	1	5	----	Fan speed during re-awakening.
F44	5	1	5		Fan speed during proofing.
F45	5	1	5		Fan speed during conservation (for proofing cycle)
F46	15	0	99	°C/°F ⁽¹⁾	Condenser temperature above which the condenser fan switches on.
F47	30	0	240	s	Condenser fan switch-off delay from when the compressor is switched off (only if the condenser probe is not present).
F48	---	0	1	0	Condenser fan status during defrosting. 0 = off 1 = on
F49	0	0	1	---	Fan operating mode during conservation 0 = parallel to the compressor 1 = always ON
F50	0	0	1	---	Fan operating mode during slow cooking 0 = always ON 1 = ON if heating elements are ON, with ON-OFF cycles if heating elements are OFF
F51	180	0	999	s	Fan OFF time during heating when operating with F50 = 1
F52	60	0	999	s	Fan ON time during heating when operating with F50 = 1
F53	1	1	5	---	Minimum fan speed that can be set for all cycles except slow cooking <u>NB: check that the value set is consistent with parameters from F23 to F45</u>
F54	1	1	5	---	Minimum fan speed that can be set for slow cooking <u>NB: check that the value set is consistent with parameters from F23 to F45</u>

PAR.	DEFAULT	MIN.	MAX.	U.M.	DIGITAL INPUTS
i0	2	0	2	----	<p>Effect caused by the door opening, or when the door switch input is activated.</p> <p>0 = no effect and no signal</p> <p>1 = the compressor, evaporator fan, thawing heater, heater and humidifier are switched off and the cabinet light is on, once the time set by parameter i2 has elapsed, the device displays the alarm and the buzzer is activated until the door is closed. See also parameter F15</p> <p>2 = the evaporator fan is switched off and the cabinet light is on, once the time set by parameter i2 has elapsed, the device displays the alarm and the buzzer is activated until the door is closed. See also parameter F15.</p>
i1	0	0	1	----	<p>Door switch input polarity</p> <p>0 = normally open (input active with contact closed)</p> <p>1 = normally closed (input active with contact open)</p>
i2	5	-1	120	min	<p>Door-open time for door-open alarm record;</p> <p>-1 = alarm not signalled.</p>
i5	-	-	-	----	unused
i6	0	0	1	----	<p>High pressure input polarity</p> <p>0 = normally open (input active with contact closed)</p> <p>1 = normally closed (input active with contact open)</p>
i7	5	-1	240	s	<p>High-pressure alarm signal delay</p> <p>-1 = alarm not signalled</p>
i8	-	-	-	----	unused
i9	0	0	1	----	<p>Low pressure input polarity</p> <p>0 = normally open (input active with contact closed)</p> <p>1 = normally closed (input active with contact open)</p>
i10	5	-1	240	s	<p>Low-pressure alarm signal delay</p> <p>-1 = alarm not signalled</p>
i11	0	0	1	----	<p>Thermal switch input polarity</p> <p>0 = normally open (input active with contact closed)</p> <p>1 = normally closed (input active with contact open)</p>
i12	5	-1	240	s	<p>Thermal switch alarm signal delay</p> <p>-1 = alarm not signalled</p>
i13	-	-	-	----	unused

PAR.	DEFAULT	MIN.	MAX.	U.M.	DIGITAL OUTPUTS
u1	2	0	3	- - - -	Function managed by output K9 0= cabinet light 1= UV lamp 2= needle probe heating 3=alarm
u2	0	0	1	- - - -	Function managed by output K8 0= pump down solenoid valve 1=alarm
u3	0	0	1	- - - -	Function managed by output K7 0=alarm 1= needle probe heating
u4	0	0	1	- - - -	K2 and K5 output exchange 0= door heater on K5 and defrost on K2 1= door heater on K2 and defrost on K5
u5	2	-50	99	°C/°F ⁽¹⁾	Cabinet temperature over which the door heaters are switched off
u6	5	1	240	min	Time the UV lamp is on for the sterilisation cycle (only valid if u1=1).
u7	40	-50	199	°C/°F ⁽¹⁾	Temperature to end needle probe heating. See also parameter u8 (only valid if u1=2 or if u3=1).
u8	2	0	240	min	Maximum duration of needle probe heating. See also parameter u7 (only valid if u1=2 or if u3=1) 0 = needle probe heating is disabled.
u9	-	-	-	- - - -	unused
u11	0	0	1	- - - -	Enable evaporator ventilation during sterilisation (only valid if u1=1). 0=no 1=yes
u12	10	0	999	s	Compressor switch-off delay from deactivation of the pump down valve (pump down being switched off)
u13	25	1	99	m	Drying duration
PAR.	DEFAULT	MIN.	MAX.	U.M.	SERIAL COMMUNICATION (serial port type RS-485 with MODBUS communication protocol).
PA1	426	-99	999	- - - -	Level 1 password
PA2	824	-99	999	- - - -	Level 2 password
bLE	1	0	99	- - - -	Serial port connectivity configuration 0 = free 1 = forced for EPoCA 2-99 = EPoCA local network address

L1	5	1	240	min	Data recording interval during blast chilling, blast-freezing, ice cream hardening, fish sanitation and thawing, proofing and slow cooking (if enabled by E12=1); also recording interval EVlink Wi-Fi
L2	-	-	-	----	unused
LA	247	1	247	----	device address
Lb	2	0	3	----	baud rate 0 = 2,400 Bd 1 = 4,800 Bd 2 = 9,600 Bd 3 = 19,200 Bb
LP	2	0	2	----	parity 0 = none 1 = odd 2 = even
PAR.	DEFAULT	MIN.	MAX.	U.M.	MISCELLANEOUS
E7	0	0	1	----	Activate "lock keypad" function 0 = function not enabled 1 = automatic with temporary effect (60s time lapse from the time the key was pressed while a cycle is in progress, the keypad locks automatically).
E8	60	30	600	s	Time-out for keypad lock
E9	1	0	1	----	Display EVCO splash screen when power is restored 0 = no 1 = yes
E12	0	0	1	----	Expansion required (necessary for the management of slow cooking and proofing) 0 = no 1 = yes

Notes

(1) the unit of measurement depends on parameter P2

16 ALARMS

16.1 Alarms

The table below lists the various alarms.

Code	Meaning
RTC	Clock error. To correct <ul style="list-style-type: none"> - Re-set the date and time. Main consequences <ul style="list-style-type: none"> - The device will not memorise the date and time an HACCP alarm happened. - The alarm output will be activated.
CABINET PROBE	Cabinet probe error. To correct <ul style="list-style-type: none"> - Check the parameter P0 value. - Check that the probe is undamaged. - Check the device-probe connection. - Check the cabinet temperature. Main consequences <ul style="list-style-type: none"> - If the error happens during stand-by, it will not be possible to set or start any operating cycle. - If the error happens during blast chilling or blast-freezing, the cycle will continue with the compressor in continuous mode. - If the error happens during conservation, the compressor will operate according to parameters C4 and C5 or C9. - If the error happens during a proofing, slow cooking or a thawing cycle, the cycle will be interrupted. - The minimum temperature alarm will never be activated. - The maximum temperature alarm will never be activated. - The door heaters will never be switched on. - The alarm output will be activated.
EVAPORATOR PROBE	Evaporator probe error. To correct: <ul style="list-style-type: none"> - The same as for the cabinet probe error but with reference to the evaporator probe. Main consequences <ul style="list-style-type: none"> - If parameter P4 is set to 1, defrosting will last for the time set by parameter d3. - Parameter F1 will have no effect. - The alarm output will be activated.

<p>CONDENSER PROBE</p>	<p>Condenser probe error.</p> <p>To correct</p> <ul style="list-style-type: none"> - The same as for the cabinet probe error but with reference to the condenser probe. <p>Main consequences</p> <ul style="list-style-type: none"> - The condenser fan will operate in parallel with the compressor. - The condenser overheat alarm will never be activated. - The compressor locked alarm will never be activated. - The alarm output will be activated.
<p>NEEDLE PROBE SENSOR 1</p>	<p>Needle probe/sensor 1 error.</p> <p>To correct</p> <ul style="list-style-type: none"> - The same as for the cabinet probe error but with reference to needle probe 1. <p>Main consequences if parameter P3 is set to 1 (single probe)</p> <ul style="list-style-type: none"> - If the error happens during stand-by, the temperature controlled cycles will be started up as time-controlled. - If the error happens during temperature controlled blast chilling, blast chilling will last for the time set by parameter r1 - If the error happens during temperature controlled blast-freezing, blast-freezing will last for the time set by parameter r2 - If the error happens during needle probe heating, the heating will be interrupted. - The alarm output will be activated. <p>Main consequences if parameter P3 is set to 2 or 3 (multineedle or multi-sensor probes)</p> <ul style="list-style-type: none"> - The device will not use the probe/sensor showing the error but the other available probes or sensors will be used.
<p>NEEDLE PROBE SENSOR 2</p>	<p>Needle probe/sensor 2 error.</p> <p>To correct</p> <ul style="list-style-type: none"> - The same as for the cabinet probe error but with reference to needle probe 2. <p>Main consequences</p> <ul style="list-style-type: none"> - The device will not use needle probe 2.
<p>NEEDLE PROBE SENSOR 3</p>	<p>Needle probe/sensor 3 error.</p> <p>To correct</p> <ul style="list-style-type: none"> - The same as for the cabinet probe error but with reference to needle probe 3. <p>Main consequences</p> <ul style="list-style-type: none"> - The device will not use needle probe 3.
<p>THERMAL SWITCH</p>	<p>Thermal switch alarm</p> <p>To correct</p> <ul style="list-style-type: none"> - Check the state of the thermal switch input. - Check the value of parameter i11. <p>Main consequences</p> <ul style="list-style-type: none"> - The cycle in progress will be interrupted - The alarm output will be activated.

HIGH PRESSURE SWITCH	<p>High pressure alarm.</p> <p>To correct</p> <ul style="list-style-type: none"> - Check the state of the high pressure input. - Check the value of parameter i6. <p>Main consequences</p> <ul style="list-style-type: none"> - If the cycle underway requires use of the compressor, the cycle will be interrupted. - The alarm output will be activated.
LOW PRESSURE SWITCH	<p>Low pressure alarm.</p> <p>To correct:</p> <ul style="list-style-type: none"> - Check the state of the low pressure input. - Check the value of parameter i9. <p>Main consequences</p> <ul style="list-style-type: none"> - If the cycle underway requires use of the compressor, the cycle will be interrupted. - The alarm output will be activated.
DOOR OPEN	<p>Door open alarm.</p> <p>To correct</p> <ul style="list-style-type: none"> - Check the door status. - Check the value of parameters i0 and i1. <p>Main consequences</p> <ul style="list-style-type: none"> - The effect set by parameter i0. - The alarm output will be activated.
HIGH TEMPERATURE	<p>Maximum temperature alarm (HACCP alarm).</p> <p>To correct</p> <ul style="list-style-type: none"> - Check the cabinet temperature. - Check the value of parameters A4 and A5. <p>Main consequences</p> <ul style="list-style-type: none"> - The device will memorise the alarm. - The alarm output will be activated.
LOW TEMPERATURE	<p>Minimum temperature alarm (HACCP alarm).</p> <p>To correct</p> <ul style="list-style-type: none"> - Check the cabinet temperature. - Check the value of parameters A1 and A2. <p>Main consequences</p> <ul style="list-style-type: none"> - The device will memorise the alarm. - The alarm output will be activated.
CYCLE DURATION	<p>Alarm indicating that temperature controlled blast chilling or blast-freezing has not been completed within the maximum duration (HACCP alarm).</p> <p>To correct</p> <ul style="list-style-type: none"> - Check the value of parameters r5 and r6. <p>Main consequences</p> <ul style="list-style-type: none"> - The device will memorise the alarm. - The alarm output will be activated.

<p>BOARD COMMUNICATIONS</p>	<p>User interface-control module communication error.</p> <p>To correct</p> <ul style="list-style-type: none"> - Check the user interface-control module connection. <p>Main consequences</p> <ul style="list-style-type: none"> - Any cycle underway will be terminated and it will not be possible to start one up.
<p>BOARD COMPATIBILITY</p>	<p>User interface-control module compatibility error.</p> <p>To correct</p> <ul style="list-style-type: none"> - Check that the user interface and the control module are compatible. <p>Main consequences</p> <ul style="list-style-type: none"> - Any cycle underway will be terminated and it will not be possible to start one up.
<p>NEEDLE PROBE</p>	<p>Needle probe alarm (all the needle probe sensors enabled are in alarm status)</p> <p>To correct</p> <ul style="list-style-type: none"> - The same as for the cabinet probe error but with reference to all the needle probes. <p>Main consequences</p> <ul style="list-style-type: none"> - Any temperature controlled cycle will be interrupted
<p>POWER FAILURE</p>	<p>Power failure alarm (HACCP alarm).</p> <p>To correct</p> <ul style="list-style-type: none"> - Check the device-power supply connection. <p>Main consequences:</p> <ul style="list-style-type: none"> - The device will memorise the alarm. - Any cycle underway will resume when power is restored. - The alarm output will be activated.
<p>SANITATION PROBE INSERTION</p>	<p>Sanitation alarm.</p> <p>To correct</p> <ul style="list-style-type: none"> - Check that the needle probe has been correctly inserted and check the value of parameters r17 and r18. <p>Main consequences</p> <ul style="list-style-type: none"> - The sanitation cycle will be interrupted.
<p>SANITATION DURATION</p>	<p>Alarm indicating that sanitation has not been completed within the maximum duration (HACCP alarm).</p> <p>To correct</p> <ul style="list-style-type: none"> - Check the value of parameter r23 <p>Main consequences</p> <ul style="list-style-type: none"> - The device will memorise the alarm. - The cycle underway will be interrupted. - The alarm output will be activated.
<p>CONDENSER OVERHEAT</p>	<p>Condenser overheat alarm.</p> <p>To correct</p> <ul style="list-style-type: none"> - Check the condenser temperature. - Check the value of parameter C6. <p>Main consequences</p> <ul style="list-style-type: none"> - The condenser fan will be switched on. - The alarm output will be activated.

<p>COMPRESSOR LOCKED</p>	<p>Compressor locked alarm.</p> <p>To correct</p> <ul style="list-style-type: none"> - Check the condenser temperature - Check the value of parameter C7 - Disconnect the device from the power supply and clean the condenser. <p>Main consequences</p> <ul style="list-style-type: none"> - If the error happens during "stand-by", it will not be possible to select or start up an operating cycle. - If the error happens during an operating cycle, the cycle will be interrupted. - The alarm output will be activated.
<p>NEEDLE PROBE INSERTION</p>	<p>Needle probe not inserted alarm.</p> <p>To correct</p> <ul style="list-style-type: none"> - Check that the needle probes have been correctly inserted and check the value of parameters r17 and r18. <p>Main consequences</p> <ul style="list-style-type: none"> - The temperature controlled cycle in progress will be converted to a time controlled cycle.
<p>EXPANSION COMMUNICATIONS</p>	<p>User interface-expansion module communication error.</p> <p>To correct</p> <ul style="list-style-type: none"> - Check the user interface-expansion module connection. <p>Main consequences</p> <ul style="list-style-type: none"> - Any proofing or slow cooking cycle underway will be terminated and it will not be possible to start one up.
<p>EXPANSION COMPATIBILITY</p>	<p>User interface-expansion module compatibility error.</p> <p>To correct</p> <ul style="list-style-type: none"> - Check the user interface and expansion module are compatible. <p>Main consequences</p> <ul style="list-style-type: none"> - Any cycle underway will be terminated and it will not be possible to start one up.

16.2 HACCP alarms

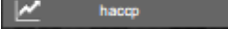
To access the HACCP alarm area, press area  in the Home screen. The screen below will be displayed.

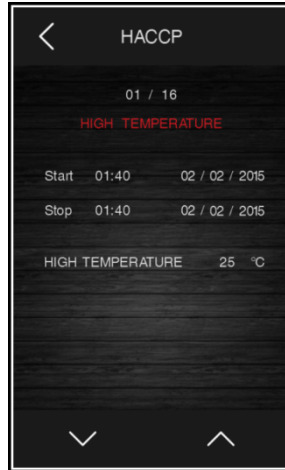

The following HACCP alarms are listed.

- Blast chilling/blast-freezing cycle duration
- Power failure
- Door open
- High temperature alarm
- Low temperature alarm

17 ACCESSORIES

17.1 EVIF25SWX - EVlink Wi-Fi module

Through the RS-485 communications port, it provides the controller with Wi-Fi connectivity which enables remote management and monitoring from the Internet using the EPoCA cloud system.



17.2 EVC20P52N9XXX10 - Multi-functional module

The module makes it possible to add to the controller's potential functions, enabling special cycles to be managed with control of heating and steam generation and injection.



17.3 ECTSFD004 - 230 VAC/12 VAC 20 VA safety transformer

The transformer can power the controller user interface.



17.4 EVIF20SUXI - Non-optoisolated RS-485/USB serial interface

The interface enables the controller to be connected to the Parameters Manager set-up software system.



17.5 0812000002 - USB plug for panel installation

This plug makes the controller's USB port more accessible.

To connect the plug to the USB port, connecting cable 0810500018 or 0810500020 must be used (to be ordered separately).



17.6 0810500018/0810500020 - Connecting cables

These cables are used to connect the USB plug for panel installation 0812000002 to the controller's USB port.

Cable 0810500018 is 2 m long; cable 0810500020 is 0.5 m long.



17.7 EVDFAN1 - Phase cutting speed regulator for single-phase fans

The regulator can vary the evaporator fan speed, to manage the blast chilling intensity.
The maximum operating current is 5 A.



17.8 EVUSB4096M - 4GB USB flash drive

This flash drive makes it possible to upload and download the controller configuration and the customized cycles saved by the user. HACCP data can also be exported in CSV format.



18 TECHNICAL SPECIFICATIONS

18.1 Technical specifications

Purpose of the control device	Function controller.		
Construction of the control device	Built-in electronic device.		
Container	user interface	control module	
	Open frame board behind glass.	Open frame board.	
Category of heat and fire resistance	D.		
Measurements	M user interface (horizontal format)	L user interface (horizontal format)	control module
	Flush-fit installation: 166,0 x 118,0 x 35,0 mm (6,535 x 4,645 x 1,377 in; L x H x D). Frontal installation: 145,1 x 97,1 x 32,0 mm (5.712 x 3.822 x 1.259 in; L x H x D).	Flush-fit installation: 216,0 x 156,0 x 50,0 mm (8,503 x 6,141 x 1,968 in; L x H x D). Frontal installation: 192,9 x 131,9 x 47,0 mm (7.594 x 5.192 x 1.850 in; L x H x D).	166.0 x 116.0 x 44.0 mm (6.535 x 4.566 x 1.732 in; L x H x D).
Mounting methods for the control device	user interface	control module	
	Flush with the panel from behind with threaded studs (not provided) to hold it in place or semi-recessed from the front of the panel using the spring clips	On a flat surface with spacers.	
Degree of protection	user interface	control module	
	IP65 (front).	IP00.	
Connection methodjgv y96	user interface	control module	
	Plug-in screw terminal blocks for wires up to 1.5 mm ² , type A female USB connector.	Plug-in screw terminal blocks for wires up to 2.5 mm ² .	

	Maximum permitted length for connecting cablesy - user-interface-control module connection: 10 m (32.8 ft) - power supply: 10 m (32.8 ft) - analogue inputs: 10 m (32.8 ft) - digital inputs: 10 m (32.8 ft) - analogue outputs: 1 m (3.28 ft) - digital outputs: 100 m (328 ft) - RS-485 MODBUS port: 1,000 m (3,280 ft) - USB port: 1 m (3.28 ft).	
Operating temperature	From 0 to 55 °C (from 32 to 131 °F)	
Storage temperature	From -10 to 70 °C (from 14 to 158 °F)	
Operating humidity	Relative humidity without condensate from 10 to 90%.	
Pollution status of the control device	2.	
Environmental standards	- RoHS 2011/65/EC - WEEE 2012/19/EU - REACH (EC) Regulation no. 1907/2006.	
EMC standards	- EN 60730-1 - IEC 60730-1.	
Power supply	user interface	control module
	Vcolor 819M: Powered by the control module. Vcolor 819L: 12 VAC ($\pm 15\%$), 50/60 Hz (± 3 Hz), max. 10 VA.	115... 230 VAC ($\pm 15\%$), 50/60 Hz (± 3 Hz), 10 VA max.
Rated impulse-withstand voltage	4 KV.	
Over-voltage category	III.	
Software class and structure	A.	
Clock	Built-in (with secondary lithium battery).	
	Clock drift: ≤ 60 s/month at 25 °C (77 °F).	
	Clock battery autonomy in the absence of a power supply: > 6 months at 25 °C (77 °F).	
	Clock battery charging time: 24 h (the battery is charged by the power supply of the device).	
Analogue inputs	6 for PTC or NTC probes (cabinet probe, needle probe with up to 3 sensors, evaporator probe and condenser probe).	
	<i>PTC probes</i>	
	Sensor type:	KTY 81-121 (990 Ω @ 25 °C, 77 °F).
	Measurement field:	from -50 to 150 °C (from -58 to 302 °F).
	Resolution:	1 °C (1 °F).

	<p><i>NTC probes</i></p> <p>Sensor type: 83435 (10 KΩ @ 25 °C, 77 °F).</p> <p>Measurement field: from -40 to 105 °C (from -40 to 221 °F)</p> <p>Resolution: 1 °C (1 °F).</p>
Digital inputs	<p>4, dry contact (door switch, compressor thermal switch, low and high pressure switch).</p> <p><i>Dry contact</i></p> <p>Contact type: 5 VDC, 2 mA.</p> <p>Power feed: none.</p>
Analogue outputs	<p>1 for PWM signal (for phase cutting speed regulator for single-phase EVDFAN1 fans).</p>
Digital outputs	<p>9, electro-mechanical relays (compressor, defrosting, evaporator fan, condenser fan, door heaters, thawing heaters, auxiliary 1, auxiliary 2 and auxiliary 3).</p> <p>The maximum permitted current on loads 3 and 4 is 10 A, on load K1 is 20 A (see the electrical circuit diagram). The relays do not manage LED and fluorescent lamps</p> <p>Compressor relay: 30 A SPST res. @ 250 VAC.</p> <p>Defrost relay: 8 A SPST res. @ 250 VAC.</p> <p>Evaporator fan relay: 8 A SPST res. @ 250 VAC.</p> <p>Condenser fan relay: 8 A SPST res. @ 250 VAC.</p> <p>Door heater relay: 8 A SPDT res. @ 250 VAC.</p> <p>Door heater relay: 16 A SPST res. @ 250 VAC.</p> <p>Auxiliary relay 1: 16 A SPST res. @ 250 VAC.</p> <p>Auxiliary relay 2: 8 A SPST res. @ 250 VAC.</p> <p>Auxiliary relay 3: 8 A SPST res. @ 250 VAC.</p>
Type 1 or Type 2 Actions	Type 1.
Additional features of Type 1 or Type 2 actions	C.
Displays	<p>7 or 5-inch capacitive TFT touch-screen graphic display, 65K colours, 800 x 480 pixel resolution. The presence of point defects on the display falls within the tolerance limits as provided by applicable standards.</p>
Alarm buzzer	Built-in.
Communications ports	<ul style="list-style-type: none"> - 1 RS-485 MODBUS port - 1 USB port

Vcolor 819/829

Controller for top-class blast chillers, with colour TFT touch-screen graphic display, in split version that can be built into the unit

Installer manual ver. 5.0

PT - 18/21

Code 144VC819E504

This document is the exclusive property of EVCO and any reproduction or disclosure is absolutely prohibited unless expressly authorised by EVCO.

EVCO accepts no liability for the features and technical data described in this document and for any errors it may contain or that can arise from its use.

EVCO may not be held liable for any damage caused by failure to follow the instructions described in this document.

EVCO reserves the right to make any modifications to this document without prior warning and at any time, without prejudice to the essential aspects of functionality and safety.



EVCO S.p.A.

Via Feltre 81, 32036 Sedico Belluno ITALY

Tel. 0437 / 8422

Fax 0437 / 83648

info@evco.it

www.evco.it