



Applications



Laboratory cabinets

Vcolor 279

Application Manual

Controller for laboratory cabinets



IMPORTANT

Read this document carefully before installation and take all precautions before using the device.
Only use the device in the ways described in this document.



CONSIDER THE ENVIRONMENT

Keep this document with the device for future reference.



DISPOSAL

The device must be disposed of according to local regulations governing the collection of electrical and electronic equipment.

Indice

Introduction	6
Vcolor 279 solution	7
Backup module	7
I/O expansion	7
EVlink Wi-Fi module	7
Possible configurations	7
Main features and purchasing codes of the controller	8
Vcolor 279 M&L	8
Main features and purchasing codes of the optional modules	9
Backup module	9
I/O expansion	9
EVlink Wi-Fi RS-485	9
Measurements	10
Vcolor 279 M user interface	10
Vcolor 279 L user interface	10
Control module	11
Backup module	11
I/O expansion	11
Installation	12
Vcolor 279 M/L user interface	13
Control module	13
Backup module	14
I/O expansion	14
Electrical connections	15
Vcolor 279 M user interface	16
Description of connectors	16
Electrical connection	16
User interface - Vcolor 279 L	17
Description of connectors	17
Electrical connection	17
Control module	18
Description of connectors	18
Electrical connection	19
EVlink Wi-Fi module	19
Electrical connection	19
Backup module	20
Description of connectors	20
Electrical connection	20

I/O expansion	21
Description of connectors	21
Electrical connection	21
Vcolor 279 M	22
Electrical connection	22
Vcolor 279 L	23
Electrical connection	23
 Description of graphic interface	24
Regulator status icons	24
Function keys	24
Main menu icons	25
Historical data icons	25
Service icons	26
Advanced functions icons	26
 Navigation	27
Splash screen	27
Stand-by screen	27
Log-in screen	27
Main screen	27
Preferences settings screen	27
Main menu	28
Graph screen	36
 Configuring inputs/outputs	37
Configuring temperature probes	37
Configuring digital outputs	37
Configuring digital inputs	38
Configuring the power meter input	38
 Regulations	39
Compressor management	39
Evaporator fan management	39
Condenser fan management	40
Door frame heater management	40
Alarm output management	40
ON/stand-by output management	41
Light management	41
Door lock management	41
Defrost management	41
Operating mode: "defrost"	42
Operating mode: "energy saving"	42

USB port management	43
EPoCA cloud platform	43
Alarms	44
Table of alarms	44
List of parameters	48
Accessories	55
Connecting cables	55
USB flash drive	55
RS-485/USB serial interface	55
Safety transformer	55
USB plug for panel installation	56
4 relay I/O expansion	56
Backup module	56
EVlink Wi-Fi RS-485 module	56
Technical specifications	57
User interface - Control module	57

Introduction

Vcolor 279 is a controller for refrigerated units and has 9 sealed relays (which can be expanded to 13) to meet the most sophisticated management needs in sectors such as laboratory refrigeration.

Regulation and reading accuracy is guaranteed by 3-point probe calibration and access to controller functions is hierarchically subject to user identification to increase the level of protection.

The controller interacts with a backup module to manage emergencies, ensuring that temperature readings are always recorded in the built-in data-logger, even in the event of a power failure.

Featuring intuitive navigation with real-time trend graphs, the controller's innovative programmable platform allows the user to personalise the graphic skin and add new machine interface languages.

Upon request, the controller can also be equipped with Wi-Fi connectivity so it can interact remotely with the unit through the EPoCA® cloud platform.

Available in a 5- or 7-inch split version with a capacitive colour TFT touch-screen graphic display, the user interface can be installed recessed from the front or flush with the panel thus making it fit perfectly with the design of the unit.



Vcolor 279 solution

The Vcolor 279 is available in the split version with a control module combined with a 5-inch (Vcolor 279 M) or 7-inch (Vcolor 279 L) user interface.

This basic configuration can be connected to a series of optional modules illustrated below, increasing its functions and making Vcolor 279 a complete control solution that can be customised to everyone's needs.

Backup module

The backup module can be connected to the RS-485 network and must be equipped with a backup battery of the user's choice. It gathers information about:

Backup battery status:

- if a backup battery is installed or not and if it is faulty

Mains and module voltage status:

- information about the real-time status of the mains voltage
- no mains voltage alarm

Reading of the product probe (acts as a backup in the event of a power failure to the controller) that can be connected to the module:

- information about the value detected by the Pt1000 probe

I/O expansion

The I/O expansion can be connected to the RS-485 network and has 4 fully configurable digital outputs. It enables the user to control 4 more loads, compared to the 9 available on Vcolor 279.

EVlink Wi-Fi module

EVlink Wi-Fi is a hardware module with built-in Wi-Fi connectivity that can be connected to the RS-485 port of the user interface to enable remote management and monitoring through the Internet using the EPoCA system.

Possible configurations

- **Basic configuration**
 - User interface
 - Control module
 - Safety transformer (to power the 7-inch user interface)
- **+ Backup module**
 - User interface
 - Control module
 - Backup module (also powers the user interface)
- **+ I/O expansion**
 - User interface
 - Control module
 - I/O expansion
 - Safety transformer (to power the 7-inch user interface)
- **+ Backup module, + I/O expansion**
 - User interface
 - Control module
 - Backup module (also powers the user interface)
 - I/O expansion
- **+ EVlink Wi-Fi**
 - User interface
 - Control module
 - EVlink Wi-Fi
 - (Backup module)
 - (I/O expansion)

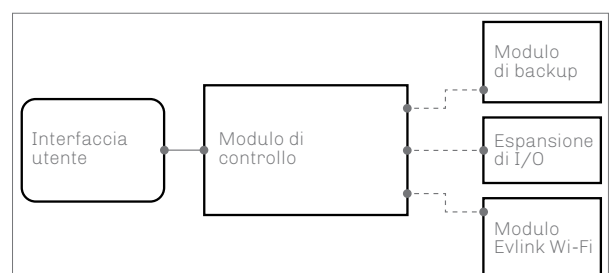

Main features and purchasing codes of the controller

Vcolor 279 M&L

Vcolor 279	Vcolor 279 M	Vcolor 279 L
Interface format		
Capacitive TFT touch-screen graphic display in glass	5 inch (M)	7 inch (L)
Power supply		
User interface	From the control module or backup module	From the backup module
Control module	115... 230 VAC	115... 230 VAC
Analogue inputs (PT1000 2 wires)		
Probe 1 configurable (default cabinet probe)	•	•
Probe 2 configurable (default evaporation probe)	•	•
Probe 3 configurable (default condenser probe)	•	•
Other inputs		
Power meter (connected via RS-485 MODBUS)	•	•
Digital inputs (for NO/NC contact)		
Door switch	•	•
Multi-purpose 1 configurable (default low pressure switch)	•	•
Multi-purpose 2 configurable (default high pressure switch)	•	•
Multi-purpose 3 configurable (default compressor thermal switch)	•	•
Digital outputs (sealed electro-mechanical relays, res. at 250 VAC)		
K1 configurable (default compressor)	16 A	16 A
K2 configurable (default cabinet light)	8 A	8 A
K3 configurable (default condenser fans)	8 A	8 A
K4 configurable (default evaporator fans)	8 A	8 A
K5 configurable (default alarm)	8 A	8 A
K6 configurable (default electronic door lock)	16 A	16 A
K7 configurable (default battery testing)	16 A	16 A
K8 configurable (default door heaters)	10 A	10 A
K9 configurable (default defrost)	10 A	10 A
Communications ports		
RS-485 MODBUS	1	1
USB	1	1
Further features		
Clock	•	•
Alarm buzzer	•	•

The series includes the following purchasing codes:

Vcolor 279M (5"):

- EVCMC279Z9E: flush-fit installation
- EVCMC279Z9EF: frontal installation

Vcolor 279L (7"):

- EVCLC279Z9E: flush-fit installation
- EVCLC279Z9EF: frontal installation

Main features and purchasing codes of the optional modules

Backup module	EVPS9B
Power supply	
115... 230 VAC	•
Analogue inputs (PT1000 2 wires)	•
Probe 4 configurable (default product probe)	•
Digital outputs (electro-mechanical relays, A res. at 250 VAC)	
K14 configurable (default CO ₂ backup)	8 A
Communications ports	
RS-485 MODBUS	1
Further features	
Clock	•
Alarm buzzer	•

I/O expansion	EVC20P52N9XXX10
Power supply	
115... 230 VAC	•
Digital outputs (electro-mechanical relays, res. at 250 VAC)	
K10 configurable	30 A
K11 configurable	16 A
K12 configurable	8 A
K13 configurable	16 A
Communications ports	
RS-485 MODBUS	1

EVlink Wi-Fi RS-485	EVIF25SWX
Power supply	
12 VAC/15 VDC	•
Communications ports	
RS-485 MODBUS	•
Other features	
Clock	•
Wi-Fi connectivity	•

Measurements

Vcolor 279 M user interface

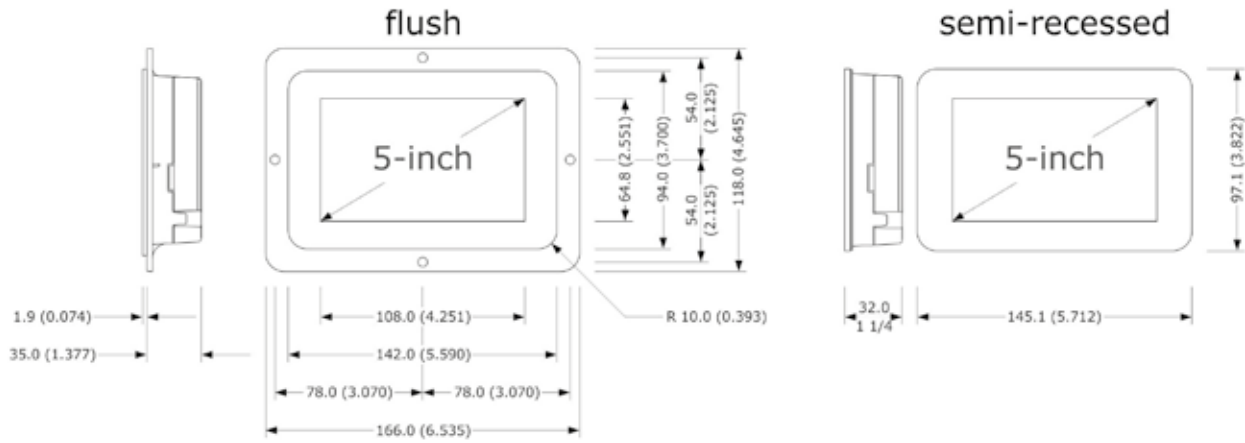

Vcolor 279 L user interface

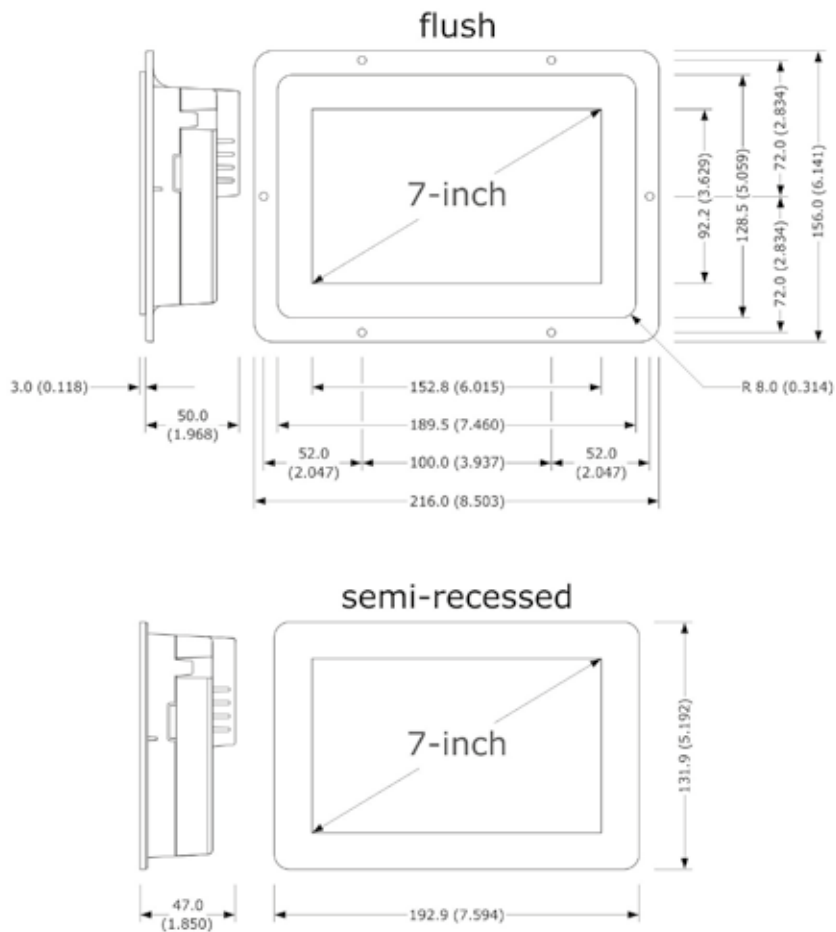

Control module

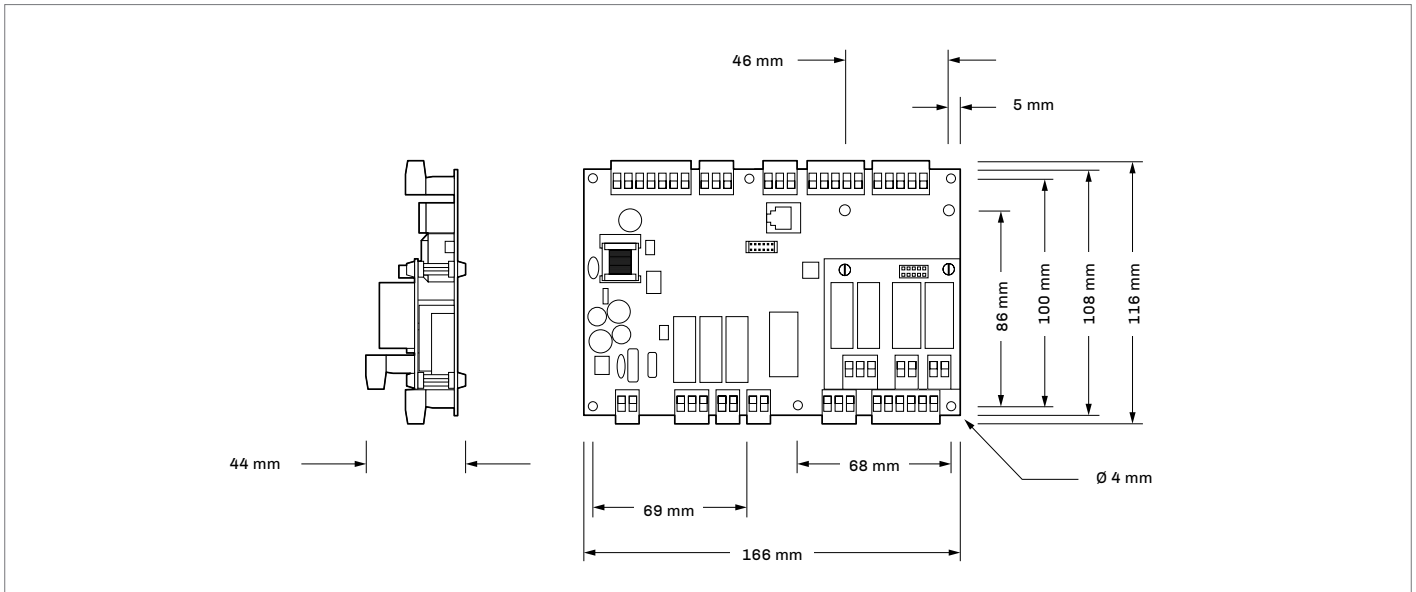

Backup module

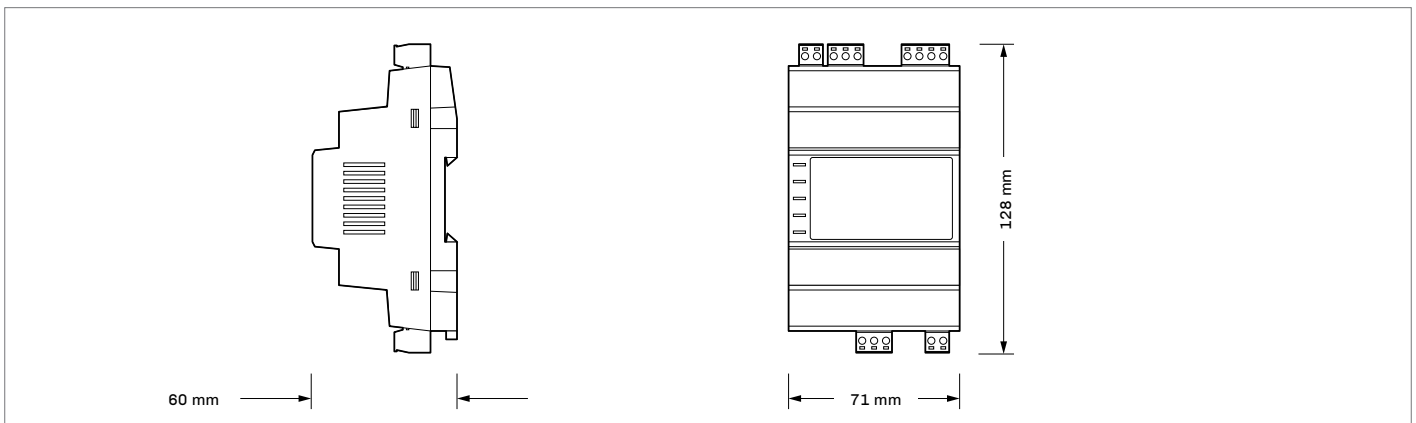

I/O expansion

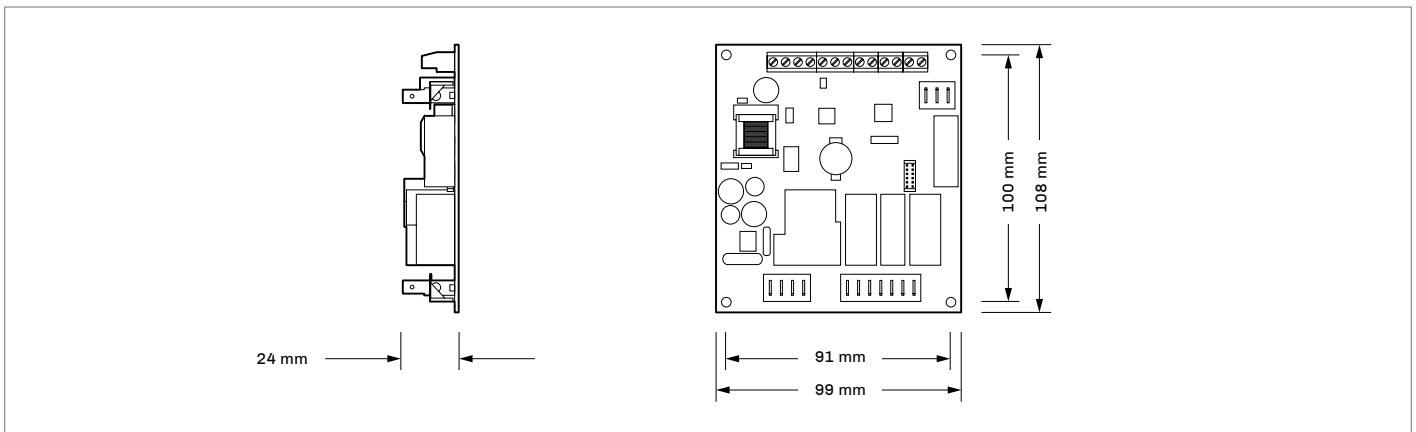

Installation



INSTALLATION PRECAUTIONS

- Ensure that the working conditions are within the limits stated in the "*Technical specifications*" section.
- Do not install the device close to heat sources, equipment with a strong magnetic field, in places subject to direct sunlight, rain, damp, excessive dust, mechanical vibrations or shocks.
- In compliance with safety regulations, the device must be installed properly to ensure adequate protection from contact with electrical parts. All protective parts must be fixed in such a way as to need the aid of a tool to remove them.

Vcolor 279 M/L user interface

Depending on the model, installation can be:

- flush, from behind the panel with threaded studs (not provided) welded to hold it in place;
- semi-recessed, from the front of the panel with spring clips to hold it in place.

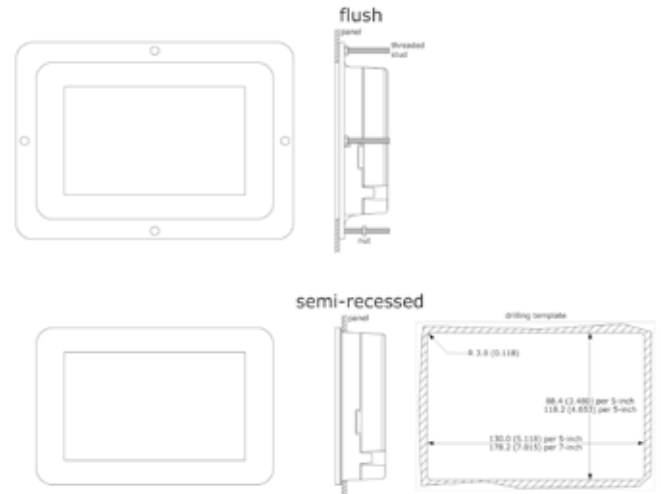

Control module

The control module is installed on a flat surface with spacers (not provided).

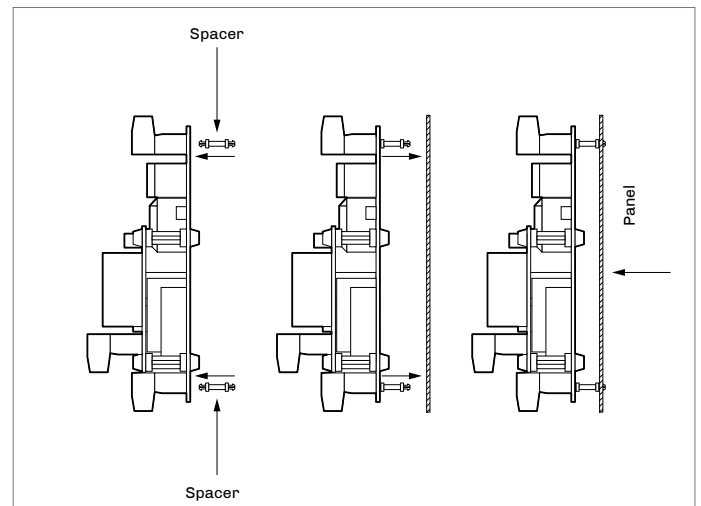

Backup module

The backup module is installed on a DIN rail.

To install the device, proceed as shown in figures 1 and 2.

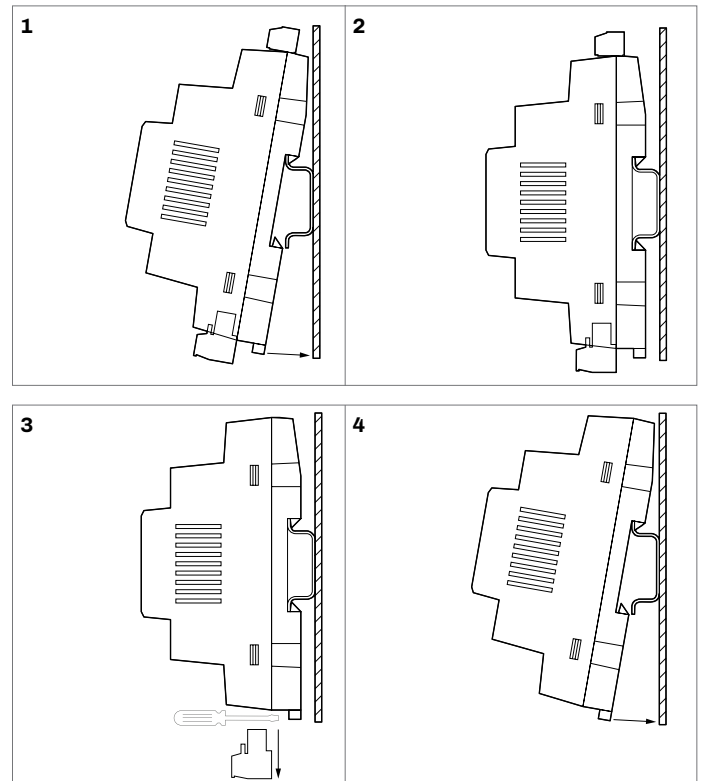

To remove the device, first remove any plug-in screw terminal blocks at the bottom then proceed as shown in figures 3 and 4.

I/O expansion

The I/O expansion is installed on a flat surface with spacers (not provided).

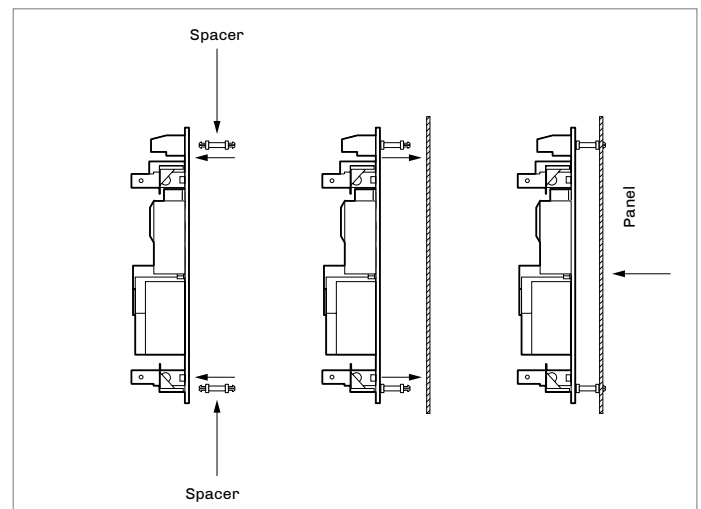

Electrical connections



PRECAUTIONS FOR ELECTRICAL CONNECTIONS

- Use cables of an adequate section for the current running through them
- To reduce any electromagnetic interference, connect the power cables as far away as possible from the signal cables and connect to a RS-485 MODBUS network using a twisted pair
- If using an electrical or pneumatic screwdriver, adjust the tightening torque
- If the device is moved from a cold to a warm place, humidity may cause condensation to form inside; wait for about an hour before switching on the power
- Make sure that the supply voltage, electrical frequency and power are within the set limits
- Disconnect the power supply before carrying out any type of maintenance
- Do not use the device as a safety device
- For repairs and further information, contact the EVCO sales network; returned goods without the data label will not be accepted

Average consumption in conditions of power failure

- Vcolor M powered at 12 VDC from EVPS9B powered at 12 VDC from the backup battery: 0,17 A
- Vcolor L powered at 12 VDC from EVPS9B powered at 12 VDC from the backup battery: 0,33 A

Add 0.035 A if the EVlink Wi-Fi module is connected.

Vcolor 279 M user interface

Description of connectors

Connector 1 - USB

Number	Description
	USB communications port

Connector 2 - RS-485 MODBUS port

Number	Description
32	Signal A (+) RS-485 MODBUS port
31	Signal B (-) RS-485 MODBUS port
30	Shield

Connector 3 - Device network

Number	Description
33	+
34	A+
35	B-
36	-

Connector 4 - Earthing

Number	Description
PE	Device earthing
PE	Device earthing

Micro-switch

Number	Description
2	Dip switch for the termination resistor of the RS-485 MODBUS port
1	Dip switch for the termination resistor of the user interface

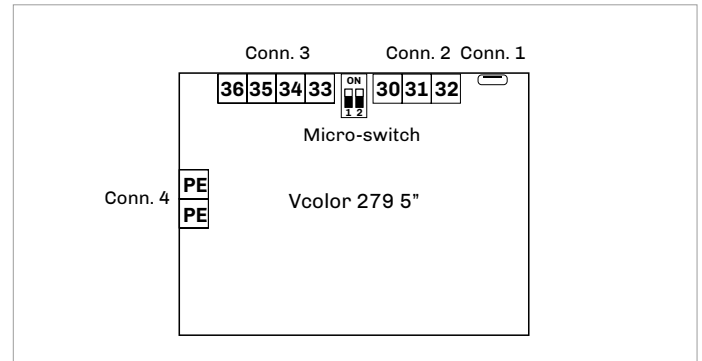

Electrical connection

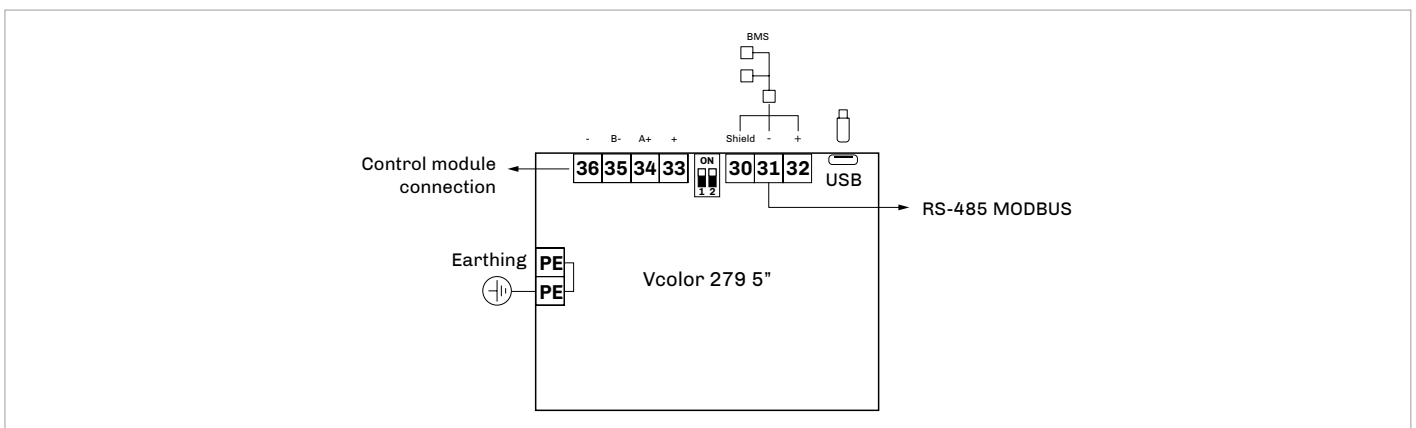

Vcolor 279 - Application manual

User interface - Vcolor 279 L

Description of connectors

Connector 1 - USB

Number	Description
	USB communications port

Connector 2 - RS-485 MODBUS port

Number	Description
32	Signal A (+) RS-485 MODBUS port
31	Signal B (-) RS-485 MODBUS port
30	Shield

Connector 3 - Device network

Number	Description
33	-
34	B-
35	A+
36	+

Connector 4 - Earthing

Number	Description
PE	Device earthing
PE	Device earthing

Micro-switch

Number	Description
2	Dip switch for the termination resistor of the RS-485 MODBUS port
1	Dip switch for the termination resistor of the user interface

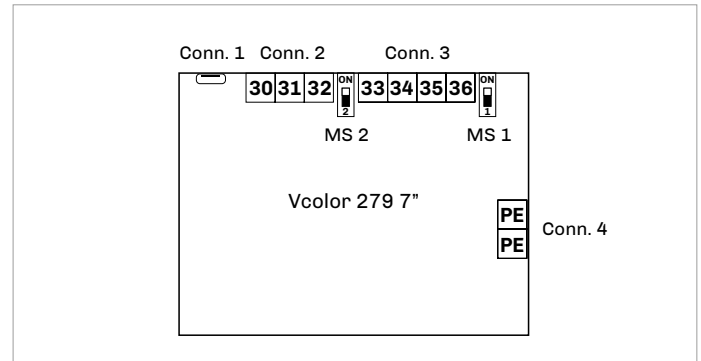

Electrical connection

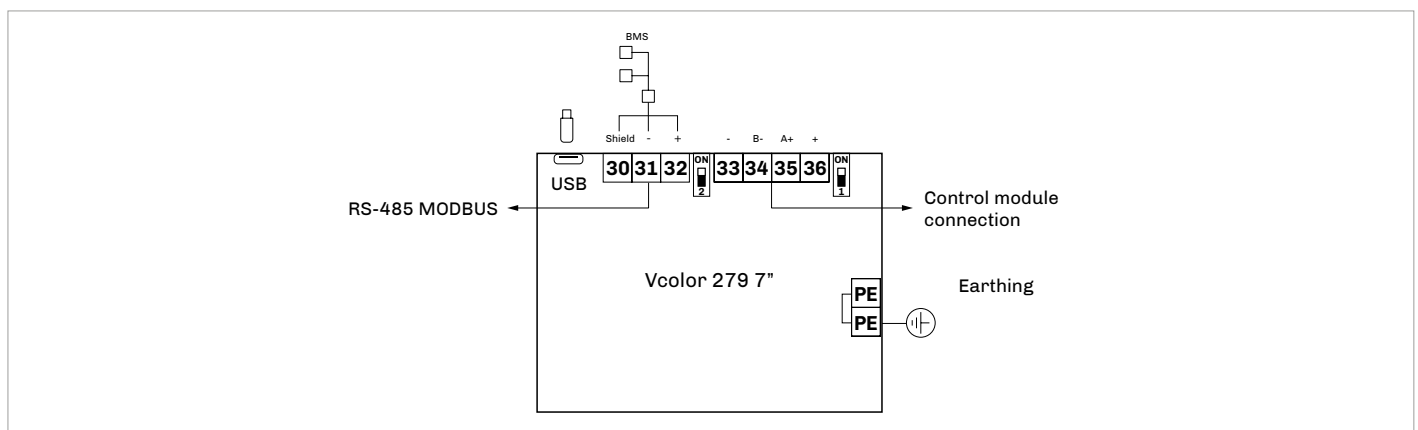

Control module

Description of connectors

Connector 1 - Power supply

Number	Description
1	Power supply 115... 230 VAC
2	Power supply 115... 230 VAC

Connector 2 - Relay K4/K3

Number	Description
4	Relay K4/K3 common contact
5	Relay K4 normally open contact
6	Relay K3 normally open contact

Connector 3 - Relay K2

Number	Description
7	Relay K2 common contact
8	Relay K2 normally open contact

Connector 4 - Relay K1

Number	Description
9	Relay K1 common contact
10	Relay K1 normally open contact

Connector 5 - Relay K5

Number	Description
11	Relay K5 common contact
12	Relay K5 normally open contact
13	Relay K5 normally closed contact

Connector 6 - Digital inputs

Number	Description
14	Digital inputs common contact
15	Door switch normally open contact
16	Low pressure normally open contact
17	Digital inputs common contact
18	High pressure normally open contact
19	Thermal switch normally open contact

Connector 7 - Relay K9/K8

Number	Description
1	Relay K9/K8 common contact
2	Relay K9 normally open contact
3	Relay K8 normally open contact

Connector 8 - Relay K7

Number	Description
4	Relay K7 common contact
5	Relay K7 normally open contact

Connector 9 - Relay K6

Number	Description
6	Relay K6 common contact
7	Relay K6 normally open contact

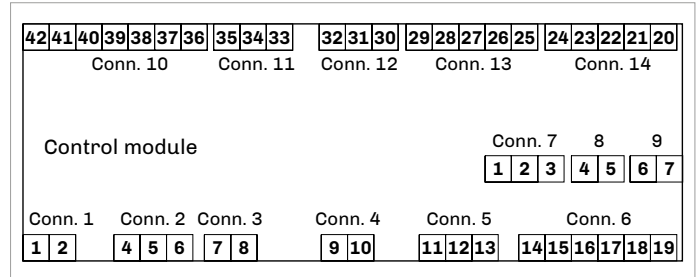

Connector 10 - Device network

Number	Description
42	Unused
41	Unused
40	Unused
39	Unused
38	B-
37	A+
36	Unused

Connector 11 - Unused

Number	Description
35	Unused
34	Unused
33	Unused

Connector 12 - Unused

Number	Description
32	Unused
31	Unused
30	Unused

Connector 13 - Unused

Number	Description
29	Unused
28	Unused
27	Unused
26	Unused
25	Unused

Connector 14 - Probes

Number	Description
24	Unused
23	Probe 1
22	Probe 2
21	Probe 3
20	Unused

Electrical connection

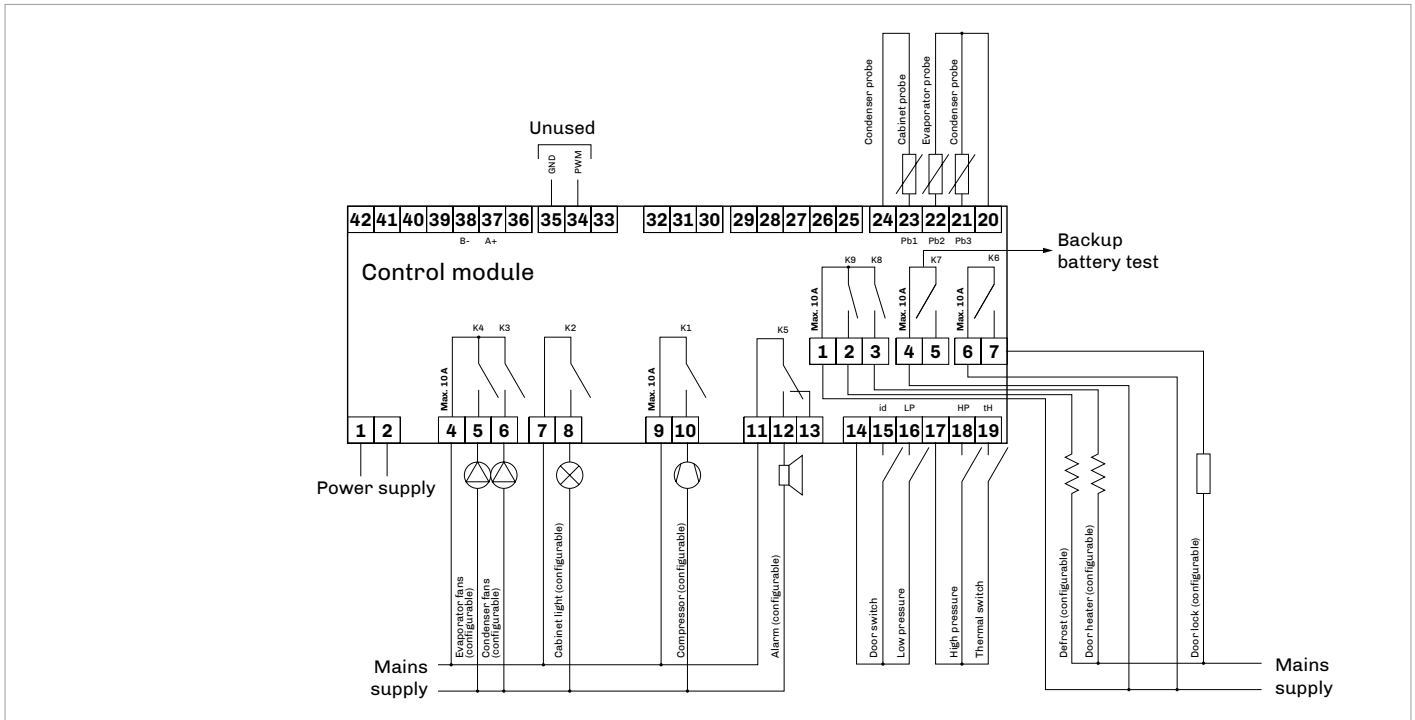

EVlink Wi-Fi module

Electrical connection

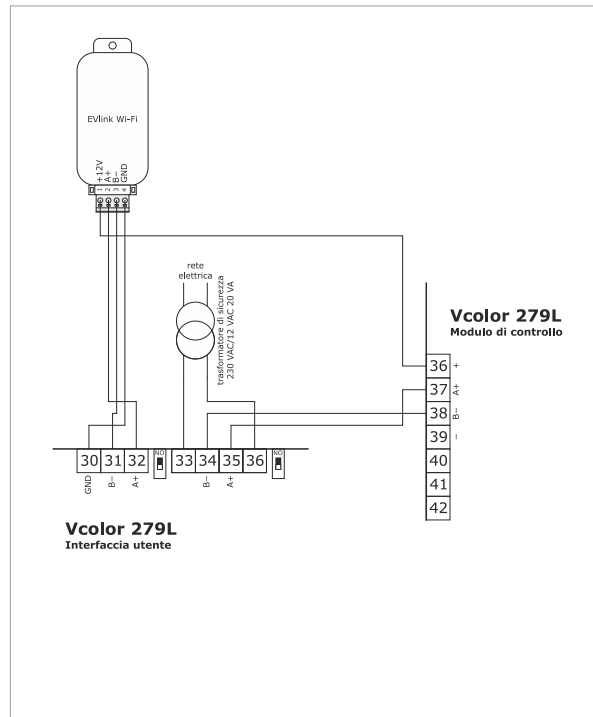
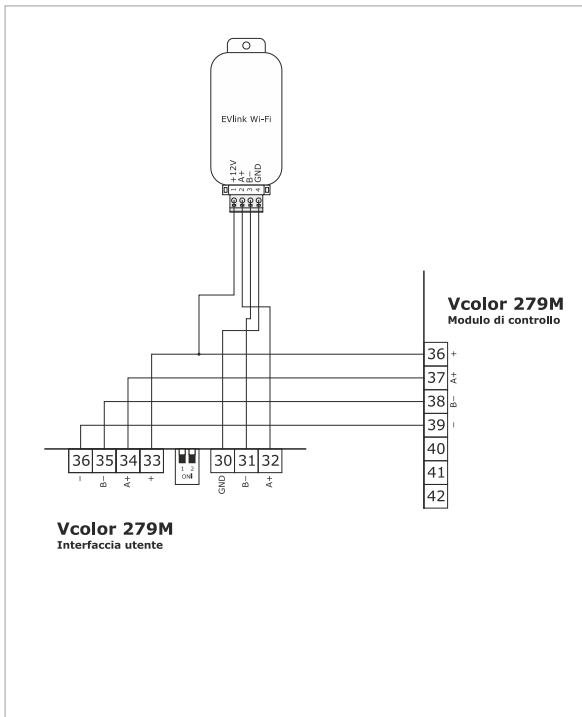

Backup module

Description of connectors

Connector 1 - Probe 4

Number	Description
11	Probe 4 common contact
12	Probe 4

Connector 2 - Device network

Number	Description
13	Signal A (+) RS-485 MODBUS port
14	Signal B (-) RS-485 MODBUS port
15	Shield

Connector 3 - Backup battery

Number	Description
16	V+
17	V-
18	VOUT
19	GND

Connector 4 - Relay K14

Number	Description
1	Relay K14 common contact
2	Relay K14 normally open contact
3	Relay K14 normally closed contact

Connector 5 - Power supply

Number	Description
4	Power supply 115... 230 VAC
5	Power supply 115... 230 VAC

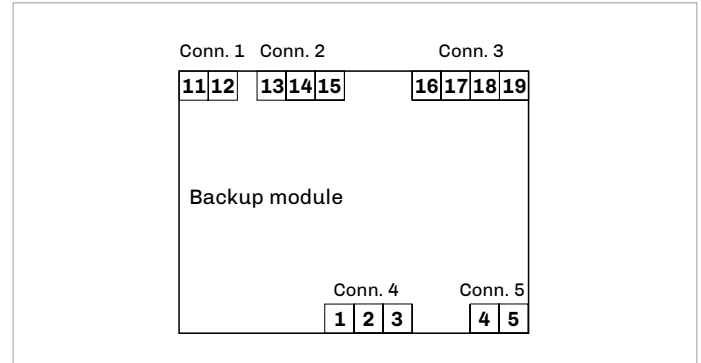

Electrical connection

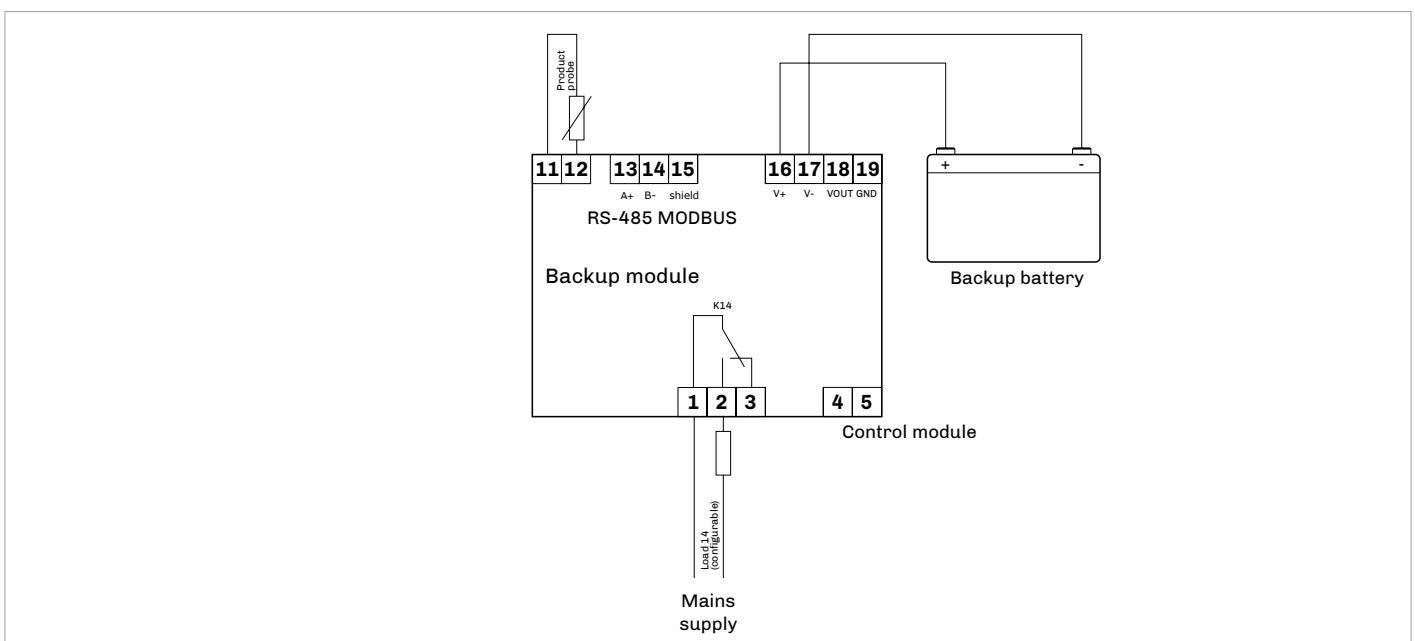

I/O expansion

Description of connectors

Connector 1 - Device network

Number	Description
27	Unused
26	Signal B (-) RS-485 MODBUS port
25	Signal A (+) RS-485 MODBUS port
24	Unused
23	Unused
22	Unused
21	Unused
20	Unused
19	Unused
18	Unused
17	Unused
16	Unused
15	Unused

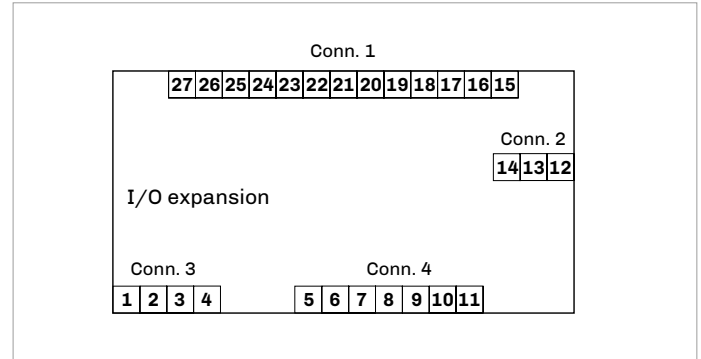

Connector 2 - Unused

Number	Description
14	Unused
13	Unused
12	Unused

Connector 4 - Relay K11/K12/K13

Number	Description
5	Relay K10/ K11/ K12 common contact
6	Relay K11 normally open contact
7	Relay K10/ K11/ K12 common contact
8	Relay K12 normally open contact
9	Relay K10/ K11/ K12 common contact
10	Relay K13 normally open contact
11	Relay K13 normally closed contact

Connector 3 - Relay K10 / Power supply

Number	Description
1	Relay K10/ K11/ K12 common contact
2	Relay K10 normally open contact
3	Power supply 115... 230 VAC
4	Power supply 115... 230 VAC

Electrical connection

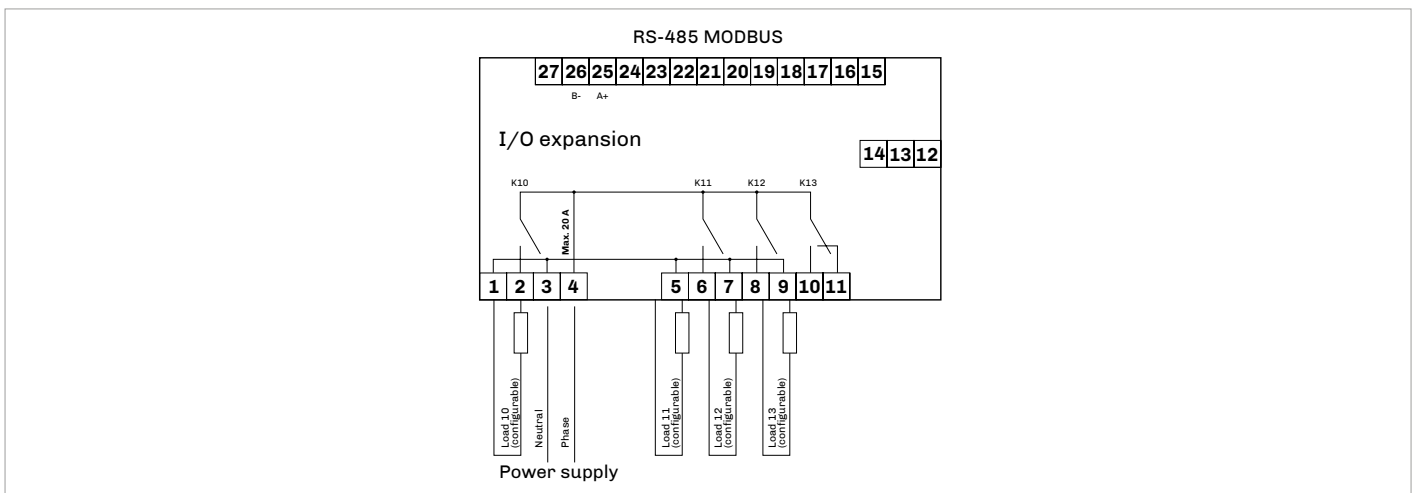

Vcolor 279 - Application manual

Vcolor 279 M

Electrical connection

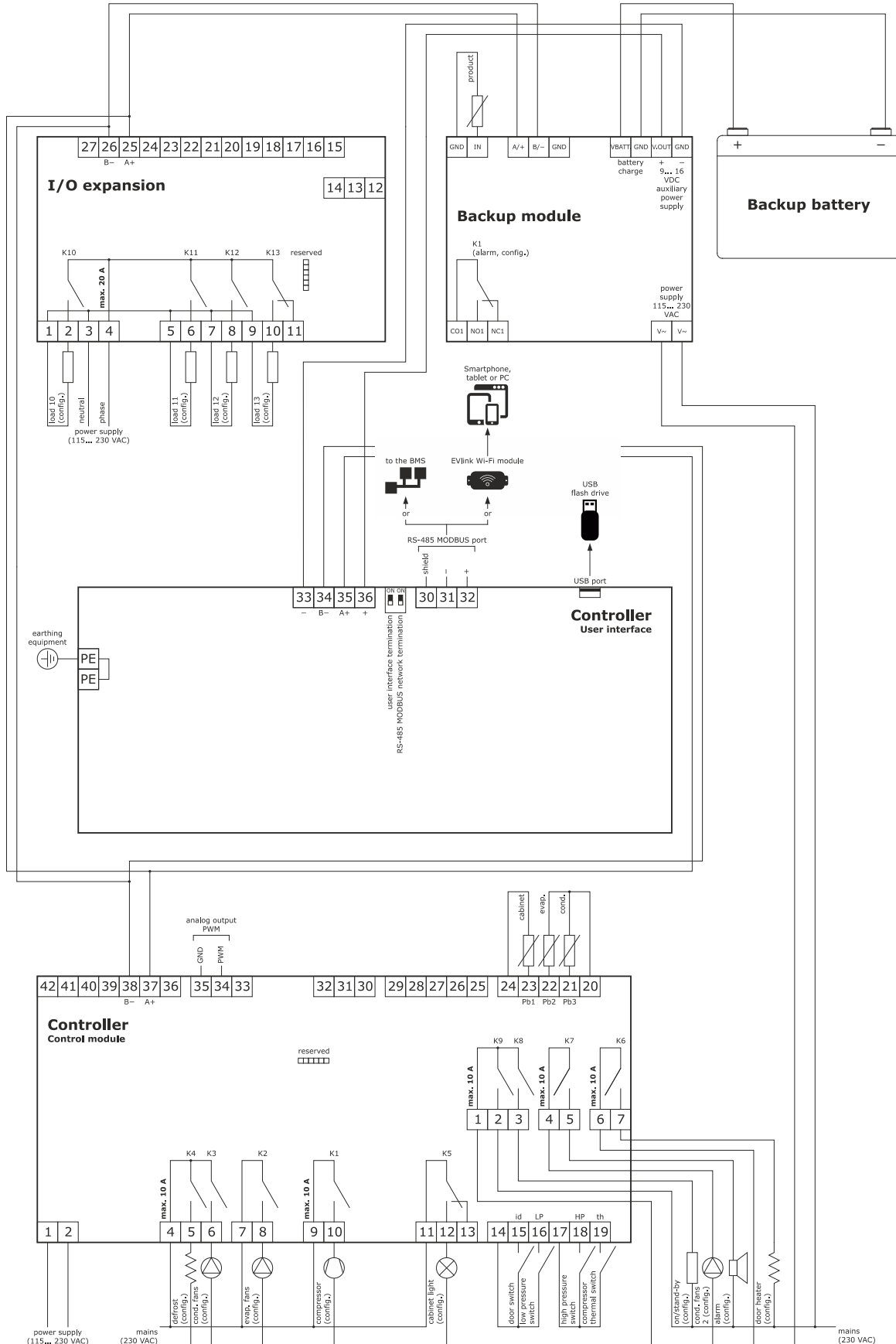

Vcolor 279 - Application manual

Vcolor 279 L

Electrical connection

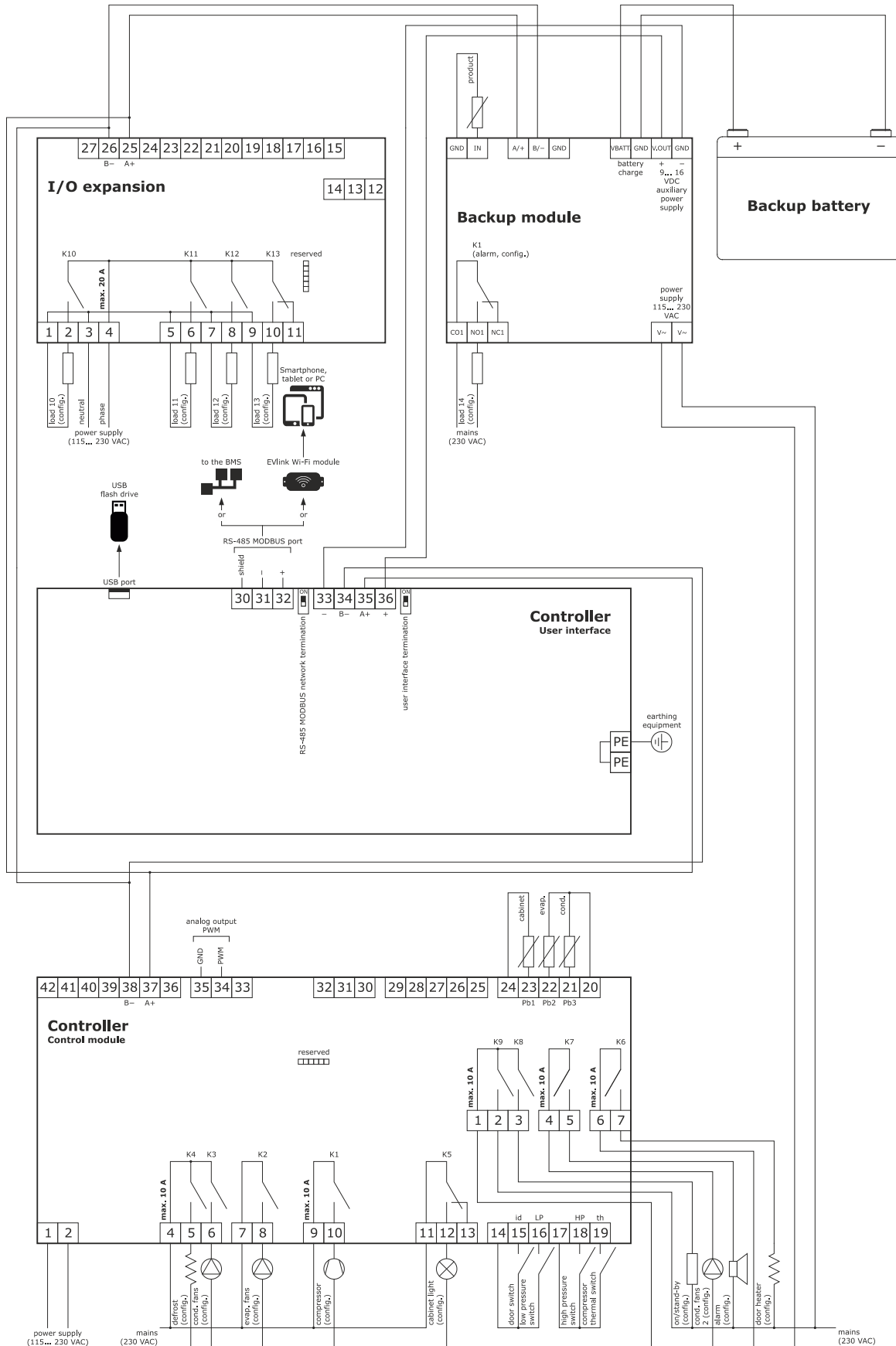







Description of graphic interface

Regulator status icons





During machine operation, the status of the main regulators is displayed through the icons at the top of the screen.



-  Compressor 1 active
-  Compressor 2 active
-  Evaporator fans working
-  Defrosting in progress
-  Dehumidification active
-  Wi-Fi connection active
-  Battery level

Function keys

During machine operation, a number of functions, if available, can be activated using the keys at the bottom of the screen.











-  Light switched on and off (if parameter "u2 = 1")
-  Access to main menu
-  Access to graphic display in real time
-  Machine off



Main menu icons

The icons in the main menu are used to select the machine's functions. They are displayed in the centre of the screen by pressing the "MAIN MENU"  key.



-  Adjust working setpoint
-  Select manual defrost
-  Battery status
-  Lock/unlock lock
-  Manage historical data
-  Set temperature alarms
-  Manage levels and enable users
-  Change language
-  Select service menu
-  Select settings menu

Historical data icons

The icons in the historical data menu are used to consult and select recorded data, events and machine alarms. They are displayed in the "HISTORICAL DATA" menu. 



-  Alarm history
-  Defrost history
-  Door open history
-  Counter history
-  Delete history
-  Set up historical data

Service icons

The icons in the service menu are used to set basic machine functions and are displayed in the "SERVICE" menu

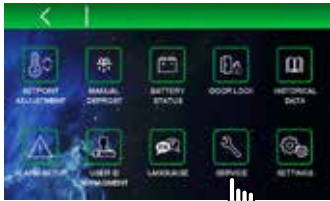

Advanced functions icons

The icons in the advanced functions menu are used to set the machine's advanced functions. They are displayed in the "ADVANCED FUNCTIONS" menu



Set date and time



Input and output status



List of alarms



Set unit name



Enable/disable welcome page



Advanced functions



3-point calibration of probes



Output testing

Navigation

Splash screen

When the device is powered up for the first time or after a power failure, a splash screen will appear for a couple of seconds: if E9=0, the EVCO logo will appear; if E9=1, a neutral loading screen or the personalised graphic skin (if uploaded) will appear. The display will then show the status the device was in before the power failure.



Stand-by screen

If the device was in stand-by at the time of the power failure, it will come back on in stand-by without showing any alarms that may have been set off.



Log-in screen

If, when the device is switched on, parameter E17 which enables users is set to 1, a stand-by screen will appear with an area at the bottom right for user log-in. After the credentials and the password have been inserted, the switch-on key is enabled.

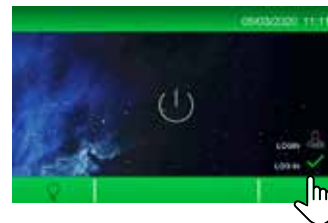

Main screen

When the device is switched on, the main operational screen will appear if the "WELCOME PAGE" function has not been activated (see the SERVICE section). This page will also be the "HOME" screen which the controller will return to after exiting certain sub-menus.

The number in the centre of the screen is the temperature of the probe which has been chosen as the main value when setting the parameters. The number at the bottom of the screen is the temperature of the probe which has been chosen as the secondary value when setting the parameters.



Preferences settings screen

When the device is switched on, a series of screens will appear if the "WELCOME PAGE" function has been activated (see the SERVICE section). These screens allow the user to quickly set the following preferences using a wizard:

- Language
- Name of unit (press the default name and use the keypad to enter a new name and then confirm it)
- Temperature measurement unit
- Temperature alarms and pre-alarms
- Backup module settings (if fitted and enabled)
-
- Enable or disable levels accessed by the "admin" user (only if parameter "E17=1"). For this procedure, consult the section USER ID MANAGEMENT.
- Checkbox which disables the wizard the next time the device is switched on.

After this procedure has been completed, the device switches off and then automatically comes back on again to make the settings effective.

Main menu



All the functions in the main menu are always available if parameter "E17=0", whereas if E17 = 1 they are only available to the "Admin" user or other users enabled to carry out the specific function. To enable users, consult the section "USER ID MANAGEMENT".



CHANGING THE SETPOINT

If users are enabled, they can change the working setpoint from the "CHANGE SETPOINT" menu using the slider at the bottom of the screen or the keys **+** and **-** (within the limits provided for by parameters "r1" and "r2").

Press the temperature reading in the middle of the screen to save the change and go back to the previous screen.

Press the left arrow **<** to exit the setting screen without saving any changes.



The setpoint setting can also be accessed from the "HOME" screen by pressing on the temperature reading.



MANUAL DEFROST

An immediate defrosting cycle can be activated from the "MANUAL DEFROST" menu (conditions permitting).



BATTERY STATUS

Battery status can be visualised from the "BATTERY STATUS" menu.

When the battery is working properly, the voltage supplied by the battery is displayed.

If there is no battery or the battery is not working properly, the message "Battery problems" will appear. If there are communication problems with the backup module, the message "Information unavailable" will appear.

The battery charge is also displayed at the top of the "HOME" screen.





DOOR LOCK

The door lock can be unlocked/locked from the "DOOR LOCK"  menu.



HISTORICAL DATA

Recorded data, events and machine alarms can be consulted from the "HISTORICAL DATA"  menu:

- "ALARM HISTORY"
- "DEFROST HISTORY"
- "DOOR HISTORY"
- "COUNTER HISTORY"



It is also possible to adjust the history using the following functions:

- "DELETE HISTORY"
- "SETUP HISTORICAL DATA"



ALARM HISTORY

A report of the latest 30 alarms can be visualised from the "ALARM HISTORY"  menu.

The following information is given:

- number of alarms recorded
- type of alarm
- start date/time and end date of alarm
- Tmax of the cabinet probe and product during the alarm

If no alarms are recorded, the message "No information" will appear.



DEFROST HISTORY

A report of the latest 30 defrosts can be visualised from the "DEFROST HISTORY"  menu.

The following information is given:

- number of defrosts recorded
- type of defrost
- start date/time and duration of defrost

If no defrosts are recorded, the message "No information" will appear.



DOOR HISTORY

A report of the door openings can be visualised from the "DOOR HISTORY"  menu.

The first screen displays the report for the current day, the following screens display the reports of the previous 30 days.

The following information is given:

- total number of door openings
- critical number of door openings (higher than the value of parameter "i2")
- total door open time



COUNTER HISTORY

A report of the machine operating times can be visualised from the "COUNTER HISTORY"  menu.

The following information is given:

- total hours machine was switched on (if the value is above 23:59 minutes, the number of days is displayed)
- total hours compressor was switched on (if the value is above 23:59 minutes, the number of days is displayed)
- average time compressor was switched on (in minutes)
- average time compressor was switched off (in minutes)
- average daily percentage machine was switched on
- percentage compressor was switched on in the last hour

When the operating time of the compressor is displayed, the  icon appears. This may be pressed to reset the operating hours of the compressor only and, as a result, to reset any compressor maintenance alarms.



DELETE HISTORY

Some or all of the stored data may be deleted from the "DELETE HISTORY"  menu.

By selecting one history and pressing the "OK"  key, it will be deleted.

By selecting "all stored historical data", all the data will be deleted.

When deleting the history, the password 4598 must be entered beforehand.



SETUP HISTORICAL DATA

Information to store in the history can be selected from the "SETUP HISTORICAL DATA" menu.

The following information can be selected:

page 1

- Temperature detected by the cabinet probe
- Temperature detected by the product probe
- Temperature detected by the evaporator probe
- Temperature detected by the condenser probe
- Temperature detected by the reference probe
- Temperature detected by the regulation probe
- Working setpoint

page 2

- Machine status (ON/OFF)
- User who logged in
- Action carried out by user who logged in
- Defrost status
- Door status
- Type of operating request in progress

From page 3 onwards

- All possible machine alarms.
This selection of data is used to compile the file "*.CSV" which can be downloaded onto a USB flash drive.



ALARM SETUP

The thresholds of the high and low cabinet and product temperature alarms and pre-alarms can be changed from the "ALARM SETUP" menu.

On the first screen it is possible to change the thresholds of the high and low cabinet temperature alarms and decide if they are absolute or relative to the working setpoint.

On the second screen it is possible to follow the same procedure for the thresholds of the high and low product temperature alarms.

These screens can be viewed by pressing the "UP" and "DOWN" keys on the bar at the bottom of the page.

The following settings will be displayed in sequence:

- cabinet temperature alarms
- product temperature alarms
- cabinet temperature pre-alarms
- product temperature pre-alarms

By pressing the "OK" key, the settings will be saved.



USER ID MANAGEMENT

Users need to access the application with a password. When the device is switched on, a stand-by screen will appear with an area at the bottom right if the enable users parameter "E17" is set to 1. To access the application, press the green "Login" tick and enter the password on the numerical keypad.



There are 9 different access logins:

- 8 which are completely configurable
- 1 "Admin" which has access to all the control functions. It can also configure the other 8 users.

The default "Admin" password is 0000 but it can be changed by accessing the USER ID MANAGEMENT menu as the "Admin" and pressing the icon at the top left.

There is also a "super password" in case the "Admin" password is forgotten. If this should happen, contact the EVCO sales network.

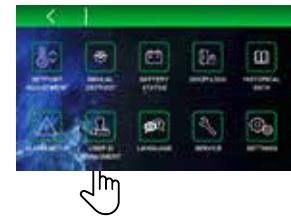

The "Admin" user can do the following on the first page of the USER ID MANAGEMENT menu:

- enable/disable users 1 to 6



On the following pages (one for each enabled user), the "Admin" user can:

- select the controller menus each user will have access to (the enabled menus will be in green, the disabled ones in grey)
- set and change each user's password



After logging in, the user may access all the functions available for that level.

After use, it is possible to log out:

- manually, pressing on the log out area
- automatically, after one minute of inactivity of the user interface





LANGUAGE

The language can be set from the "LANGUAGE" menu .
The languages available are:

- English
- Italian
- Spanish
- German
- French



SERVICE

The following information can be accessed from the "SERVICE" menu :



- DATE/TIME
- IN/OUT STATUS
- LIST OF ALARMS
- UNIT NAME
- WELCOME PAGE
- ADVANCED FUNCTIONS



DATE/TIME

The date and time on the controller can be set from the "DATE/TIME" menu .

This function can also be accessed from the "HOME" screen by pressing on the area where the date is displayed.

To change the date and time, press the related value and then press the  and  keys to set the desired value.

To save the value, press it again. Continue in this way for the other values.

Press the  key to confirm the date and time set.



IN/OUT STATUS

The status of all inputs and outputs on the board can be visualised on the "IN/OUT STATUS"  screen.



LIST OF ALARMS

All the active/deactivated alarms on the machine can be visualised on the "LIST OF ALARMS"  screen.



UNIT NAME

A name or serial number can be given to the installed until on the "UNIT NAME"  screen.

The name must be made up of a maximum of 10 characters and the serial number of a maximum of 10 numbers.

To change the name, press on the existing one and enter the new name on the key pad. The name will appear, confirm with the OK key.

The name and serial number are used to name the file "*.csv" which can be downloaded onto a USB flash drive.



WELCOME PAGE

By activating the “WELCOME PAGE” icon when the machine is switched on, it is possible to visualise a series of screens which enable the user to quickly set the controller preferences using a wizard (see the section “Preferences settings screen”).

By deactivating the “WELCOME PAGE” icon, the screens enabling the user to set the controller preferences will not be displayed the next time the device is switched on.



ADVANCED FUNCTIONS

The following functions can be set from the

“ADVANCED FUNCTIONS” screen:

- 3-point calibration of probes
- Output testing

The ID firmware of the electronic circuit boards connected can also be displayed.



3-POINT CALIBRATION

The “3-POINT CALIBRATION” function calibrates the cabinet probe and the product probe in three points, depending on the specific temperature range used by the machine.



OUTPUT TESTING

In the “OUTPUT TESTING” screen it is possible to

manually activate/deactivate one or more controller outputs independently of the temperature regulation in progress.

When temperature regulation is in progress, the **STOP** **START** icons allow the user to interrupt/resume temperature regulation of the machine, thus passing to manual control.

It is possible to switch each of the relay outputs on/off individually.

- The control module has K1 to K9 relays
- The I/O expansion (if connected) has K10 to K13 relays

By quitting the screen, regulation automatically resumes, even if it has not been restarted using the specific “START” **START** key.



SETTINGS

The page to configure parameters and the page to restore EVCO default values can be accessed from the "SETTINGS"  menu.







SETTING PARAMETERS

Press "SET PARAMETERS" **IMPOSTAZIONE PARAMETRI** to configure the parameters, after entering the password

set by parameter "PAS".

The default value of parameter "PAS" is 743 and, irrespective of any new value that may be set, the number 743 will always give access to the "SETTING PARAMETERS" menu.

To set the password, use the slider at the bottom of the screen or the  and  keys. Press on the set value to save the password and access the list of parameters.

The screen will show the list of parameters and their value. Press the parameter to change and it will be displayed in orange. It can now be edited using the slider at the bottom of the screen or the  and  keys.

To confirm the change, press the set parameter again. If changes are made to parameters which alter the machine's operational features, the device will switch off and then automatically come back on again.

RESTORING PARAMETERS

Pressing "RESTORE PARAMETERS" **RIPRISTINA PARAMETRI** restores the EVCO default values.

To access, enter the password 149.

Graph screen



Pressing the "GRAPH"  key gives access to the screen where the temperature graph is displayed in real time.

Through parameter rE0, which can be set in 5-minute steps, it is possible to define the time scale of the graph as shown in the example below.



- If rE0 = 1
12 samplings at 1-minute intervals
(-12 min/+12 min)
- If rE0 = 5
12 samplings at 5-minute intervals
(-1 h/+1 h)
- If rE0 = 10
12 samplings at 10-minute intervals
(-2 h/+2 h)
- If rE0 = 60
12 samplings at 60-minute intervals
(-12 h/+12 h)

The controller charts the temperature of the last 12 samplings in real time.

The three lines on the graph indicate:



- The temperature of the product probe - blue
- The temperature of the cabinet probe - green
- The working setpoint - red

The dashed vertical line on the x axis indicates the samplings.

- The time and date of the first displayed measurement is at the bottom left
- The time of the last displayed measurement is at the bottom right

The window on the y axis goes from the lowest to the highest value recorded so all the data are included in it.

By pressing the navigation keys, it is possible to:

-  move the data processing window back 12 samplings
-  move the data processing window on 12 samplings

If there are no data, or if they are inconsistent, the device will not display them.

Configuring inputs/outputs

Configuring temperature probes

The controller can manage four PT1000 temperature probes, three of which are on the control module and one on the backup module.

The name of the first probe on the control module is set by parameter "Pr1"; similarly, the names of the other probes are set by parameters "Pr2", "Pr3" and "Pr4" based on the following settings:

- 0: "cabinet probe"
- 1: "evaporator probe"
- 2: "condenser probe"
- 3: "product probe"
- 4: "reference probe"
- 5: probe not present

The first probe on the control module will have the name defined by parameter "Pr1" on all the screens, while on the internal machine status screen, the four probes will be displayed as probe 1 - 2 - 3 - 4, irrespective of the name previously given.

It is possible to choose the probes to view from the "HOME" screen as:

- Main value: parameter "E19" value displayed in the centre
- Secondary value: parameter "E20" value displayed at the bottom left

The permitted values for these parameters are:

- 0 to view the first probe on the control module
- 1 to view the second probe on the control module
- 2 to view the third probe on the control module
- 3 to view the fourth probe on the backup module

Configuring digital outputs

The board enables users to configure each of the relay outputs on the control module and the I/O expansion.

The following configurations are possible:

- 0=compressor 1
- 1=compressor 2
- 2=evaporator fans
- 3=condenser 1 fans
- 4=defrosting
- 5=light
- 6=door frame heater
- 7=alarm
- 8=stand-by
- 9=condenser 2 fans
- 10=door lock

When several outputs are configured for the same function, the controller will only manage the first output configured.

The parameters from "u01c" to "u09c" configure the relays on the control module.

The parameters from "u10c" to "u13c" configure the relays on the I/O expansion (optional).

Configuring digital inputs

The controller can manage four digital inputs:

- 1 dedicated input which detects door status
- 3 multi-purpose (MP) inputs which can be configured to detect different things

The function associated with the MP inputs is set by parameters "i5 - i8 - i11" based on the following settings:

- 0 disabled
- 1 HP alarm compressor 1
- 2 HP alarm compressor 2
- 3 LP alarm compressor 1
- 4 LP alarm compressor 2
- 5 thermal switch alarm compressor 1
- 6 thermal switch alarm compressor 2
- 7 monitor voltage alarm
- 8 unused
- 9 energy saving

When several digital inputs are configured for the same function, the controller will only manage the first input configured.

Configuring the power meter input

Management of the power meter, which can be connected to the control module through RS-485 MODBUS, can be enabled from parameter E21.

To enable communication with the power meter, it must have the following MODBUS settings:

- Address = 2
- Baud rate = 9600
- Parity = even

The voltage and current thresholds are set through parameters E22, E23, E24 and E25.

Regulations

Compressor management

The compressor is activated when the temperature of the regulation probe is higher than the regulation setpoint value and is deactivated when the temperature of the regulation probe goes below the regulation setpoint value.

Depending on the type of differential set with parameter "r12" (symmetrical or asymmetrical), the value assigned to "r0" will be added to/subtracted from the setpoint value according to the following formulas:

- Asymmetrical hysteresis (r12 =0)
 - compressor activated with $t^{\circ} \geq SP+r0$
 - compressor deactivated with $t^{\circ} \leq SP$
- Symmetrical hysteresis (r12 =1)
 - compressor activated with $t^{\circ} \geq SP+r0$
 - compressor deactivated with $t^{\circ} \leq SP- r0$

The compressor is activated with a delay set by the safety times (parameters "C0 - C1 - C2 - C3") and, during defrost, by the dripping time ("d7").

The compressor is deactivated in the event of:

- Compressor maintenance alarm
- Open door and "i0" = 1 or 4
- Dirty condenser alarm
- Compressor HP alarm
- Compressor LP alarm
- Compressor thermal switch alarm
- Compressor protection alarm (parameter "i15"=1)

If the controller is configured to manage two compressor outputs, compressor 2 is activated/deactivated with a delay set by parameter "C11" in relation to the activation/deactivation of compressor 1.

Evaporator fan management

During normal operation, the evaporator fans operate according to the settings of parameter "F0":

- "F0 = 0" always off
- "F0 = 1" always on
- "F0 = 2" on if the compressor is switched on.
When the compressor is deactivated, the evaporator fans stay on for the time set by parameter "F9". Then they perform ON/OFF cycles set by parameters "F18" (ON time) and "F17" (OFF time)
- "F0 = 3" thermoregulated according to "F1", namely the value relative to the setpoint, based on the following formulas:
on if t° evaporator probe $< SP - F1$
off if t° evaporator probe $> SP - F1 + F8$
- "F0 = 4" thermoregulated if the compressor is on according to "F1", namely the value relative to the setpoint, based on the formulas indicated for "F0 = 3"
When the compressor is switched off, the evaporator fans stay on for the time set by parameter "F9".
- "F0 = 5" ON/OFF cycles set by parameters "F18" (ON time) and "F17" (OFF time).
- "F0 = 6" thermoregulated according to "F1", namely the value relative to the setpoint, based on the formulas:
on if t° evaporator probe $< F1$
off if t° evaporator probe $> F1 + F8$
- "F0 = 7" thermoregulated if the compressor is on according to "F1", namely the absolute value, based on the formulas indicated for "F0 = 3"
When the compressor is switched off, the evaporator fans stay on for the time set by parameter "F9".

Whenever fan management depends on the evaporator probe, the controller uses the replacement regulation probe if the probe is in alarm mode or not enabled.

The evaporator fans are switched off in the following conditions:

- Door open and the value set by parameter "i0" > 0 and ≠ 3
- Door open alarm
- 10 seconds after the door has been closed
- During fan downtime, after defrosting and/or when t° evaporator probe > "F7"
- Dirty condenser alarm

When activating the energy saving function, irrespective of the value set by parameter "F0", the fans are switched on according to the ON/OFF cycles set by parameters "F5" (ON time) and "F4" (OFF time).

During defrost, the behaviour of the fans is defined by the value set by parameter "F2":

"F2 = 0" evaporator fans always off

"F2 = 1" evaporator fans always on

Condenser fan management

The condenser fans are managed according to the settings of parameter "F10":

- "F10 = 0" thermoregulated according to "F11", with the following formulas:
on if t° condenser probe > "F11" + 5 °C
off if t° condenser probe < "F11"
If the condenser probe is in alarm mode, the fans come on in parallel with the compressor.
When the compressor is switched off, the fans stay on for the time set by parameter "F12".
- "F10 = 1" on if the compressor is switched on, thermoregulated according to "F11" if the compressor is switched off:
when the compressor is switched off, the fans stay on for the time set by parameter "F12" and are then managed according to the temperature of the condenser probe, based on the formulas indicated
for "F10=0"
If the condenser probe is in alarm mode, the fans come on in parallel with the compressor.
When the compressor is switched off, the fans stay on for the time set by parameter "F12".
- "F10 = 2" as "F10=1" during normal operation
always off during defrost

The condenser fans are always on when the dirty condenser alarm is on.

If there are two condenser fans to manage, the second one switches on/off in parallel with the first on.

Door frame heater management

The door frame heater is activated if: t° regulation probe < "u5".

It is deactivated if: t° regulation probe < "u5" + 2 °C.

The door frame heater is deactivated when the regulation probe is in alarm mode.

Alarm output management

The alarm output is activated:

- When there is an alarm (it is deactivated the moment the alarm stops)
- When the value set by parameter "u4" is equal to 1
- When the buzzer is deactivated (activated by an alarm signal)

The polarity of the alarm output is selected with parameter "A17":

- "A17 = 0" the output is activated when there is an alarm
- "A17 = 1" the output is activated when there is no alarm

ON/stand-by output management

The ON/stand-by output is activated if the board is ON and is deactivated if the board is OFF.

Light management

The light comes on when the door is opened if "i0" > 2, it goes off when the door is closed.
If "u2" = 1, the light can also be switched on/off manually by a key.

Door lock management

The door lock output is activated if the door lock is locked, it is deactivated if the door lock is unlocked.

Parameter "u6" defines the polarity of the output:

- "u6 = 0" the output is activated if the lock is not locked
- "u6 = 1" the output is activated if the lock is locked

Activation of the door lock depends on the polarity of the dedicated output which is set by parameter "u6":

- "u6 = 0" closed contact
- "u6 = 1" open contact

Defrost management

The defrost output is managed depending on the type of defrost selected with parameter "d1":

- "d1 = 0" electric defrost
During this kind of defrost:
 - the defrost output is activated
 - the compressor is deactivated
 - the evaporator and condenser fans are managed according to the value set by parameters "F2" and "F10"
- "d1 = 1" hot gas defrost
This type of defrost takes place when the compressor has been active for at least "d15" minutes. Otherwise the compressor must be activated and it is necessary to wait "d15" time.
When this time has elapsed
 - the defrost output is activated
 - the compressor remains activated
 - the evaporator/condenser fans are managed according to the value set by parameters "F2" and "F10".A dirty condenser alarm deactivates the compressor and defrost outputs
- "d1 = 2" defrost due to compressor off
This type of defrost takes place when the compressor is activated and the evaporator/condenser fans are managed according to the value set by parameters "F2" and "F10".

Whatever the reason for defrosting, it is only activated if the temperature detected by the evaporator probe is lower than the value set by parameter "d2", or if there is no probe or it is in alarm mode.

If the evaporator probe is present, defrost will be complete when the temperature recorded by the probe reaches the value set by parameter "d2".

If the temperature is not reached within the maximum duration of the defrost, set by the value of parameter "d3", defrost will be complete and will be signalled by an alarm if the value set by parameter "d11" is 1.

At the end of any defrost, users must wait the time of the sum of the values of "d16" and "d7" for the compressor to be reactivated and the time of the sum of the values of "d16", "d7" and "F3" for the evaporator fans to be reactivated.
Once the time of the sum of the values of "d16" and "d7" has elapsed and the temperature of the evaporator probe is lower than the value set by parameter "F7", the fans may be reactivated.

Operating mode: “defrost”

Defrost can be activated manually from the user interface (through the dedicated icon in the “main menu”) or automatically in the following cases:

- “d4 = 1” At switch-on after a delay of “d5” minutes
- “d8 = 0” Every “d0” hours of machine operation
- “d8 = 1” Every “d0” hours of compressor operation
- “d8 = 2” If the evaporator probe temperature remains below the value set by parameter “d9” for time “d0”
- “d8 = 3” By a smart defrost algorithm (adaptive defrost)

Adaptive defrost is activated according to an assessment of the temperature trend of the evaporator probe. The algorithm is based on a calibration process in which the temperature reached by the evaporator is measured. At the end of the calibration process, a threshold value for the evaporator probe is obtained and this is used to determine when to defrost or not.

The calibration process can be repeated after:

- Defrosting
- Board is switched on
- Energy saving

Adaptive defrost starts up when the following conditions are met:

- t° evaporator probe < t° calibration – “d19”
- t° evaporator probe < t° calibration – “d22” for time > “d18”.

Operating mode: “energy saving”

In energy saving mode, when conditions allow, the controller regulates at a higher setpoint because it is corrected by an offset which is set with parameter “r4”.

The energy saving function is activated in the following cases:

- Automatic energy saving activated by time
This is activated every day at the time set by parameter “H01”.
If the value set by parameter “H01” is the same as 24, the energy saving mode is disabled.
The duration of the energy saving function in this case is set by parameter “H02”.
- Manual energy saving from input
This is activated by closing a digital input.
To enable this function, it is necessary to configure a digital input from the multi-purpose (MP) inputs as an energy saving input.
In this case, the energy saving function is deactivated when the digital input is opened or when the time set by parameter “HE2” has elapsed.
- Automatic energy saving activated by door closed time
This is activated when the door remains closed for the time set by parameter “i14”.
If the value set by parameter “i14” is 0, the energy saving function is disabled.
Opening the door deactivates the function.

USB port management

The following operations can be carried out through the USB port:

- Download the parameters saved in the controller to a USB flash drive
- Upload the parameters in the USB flash drive to the controller
- Download the historical data to a USB flash drive

These functions are available when the board is ON.

When a USB flash drive is connected to the relative communications port, a pop-up window will appear where one of the possible operations can be selected.

Once the operation has been carried out, wait until OK has appeared on the display before removing the USB flash drive.

When downloading the historical data, it is possible to select the start date to download the stored data.

Press the "OK"  key to begin the data download and follow the instructions on the display to continue.

To prevent the "storico.csv" file to be damaged, when downloading the file a CRC (cyclic redundancy check) is performed for each file line.

EPoCA cloud platform

EPoCA is a remote management and monitoring system based on a cloud platform. All that is needed is a simple onsite Wi-Fi Internet connection to enable the controller, using the EVlink Wi-Fi module, to connect to the cloud system, making it possible to remotely manage equipment from a PC, tablet or smartphone.

The responsive design and the graphic interface conceived to provide a pleasant user experience make EPoCA a "ready-to-use" solution for easily accessible monitoring operations, even for entry-level users, while offering all the typical functions of professional platforms.

With the appropriate protection measures for access and data, the system makes it possible for one or more enabled users to operate remotely on the unit to configure its parameters, view HACCP data (also as a graph) and download records in the most popular formats, such as XLSX, CSV and PDF. One of the functions that plays a key role are the alerts which are sent automatically by the system to selected e-mail addresses.

Schematic diagram:

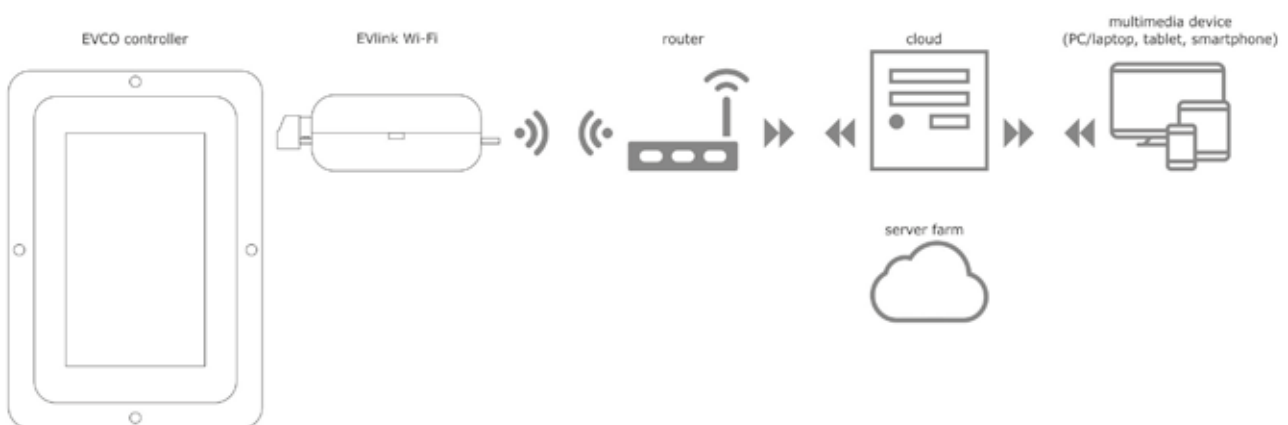

For more details about the EVlink Wi-Fi module and the EPoCA cloud platform, consult the "EPoCA" manual on our website www.evco.it.

Alarms

When there is an alarm, a buzzer will sound and the  icon will appear.

The kind of alarm is indicated by a message at the top of the screen, for example **ALL. SONDA CELLA**.

To silence the buzzer, press the icon "BUZZER" .

Some alarms are automatically reset when the cause of the alarm disappears, while others (e.g. power failure, defrost timeout) are manually re-armed by accessing the "ALARM SETUP" screen.

Table of alarms

Alarm label	Description
CABINET PROBE AL.	Cabinet probe alarm To correct: <ul style="list-style-type: none"> - Check the device-cabinet probe connection - Check the cabinet temperature Main results: <ul style="list-style-type: none"> - If the cabinet probe is the regulation probe, regulation will pass to the product probe if present, otherwise the compressor will follow ON/OFF cycles set by parameters "C4" and "C5"
EVAPORATOR PROBE AL.	Evaporator probe alarm To correct: <ul style="list-style-type: none"> - Check the device-evaporator probe connection - Check the cabinet temperature
CONDENSER PROBE AL.	Condenser probe alarm To correct: <ul style="list-style-type: none"> - Check the device-condenser probe connection - Check the cabinet temperature Main results: <ul style="list-style-type: none"> - The condenser fans will operate in parallel with the compressor - The condenser overheat alarm will never be activated - The compressor locked alarm will never be activated
PRODUCT PROBE AL.	Product probe alarm To correct: <ul style="list-style-type: none"> - Check the device-product probe connection - Check the cabinet temperature Main results: <ul style="list-style-type: none"> - If the product probe is the regulation probe, regulation will pass to the cabinet probe if present, otherwise the compressor will follow ON/OFF cycles set by parameters "C4" and "C5"
REFERENCE PROBE AL.	Reference probe alarm To correct: <ul style="list-style-type: none"> - Check the device-reference probe connection - Check the cabinet temperature
DOOR OPEN	Door open alarm To correct: <ul style="list-style-type: none"> - Check the condition of the door - Check the value of parameters "i0 - i1 - i2"
TIMEOUT DEFROST	Defrost terminated alarm due to timeout (parameter "d3") Signal only. The alarm is reset by consulting the "ALARM SETUP" screen
HIGH TEMP. CABINET	High cabinet temperature alarm To correct: <ul style="list-style-type: none"> - Check the cabinet temperature - Check the value of parameter "A9" or "A11" depending on the configuration as absolute or relative values set with parameter "A5"
PRE-ALARM HIGH T. CABINET	High cabinet temperature pre-alarm To correct: <ul style="list-style-type: none"> - Check the cabinet temperature - Check the value of parameter "A13" or "A15" depending on the configuration as absolute or relative values set with parameter "A5"

Alarm label	Description
PRE-ALARM LOW T. CABINET	High cabinet temperature pre-alarm To correct: <ul style="list-style-type: none"> - Check the cabinet temperature - Check the value of parameter "A12" or "A11" depending on the configuration as absolute or relative values set with parameter "A5"
LOW TEMP. CABINET	Low cabinet temperature alarm To correct: <ul style="list-style-type: none"> - Check the cabinet temperature - Check the value of parameter "A8" or "A10" depending on the configuration as absolute or relative values set with parameter "A5"
HIGH TEMP. PRODUCT	High product temperature alarm To correct: <ul style="list-style-type: none"> - Check the temperature of the product probe - Check the value of parameter "A9b" or "A11b" depending on the configuration as absolute or relative values set with parameter "A5b"
PRE-ALARM HIGH T. PRODUCT	High product temperature pre-alarm To correct: <ul style="list-style-type: none"> - Check the temperature of the product probe - Check the value of parameter "A13b" or "A15b" depending on the configuration as absolute or relative values set with parameter "A5b"
PRE-ALARM LOW T. PRODUCT	Low product temperature pre-alarm To correct: <ul style="list-style-type: none"> - Check the temperature of the product probe - Check the value of parameter "A12b" or "A14b" depending on the configuration as absolute or relative values set with parameter "A5b"
LOW TEMP. PRODUCT	Low product temperature alarm To correct: <ul style="list-style-type: none"> - Check the temperature of the product probe - Check the value of parameter "A8b" or "A10b" depending on the configuration as absolute or relative values set with parameter "A5b"
COMPR.MAINTENANCE	Compressor maintenance alarm To correct: <ul style="list-style-type: none"> - Check the operating time of the compressor - Check the value of parameter "C10" Main results: <ul style="list-style-type: none"> - There is no effect if the alarm is visualised, it will be reset and will be displayed again after the compressor has worked for a week
HIGH CONDENSATION PRE AL	Dirty condenser alarm To correct: <ul style="list-style-type: none"> - Check the condenser temperature - Check the value of parameter "C6" Main results: <ul style="list-style-type: none"> - The condenser fans will be switched on and the compressor and evaporator fans will be switched off
HIGH CONDENSATION	Compressor locked alarm To correct: <ul style="list-style-type: none"> - Check the condenser temperature - Check the value of parameters "C7" and "C8" - Disconnect the device from the power supply and clean the condenser
POWER FAILURE	Power supply restored alarm after a power failure > A4 To correct: <ul style="list-style-type: none"> - Check the device-power supply connection - Check the value of parameter "A4"

Alarm label	Description
COMPRESSOR 1 HP	HP pressure switch alarm compressor 1 To correct: – Check the condition of the multi-purpose input (MP) associated with this function Main results: – Compressor 1 off
COMPRESSOR 2 HP	HP pressure switch alarm compressor 2 To correct: – Check the condition of the multi-purpose input (MP) associated with this function Main results: – Compressor 2 off
COMPRESSOR 1 LP	LP pressure switch alarm compressor 1 To correct: – Check the condition of the multi-purpose input (MP) associated with this function Main results: – Compressor 1 off
COMPRESSOR 2 LP	LP pressure switch alarm compressor 2 To correct: – Check the condition of the multi-purpose input (MP) associated with this function Main results: – Compressor 2 off
THERMAL COMPRESSOR 1	Thermal switch alarm compressor 1 To correct: – Check the condition of the multi-purpose input (MP) associated with this function Main results: – Compressor 1 off
THERMAL COMPRESSOR 2	Thermal switch alarm compressor 2 To correct: – Check the condition of the multi-purpose input (MP) associated with this function Main results: – Compressor 2 off
VOLTAGE CONTROL	Compressor protection alarm To correct: – Check the condition of the multi-purpose input (MP) associated with this function Main results: – None, if "i15" = 0 – Compressors off, if "i15" = 1
COMMUNICATION	No communication with board alarm To correct: – Check connections
EXP COMMUNICATION	No communication with I/O expansion alarm To correct: – Check connections – Check the value of parameter "E18"
BATTERY COMM	Communication alarm with backup module To correct: – Check connections – Check the value of parameter "E18"
BATTERY ALARM	Battery faulty alarm To correct: – Check connections between the battery and the backup module – Check integrity of the battery
EMERGENCY POWER SUPPLY	Emergency power supply underway alarm To correct: – Check power supply Main results: – Regulation will pass to the probe in the backup module

Alarm label	Description
CO2 BACKUP	Alarm occurring when backup probe temperature > u9+u10 (if u14c = 2) Main results: - The backup module relay will be activated
THERMOSTAT AL	Alarm occurring when backup probe temperature > u9+u10 (if u14c = 3) Main results: - The backup module relay will be activated
ANTIFREEZE	Alarm occurring when backup probe temperature > u9+u10 (if u14c = 4) Main results: - The backup module relay will be activated
POWER METER LINK AL	No communication with power meter alarm (if E21 = 1) To correct: - Check connections Main results: - Current and voltage values detected by power meter are not available
LOW VOLTAGE AL	Alarm occurring when voltage < E23 (if E21 = 1) To correct: - Check absorption and wiring Main results: - Alarm message display only
HIGH VOLTAGE AL	Alarm occurring when voltage > E22 (if E21 = 1) To correct: - Check absorption and wiring Main results: - Alarm message display only
LOW CURRENT AL	Alarm occurring when current < E25 (if E21 = 1) To correct: - Check absorption and wiring Main results: - Alarm message display only
HIGH CURRENT AL	Alarm occurring when current > E24 (if E21 = 1) To correct: - Check absorption and wiring Main results: - Alarm message display only

List of parameters

Label	Description	Min	Max	Default	UM
SP	Setpoint	-99.9	99.9	-40.0	°C/F
CA1	Probe 1 offset	-25.0	25.0	0	°C/F
CA2	Probe 2 offset	-25.0	25.0	0	°C/F
CA3	Probe 3 offset	-25.0	25.0	0	°C/F
CA4	Probe 4 offset	-25.0	25.0	0	°C/F
P1	Enable decimal point °C 0 no 1 yes	0	1	1	
P2	Temperature measurement unit 0 Celsius 1 Fahrenheit	0	1	0	
P3	UNUSED				
P6	Choice of regulation probe 0 cabinet 1 product	0	1	0	
Pr1	Name probe 1 0 cabinet 1 evaporator 2 condenser 3 product 4 reference 5 not present	0	5	0	
Pr2	Name probe 2 See Pr1	0	5	1	
Pr3	Name probe 3 See Pr1	0	5	2	
Pr4	Name probe 4 See Pr1	0	5	3	
r0	Setpoint differential	0.1	15	2.0	°C/F
r1	Minimum setpoint	-99.9	99.9	-40.0	°C/F
r2	Maximum setpoint	-99.9	99.9	50.0	°C/F
r3	Setpoint lock 0 no 1 yes	0	1	0	
r4	Setpoint offset in energy saving	0	99.0	0	°C/F
r12	Differential position r0 0 asymmetrical 1 symmetrical	0	1	0	
r13	UNUSED				
r14	UNUSED				
r15	UNUSED				
CP0	UNUSED				
C0	Compressor ON delay from power-on	0	240	0	min
C1	Delay between 2 compressor switch-ons	0	240	5	min
C2	Minimum compressor-off duration	0	240	3	min
C3	Minimum compressor-on duration	0	240	0	s
C4	Compressor OFF time in cabinet probe alarm	0	240	10	min
C5	Compressor ON time in cabinet probe alarm	0	240	10	min

Label	Description	Min	Max	Default	UM
C6	High condensation signal threshold	0.0	164.0	80.0	°C/F
C7	High condensation alarm threshold (once "C8" has elapsed)	0.0	164.0	90.0	°C/F
C8	Delay of compressor locked alarm (due to threshold "C7" exceeded)	0	15	1	min
C9	UNUSED				
C10	Operating time of compressor due to maintenance warning 0=disabled	0	999	0	d
C11	Compressor 2 ON delay from compressor 1 ON	0	999	3	s
d0	Automatic defrost interval	0	99	8	h
d1	Type of defrost 0 electric 1 hot gas 2 compressor off	0	2	0	
d2	Evaporator threshold end of defrost	-99.0	99.0	2.0	°C/F
d3	Maximum duration of defrost	0	99	30	min
d4	Enable defrost at power ON 0 no 1 yes	0	1	0	
d5	Defrost delay from power ON	0	99	0	min
d6	Value displayed when defrosting 0 regulation value 1 locked display	0	1	1	
d7	Dripping time	0	15	2	min
d8	Count mode of automatic defrost interval "d0" 0 hours device ON 1 hours compressor ON 2 evaporator temperature < "d9" 3 adaptive	0	3	0	
d9	Evaporation threshold for automatic defrost interval count (if "d8 = 2")	-99.9	99.0	0	°C/F
d11	Enable defrost timeout alarm 0 no 1 yes	0	1	0	
d15	Consecutive compressor ON time for starting hot gas defrost when defrost interval elapses	0	99	0	min
d16	Pre-dripping time for hot gas defrost	0	99	0	min
d18	Adaptive defrost interval	0	999	40	min
d19	Threshold in relation to optimal evaporation temperature for starting adaptive defrost	0	40.0	3.0	°C/F
d22	Threshold in relation to optimal evaporation temperature due to suspension of adaptive defrost interval count	-10.0	10.0	-2.0	°C/F
A1	High temperature alarm delay from power ON	0	240	120	min
A2	High temperature alarm delay from defrost	0	240	15	min
A3	High temperature alarm delay from door closure	0	240	15	min
A4	Duration of power failure due to recording PF alarm -1 alarm disabled	-1	240	10	min
A5	Type of high/low cabinet temperature alarm 0 relative 1 absolute	0	1	0	
A6	High/low cabinet temperature alarm delay	0	900	0	s
A7	High/low cabinet temperature alarm reset differential	0	20.0	2.0	°C/F

Label	Description	Min	Max	Default	UM
A8	Absolute threshold for low cabinet temp. alarm	-99.0	99.9	-50.0	°C/F
A9	Absolute threshold for high cabinet temp. alarm	-99.0	99.9	25.0	°C/F
A10	Threshold relative to setpoint for low cabinet temperature alarm	-50.0	0	-3.0	°C/F
A11	Threshold relative to setpoint for high cabinet temperature alarm	0	50.0	4.0	°C/F
A12	Absolute threshold for low cabinet temperature pre-alarm	-99.0	99.9	-50.0	°C/F
A13	Absolute threshold for high cabinet temperature pre-alarm	-99.0	99.9	25.0	°C/F
A14	Threshold relative to setpoint for low cabinet temperature pre-alarm	-50.0	0	-3.0	°C/F
A15	Threshold relative to setpoint for high cabinet temperature pre-alarm	0	50.0	4.0	°C/F
A5b	Type of high/low product temperature alarm 0 relative 1 absolute	0	1	0	
A6b	High/low product temperature alarm delay	0	900	0	s
A7b	High/low product temperature alarm reset differential	0	20.0	2.0	°C/F
A8b	Absolute threshold for low product temperature alarm	-99.0	99.9	-50.0	°C/F
A9b	Absolute threshold for high product temperature alarm	-99.0	99.9	25.0	°C/F
A10b	Threshold relative to setpoint for low product temperature alarm	-50.0	0	-3.0	°C/F
A11b	Threshold relative to setpoint for high product temperature alarm	0	50.0	4.0	°C/F
A12b	Absolute threshold for low product temperature pre-alarm	-99.0	99.9	-50.0	°C/F
A13b	Absolute threshold for high product temperature pre-alarm	-99.0	99.9	25.0	°C/F
A14b	Threshold relative to setpoint for low product temperature pre-alarm	-50.0	0	-3.0	°C/F
A15b	Threshold relative to setpoint for high product temperature pre-alarm	0	50.0	4.0	°C/F
A16	Alarm buzzer reactivation time	0	900	0	s
A17	Alarm output activation 0 with alarm active 1 with alarm not active	0	1	0	
F0	Evaporator fan mode in normal operation 0 OFF 1 ON 2 ON if compressor on 3 thermoregulated according to "F1" (as value relative to SP) 4 thermoregulated if compressor is ON according to "F1" (as value relative to SP) 5 ON/OFF cycles ("F17" and "F18") 6 thermoregulated according to "F1" (as absolute value) 7 thermoregulated if compressor is ON according to "F1" (as absolute value)	0	7	1	
F1	Evaporation threshold for evaporator fan regulation	-99.9	99.0	-4.0	°C/F
F2	Evaporator fan mode during defrost 0 OFF 1 ON	0	1	0	
F3	Maximum time evaporator fans OFF after dripping	0	15	2	min
F4	Time evaporator fans OFF in energy saving	0	240	30	s x 10
F5	Time evaporator fans ON in energy saving	0	240	30	s x 10
F7	Absolute threshold to start fans up again after defrost	-99.0	99.0	5.0	°C/F

Label	Description	Min	Max	Default	UM
F8	Evaporator setpoint differential	1.0	15.0	2.0	°C/F
F9	Evaporator fans OFF delay from compressor OFF	0	240	10	s
F10	Condenser fan mode 0 thermoregulated 1 thermoregulated if compressor OFF 2 thermoregulated if compressor OFF, OFF in defrost	0	2	1	
F11	Condenser fans ON threshold	0	99.0	15.0	°C/F
F12	Condenser fans OFF delay from compressor OFF	0	240	30 sec	s
F17	Evaporator fans time OFF	0	240	60	s x 10
F18	Evaporator fans time ON	0	240	10	s x 10
i0	Door switch input function 0 disabled 1 compressor + evaporator fans OFF 2 evaporator fans OFF 3 light ON 4 compressor + evaporator fans OFF + light ON 5 evaporator fans OFF + light ON	0	5	5	
i1	Door switch input activation 0 contact closed 1 contact open	0	1	0	
i2	Door open alarm delay -1 unused	-1	120	30	min
i3	Time for inhibiting compressor and fan regulation from door open	-1	120	15	min
i5	Multi-purpose input 1 function 0 disabled 1 HP alarm compressor 1 2 HP alarm compressor 2 3 LP alarm compressor 1 4 LP alarm compressor 2 5 thermal switch alarm compressor 1 6 thermal switch alarm compressor 2 7 compressor protection alarm 8 unused 9 energy saving	0	9	1	
i6	Multi-purpose input 1 activation 0 contact closed 1 contact open	0	1	0	
i7	Multi-purpose input 1 alarm delay	0	999	0	s
i8	Multi-purpose input 2 function See i5	0	9	1	
i9	Multi-purpose input 2 activation 0 contact closed 1 contact open	0	1	0	
i10	Multi-purpose input 2 alarm delay	0	999	0	s
i11	Multi-purpose input 3 function See i5	0	9	1	
i12	Multi-purpose input 3 activation 0 contact closed 1 contact open	0	1	0	
i13	Multi-purpose input 3 alarm delay	0	999	0	s
i14	Door closed consecutive time for energy saving 0 disabled	0	999	0	min

Label	Description	Min	Max	Default	UM
i15	Compressor protection effect 0 none 1 compressors OFF	0	1	0	
u01c	Output K1 configuration 0 compressor 1 1 compressor 2 2 evaporator fans 3 condenser 1 fans 4 defrost 5 light 6 heater 7 alarm 8 on/stand-by 9 condenser 2 fans 10 door lock	0	10	1	
u02c	Output K2 configuration See u01c	0	10	2	
u03c	Output K3 configuration See u01c	0	10	3	
u04c	Output K4 configuration See u01c	0	10	4	
u05c	Output K5 configuration See u01c	0	10	5	
u06c	Output K6 configuration See u01c	0	10	6	
u07c	Output K7 configuration See u01c	0	10	7	
u08c	Output K8 configuration See u01c	0	10	8	
u09c	Output K9 configuration See u01c	0	10	9	
u10c	Output K10 configuration (first relay on I/O expansion) See u01c	0	10	10	
u11c	Output K11 configuration (second relay on I/O expansion) See u01c	0	10	0	
u12c	Output K12 configuration (third relay on I/O expansion) See u01c	0	10	0	
u13c	Output K13 configuration (fourth relay on I/O expansion) See u01c	0	10	0	
u14c	Output K14 configuration (relay on backup module) 0 disabled 1 power failure alarm 2 "CO2" backup alarm 3 safety thermostat alarm (delay u8 not in use) 4 antifreeze alarm	0	4	0	
u2	Enable light by key 0 no 1 yes	0	1	1	
u4	Deactivate alarm output by silencing buzzer 0 no 1 yes	0	1	1	

Label	Description	Min	Max	Default	UM
u5	Door heaters threshold	-99.0	99.0	-1.0	°C/F
u6	Door lock activation 0 contact closed 1 contact open	0	1	0	
u7	Enable alarm buzzer 0 no 1 yes	0	1	1	
u8	Backup module alarm delay	0	1440	300	min
u9	Backup module alarm threshold	-99.0	99.0	10.0	°C/F
u10	"CO2" backup alarm reset differential	1.0	15.0	2.0	
HE2	Maximum duration energy saving from key or door inactivity	0	999	0	min
H01	Automatic energy saving activation time	0	24	24	h
H02	Automatic energy saving duration	0	24	0	h
POF	UNUSED				
LOC	UNUSED				
PAS	Password to access settings	-99	999	743	
PA1	First level password (EVconnect/EPoCA)	-99	999	426	
PA2	Second level password (EVconnect/EPoCA)	-99	999	824	
bLE	Serial port configuration for connectivity 0 free 1 forced for EVconnect or EPoCA 2-99 EPoCA local network address	0	99	1	
rE0	Data logger sampling interval	1	60	15	min
rE1	UNUSED				
LA	MODBUS address	1	247	247	
Lb	MODBUS baud rate 0 2,400 baud 1 4,800 baud 2 9,600 baud 3 19,200 baud	0	3	2	
LP	MODBUS parity 0 none 1 odd 2 even	0	2	2	
E9	Enable EVCO splash screen 0 no 1 yes	0	1	0	
E17	Enable users 0 no 1 yes	0	1	0	
E18	Enable accessories modules 0 none 1 only I/O expansion module 2 only backup module 3 all	0	3	0	
E19	Main value on display 0 probe 1 1 probe 2 2 probe 3 3 probe 4	0	3	0	

Label	Description	Min	Max	Default	UM
E20	Secondary value on display 0 probe 1 1 probe 2 2 probe 3 3 probe 4	0	3	3	
E21	Enable power meter 0 no 1 yes	0	1	0	
E22	Maximum voltage threshold	-1	999	0	V
E23	Minimum voltage threshold	-1	999	230	V
E24	Maximum current threshold	-1	999	0	A
E25	Minimum current threshold	-1	999	50	A

N.B.

- after a parameter has been changed, the board switches off and then automatically comes back on.

- after the rE0 value has been changed, we recommend downloading the data in the history and then deleting the history; alternatively, wait for a time period equal to 12 samplings before viewing the temperature graph.

Accessories

Connecting cables

0810500018/0810500020

Allows connection via a USB to a PC or an accessory with a USB port.

Cable length

Code	Length
0810500018	2 m
0810500020	0.5 m



USB flash drive

EVUSB4096M

Allows configuration upload and download.
4GB of memory.



RS-485/USB serial interface

EVIF20SUXI

Using the RS-485 communications port, the controller can be connected to the Parameters Manager set-up software.



Safety transformer

ECTSFD004

The transformer can power the Vcolor 279 L user interface.



USB plug for panel installation

0812000002

This plug grants access to the controller's USB communications port.

To connect the port to the plug, connecting cable 0810500018 or 0810500020 must be used (to be ordered separately).



4 relay I/O expansion

EVC20P52N9XXX10

It is possible to increase the number of outputs to the controller through the I/O expansion with 4 additional relays.

The relays on this board can be configured using parameters "u10c - u11c - u12c - u13c".



Backup module

EVPS9B

The backup module ensures the temperature measured by a product probe is recorded for the duration of the autonomy of a backup battery, should the controller experience a loss of power



EVlink Wi-Fi RS-485 module

EVIF25SWX

Through the RS-485 communications port, it provides the controller with Wi-Fi connectivity which enables remote management and monitoring from the Internet using the EPoCA cloud system.



Technical specifications

User interface - Control module

Type	Description	
Purpose of the control device	Function controller	
Construction of the control device	Built-in electronic device	
Housing	User interface	Open frame board behind glass
	Control module	Open frame board
Category of heat and fire resistance	D	
Measurements	Vcolor 279 M user interface	Flush-fit installation: 166,0 x 118,0 x 35,0 mm (6,535 x 4,645 x 1,377 in; L x H x D) Frontal installation: 145,1 x 97,1 x 32,0 mm (5.712 x 3.822 x 1.259 in; L x H x D)
	Vcolor 279 L user interface	Flush-fit installation: 216,0 x 156,0 x 50,0 mm (8,503 x 6,141 x 1,968 in; L x H x D) Frontal installation: 192,9 x 131,9 x 47,0 mm (7.594 x 5.192 x 1.850 in; L x H x D)
	Control module	– 166 x 116 x 44 mm
Mounting methods for the control device	User interface	Flush with the panel from behind with threaded studs (not provided) to hold it in place or semi-recessed from the front of the panel using the spring clips
	Control module	On a flat surface with spacers
Degree of protection provided by the casing	User interface	IP65 (front)
	Control module	IP00
Connection method	User interface	– Plug-in screw terminal blocks for wires up to 1.5 mm ² – Type "A" female USB connector (USB port)
	Control module	– Plug-in screw terminal blocks for wires up to 2.5 mm ²
Maximum permitted length for connection cables	Power supply: 10 m	
	User interface-control module connection: 10 m	
	Analogue inputs: 10 m	
	Digital inputs: 10 m	
	Analogue outputs: 10 m	
	Digital outputs: 100 m	
	RS-485 MODBUS port: 1,000 m USB port: 1 m	
Operating temperature	0 – 55 °C	
Storage temperature	-10 – 70 °C	
Operating humidity	Relative humidity without condensate from 10 to 90%	
Pollution status of the control device	2	
Compliance	– RoHS 2011/65/EC	
	– WEEE 2012/19/EU	
	– REACH (EC) Regulation no. 1907/2006	
	– EN 60730-1	
	– IEC 60730-1	

Type	Description	
Power supply	Vcolor 279 M user interface	Powered by the control module or backup module
	Vcolor 279 L user interface	Powered by the backup module
	Control module	115... 230 VAC (±15%), 50/60 Hz (±3 Hz), 10 VA max.
Rated impulse-withstand voltage	4 KV	
Over-voltage category	III	
Software class and structure	A	
Clock	Built-in	With secondary lithium battery
	Clock drift	≤ 60 s/month at 25 °C
	Clock battery autonomy in the absence of a power supply	> 6 months at 25 °C
	Clock battery charging time	24 h The battery is charged by the power supply of the device
Analogue inputs	3 inputs PT1000 2 configurable wires	Cabinet, evaporator and condenser probes
	1 input 4-20 mA	Humidity probe
PT1000 type analogue inputs	Measurement field	-100 – 100 °C
	Resolution	1 °C
	Protection	None
4-20 mA type analogue inputs	Measurement field	Configurable
	Protection	None
Digital inputs	4 dry contact inputs	Door switch, compressor thermal switch, low pressure switch and high pressure switch
Digital inputs dry contact	Contact type	5 VDC, 2 mA
	Power supply	None
Digital outputs	9 outputs	Electro-mechanical relays, res. at 250 VAC
	1 x 16 A type SPST (K1) output	Compressor management
	1 x 8 A type SPST (K2) output	Cabinet light management (the relays do not manage LED or fluorescent lamps)
	1 x 8 A type SPST (K3) output	Condenser fan management
	1 x 8 A type SPST (K4) output	Evaporator fan management
	1 x 8 A type SPDT (K5) output	Alarm management
	1 x 16 A type SPST (K6) output	Door lock management
	1 x 16 A type SPST (K7) output	Battery testing
	1 x 10 A type SPST (K8) output	Door heater management
	1 x 10 A type SPST (K9) output	Defrost management
Displays	5 or 7-inch TFT touch-screen graphic display, 16K colours, 800 x 480 pixel resolution. The presence of imperfection points on the display is within the tolerance limits as established by the reference standards	
Type 1 or Type 2 actions	Type 1	
Additional features of Type 1 or Type 2 actions	C	
Communications ports	– 1 USB port	
	– 1 RS-485 MODBUS port	
Warning and alarm buzzer	Built-in	



EVCO S.p.A.

Via Feltre 81, 32036 Sedico (BL) ITALY

| Tel. +39 0437 8422

| Fax +39 0437 83648

| e-mail info@evco.it

| web www.evco.it

This document and the solutions contained therein are the intellectual property of EVCO and thus protected by the Italian Intellectual Property Rights Code (CPI). EVCO imposes an absolute ban on the full or partial reproduction and disclosure of the content other than with the express approval of EVCO. The customer (manufacturer, installer or end user) assumes all responsibility for the configuration of the device.

EVCO accepts no liability for any possible errors in this document and reserves the right to make any changes at any time without prejudice to the essential functional and safety features of the equipment.