



Vcolor 368

**Controllers for combination ovens
for gastronomy and pastry making**



ENGLISH

INSTALLER MANUAL ver. 3.0

CODE 144VC368E304



Important

Read this document carefully before installation and before using the device and take all the prescribed precautions. Keep this document with the device for future consultation.

Only use the device in the ways described in this document. Do not use the device as safety device.



Disposal

The device must be disposed of according to local regulations governing the collection of electrical and electronic equipment.

Index

1	INTRODUCTION.....	4	11	BURNER EXPANSION	35
1.1	Product description	4	11.1	Activating expansion	35
1.2	Models available and hardware features	5	11.2	Managing a modulated air blown burner	35
2	INSTALLATION	8	11.2.1	Hall sensor (b16)	35
2.1	Format features.....	8	11.2.2	Flame presence (b17).....	35
2.2	Measurements and installation	8	11.2.3	Burner fault (b15).....	35
2.3	Vcolor 368M electrical connection	11	11.2.4	Error management	35
2.4	Vcolor 368L electrical connection	13	11.3	On-off atmospheric burner management.....	36
3	OPERATING THE DEVICE	19	11.3.1	Flame presence (b17).....	36
3.1	Switching the device on/off	19	11.3.2	Burner fault (b15).....	36
3.2	Power failure.....	19	11.3.3	Error management	36
3.3	Silencing the buzzer.....	19	11.4	Electrical connection.....	36
4	NAVIGATION.....	19	11.5	Application diagram.....	37
4.1	Initial information	19	12	MANAGING THE LOADS	38
4.2	Manual cooking	20	12.1	Temperature regulation	38
4.3	Cooking from the recipe book.....	20	12.2	Steam injection	38
4.4	Special cycles.....	20	12.3	Venting.....	38
4.5	Settings and status	21	12.4	Chamber light.....	38
4.5.1	Clock.....	21	12.5	Electronics compartment fan	38
4.5.2	Internal status	22	12.6	Fan	38
4.5.3	Service.....	22	12.7	Fume reduction.....	38
4.5.4	Languages	22	12.8	Managing outputs for special washing cycles	39
5	Planning	23	12.8.1	Washing with liquid detergent, without recirculation of the water (W17 = 1)	39
6	COOKING FUNCTION.....	24	12.8.2	Washing with tablet detergent, with recirculation of the water (W17 = 2).....	40
6.1	Initial information	24	13	EPOCA CLOUD PLATFORM	43
6.2	Method of operation for ventilated bread and pastry- making ovens.....	25	14	LIST OF CONFIGURATION PARAMETERS	44
6.3	Setting the cooking cycle	25	15	USING THE USB PORT	53
6.4	Starting/interrupting the cooking cycle	26	15.1	Initial information	53
7	"RECIPE BOOK" FUNCTION	28	15.2	Uploading the program settings	53
7.1	Initial information	28	15.3	Downloading the program settings	53
7.2	Storing "My recipes".....	28	15.4	Uploading the settings in the configuration parameters 53	
7.3	Starting up a recipe	29	15.5	Downloading the settings in the configuration parameters 53	
7.4	Deleting a recipe	29	15.6	Download of HACCP data stored within the controller54	
8	SPECIAL CYCLES FUNCTION.....	30	16	ALARMS.....	55
8.1	Initial information	30	16.1	Alarms.....	55
8.2	"À LA CARTE" cooking cycle	31	17	ACCESSORIES	59
9	"WEEKLY PROGRAMMED SWITCH-ON" FUNCTION ...	32	17.1	EVlink Wi-Fi RS-485 module	59
9.1	Initial information	32	17.2	Non-optoisolated RS-485/USB serial interface	59
9.2	Setting the "Weekly programmed switch-on" function32		17.3	USB plug for panel installation	59
9.3	Activating the "Weekly programmed switch-on" function 32		17.4	Connecting cables 0810500018/0810500020	59
10	BOILER EXPANSION	33	17.5	4GB USB flash drive EVUSB4096M	60
10.1	Activating expansion	33	18	TECHNICAL SPECIFICATIONS	61
10.2	Electrical connection	33	18.1	Technical specifications.....	61
10.3	Operation	33			
10.3.1	Water load management.....	33			
10.3.2	Water heating management	33			
10.3.3	Boiler rinsing.....	33			
10.3.4	Boiler washing.....	34			

1 INTRODUCTION

1.1 Product description

Vcolor 368 M & L controllers manage all the most up-to-date functions of electric combination ovens for gastronomy and pastry-making. Additional optional modules also make it possible to control ovens with an external boiler and gas burners.

Their innovative programmable platform enables the OEM, completely independently and without the use of additional software or hardware, to personalise the user interface graphics to an advanced degree, to set up the recipe book with high quality photographs and to add new machine interface languages.

Upon request, the controllers can be equipped with Wi-Fi connectivity so it can interact remotely with the unit through the EPoCA® cloud platform, with the option of starting/stopping working cycles.

Available in a 5 or 7-inch version with a capacitive colour TFT touch-screen graphic display, the user interface can be installed recessed from the front or flush with the panel thus making it fit perfectly with the design of the unit.

1.2 Models available and hardware features

The table below shows the technical features of the models available and the purchasing codes.

	Vcolor 368 M & L with J/K thermocouples	Vcolor 368 M & L with Pt 100 2 wire
Power supply		
12 VAC	•	•
Analogue inputs		
Chamber probe	J/K thermocouples	Pt 100 2-wire
Needle probe	J/K thermocouples	Pt 100 2-wire
Boiler probe	J/K thermocouples	Pt 100 2-wire
Fume probe	J/K thermocouples	Pt 100 2-wire
Digital inputs (for normally open/normally closed contact)		
Door switch	•	•
Fan thermal switch (230 VAC)	•	•
Thermal switch (230 VAC)	•	•
Power consumption (230 VAC)	•	•
Boiler water minimum level	•	•
Boiler water maximum level	•	•
Analogue outputs		
0-10 V (fan)	•	•
Digital outputs (electro-mechanical relays; A res. @ 250 VAC)		
Heating	1 A	1 A
Air vent	1 A	1 A
Direct steam injection	1 A	1 A
Chamber light	4 A	4 A
Electronics compartment fan	1 A	1 A
Configurable (default fan direction anti-clockwise) (1)	1 A	1 A

Configurable (default fan direction clockwise) (1)	1 A	1 A
Configurable (default fan speed) (1)	1 A	1 A
Suction hood	1 A	1 A
Configurable (default washing water valve) (2)	1 A	1 A
Configurable (default washing liquid detergent injection) (2)	1 A	1 A
Configurable (default washing liquid discharge) (2)	1 A	1 A
Configurable (default rinse aid injection) (2)	1 A	1 A
Communications ports		
RS-485 MODBUS	•	•
USB	•	•
Other features		
Clock	•	•
Alarm buzzer	•	•
Fan management in both "on/off" and modulating modes, with inversion of the fan direction	•	•
Washing management with detergents in both liquid and tablet form	•	•
"Weekly programmed switch-on" function	•	•
"Programs" function	•	•
Wi-Fi connectivity for remote management through the EPoCA portal (with module EVlink Wi-Fi EVIF25SWX)	•	•

Notes

(1) configurable for:

- fan management in "on/off" and single speed mode
- fan management in "on/off" and single speed mode and with inversion of the fan direction
- fan management in "on/off" and two-speed mode and with inversion of the fan direction
- fan management in modulating mode and with inversion of the fan direction

(2) configurable for:

- washing management with liquid detergent
- washing management with tablet detergent.

Optional extras

None

For more information see the section 18 "TECHNICAL SPECIFICATIONS".

The table below shows the purchasing codes.

Purchasing codes	<p>With J/K thermocouples EVCMC36DJ2E (flush installation); EVCMC36DJ2EF (semi-recessed installation): Vcolor 368 M (kit with control module + 5" user interface)</p>
	<p>EVCLC36DJ2E (flush installation); EVCLC36DJ2EF (semi-recessed installation): Vcolor 368 L (kit with control module + 7" user interface)</p>
	<p>With Pt 100 2 wire EVCMC36DC2E (flush installation); EVCMC36DC2EF (semi-recessed installation): Vcolor 368 M (kit with control module + 5" user interface)</p>
	<p>EVCLC36DC2E (flush installation); EVCLC36DC2EF (semi-recessed installation): Vcolor 368 L (kit with control module + 7" user interface)</p>
	<p>Options EVCLE305XXE: boiler module EVCLE302XXE: burner module EVIF25SWX: EVlink Wi-Fi module</p>

For more models contact the EVCO sales network.

2 INSTALLATION

2.1 Format features

The control module is available in a split version with an open frame board. User interfaces are available in 5 or 7-inch versions for vertical operation and have capacitive colour TFT touch-screen graphic displays.

2.2 Measurements and installation

Control module

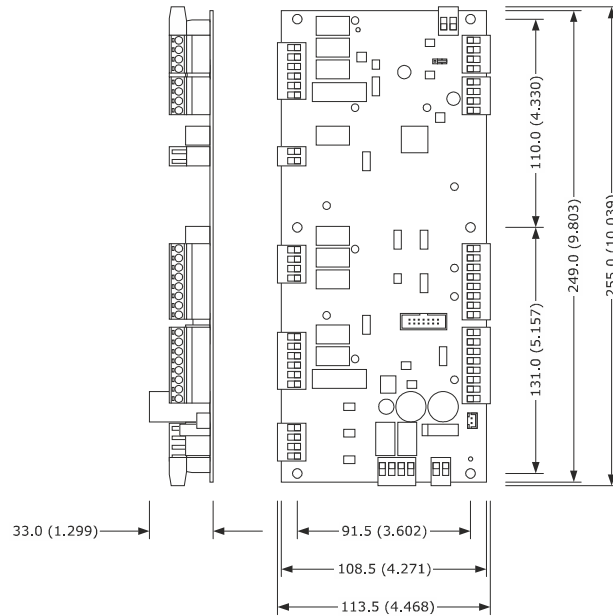

Installation of the control module is on a flat surface with spacers.

5-inch user interface

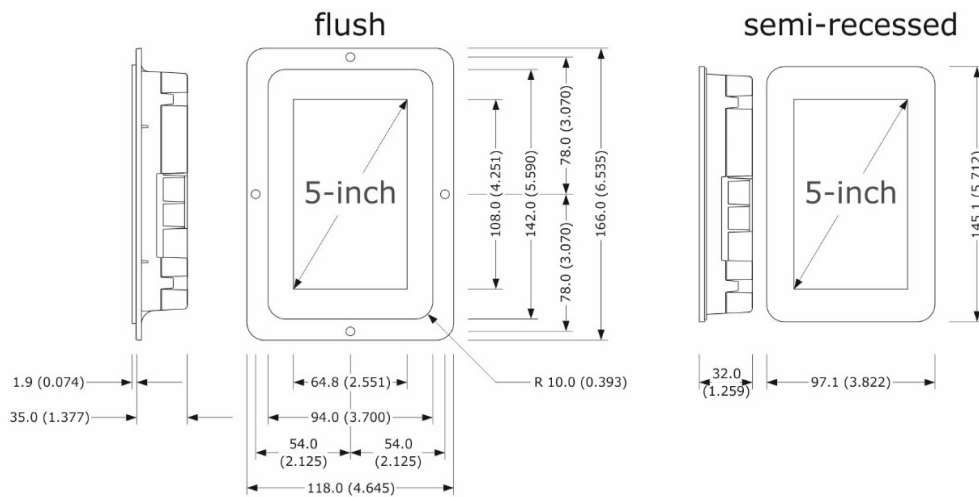

7-inch user interface

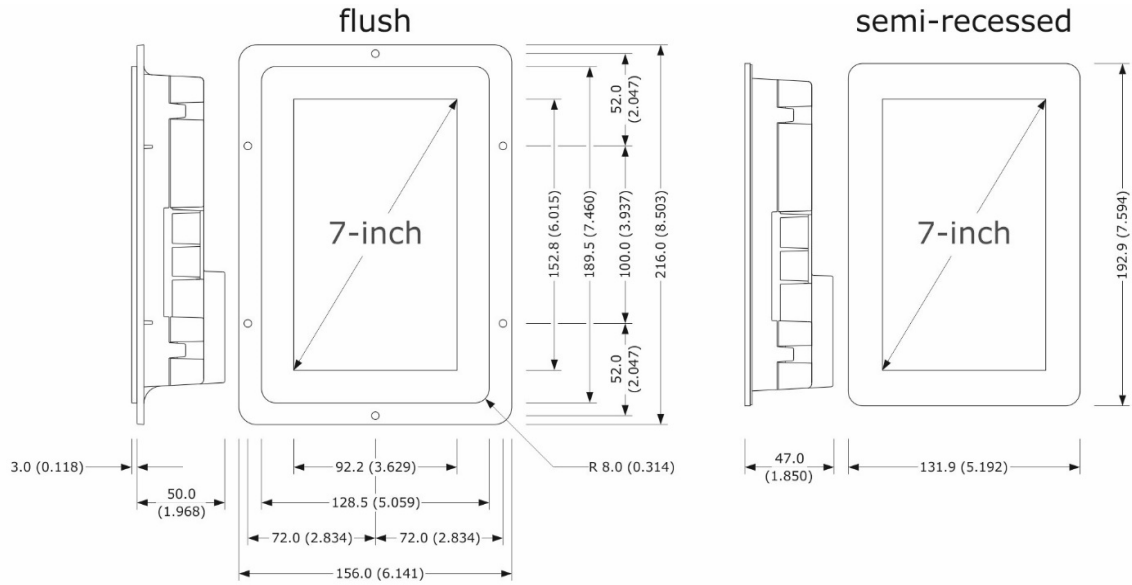

Depending on the model, installation can be:

- flush, from behind the panel with threaded studs (not provided) welded to hold it in place;
- semi-recessed, from the front of the panel with spring clips to hold it in place.

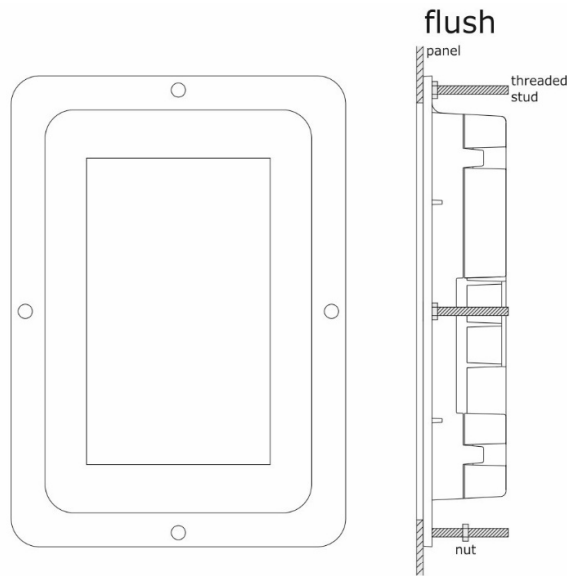

semi-recessed

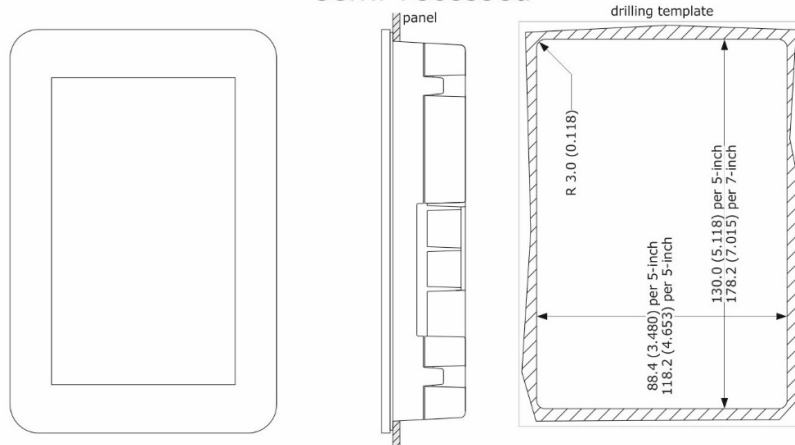



Installation precautions

- ensure that the working conditions for the device (operating temperature, humidity, etc.) are within the set limits. See section 17 TECHNICAL SPECIFICATIONS.
- do not install the device close to heat sources (heaters, hot air ducts, etc.), equipment with a strong magnetic field (large diffusers, etc.), in places subject to direct sunlight, rain, damp, excessive dust, mechanical vibrations or shocks.
- any metal items close to the control module must be at a sufficient distance so as not to compromise the safety distance; any cabling must be placed at least 2 cm away.
- in compliance with safety regulations, the device must be installed properly to ensure adequate protection from contact with electrical parts. All protective parts must be fixed in such a way as to need the aid of a tool to remove them.

2.3 Vcolor 368M electrical connection

The picture below shows the electrical connection of devices with a 5-inch user interface.

For more information on how to manage ventilation see subsequent pictures.

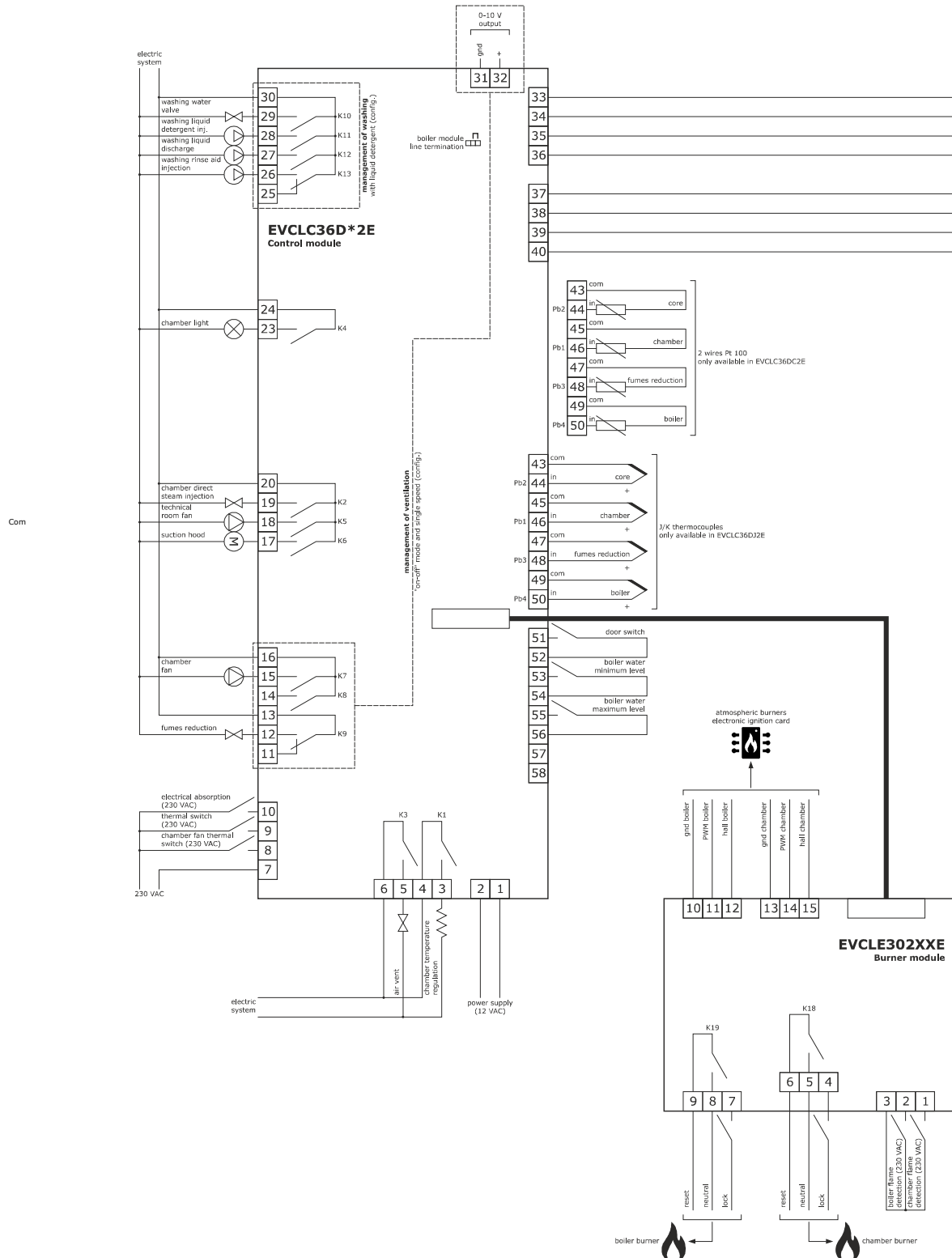

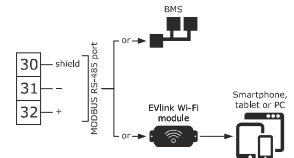
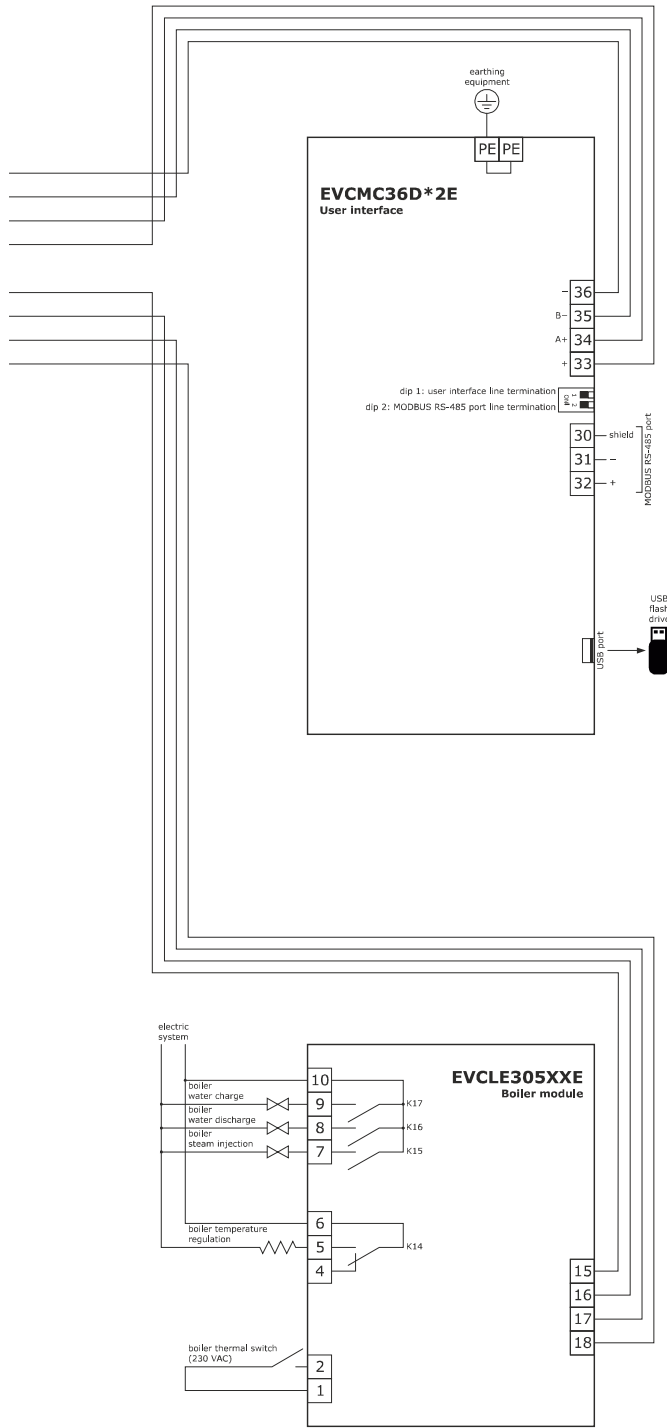

2.4 Vcolor 368L electrical connection

The picture below shows the electrical connection of the device with a 7-inch user interface.

For more information on how to manage ventilation see subsequent pictures.

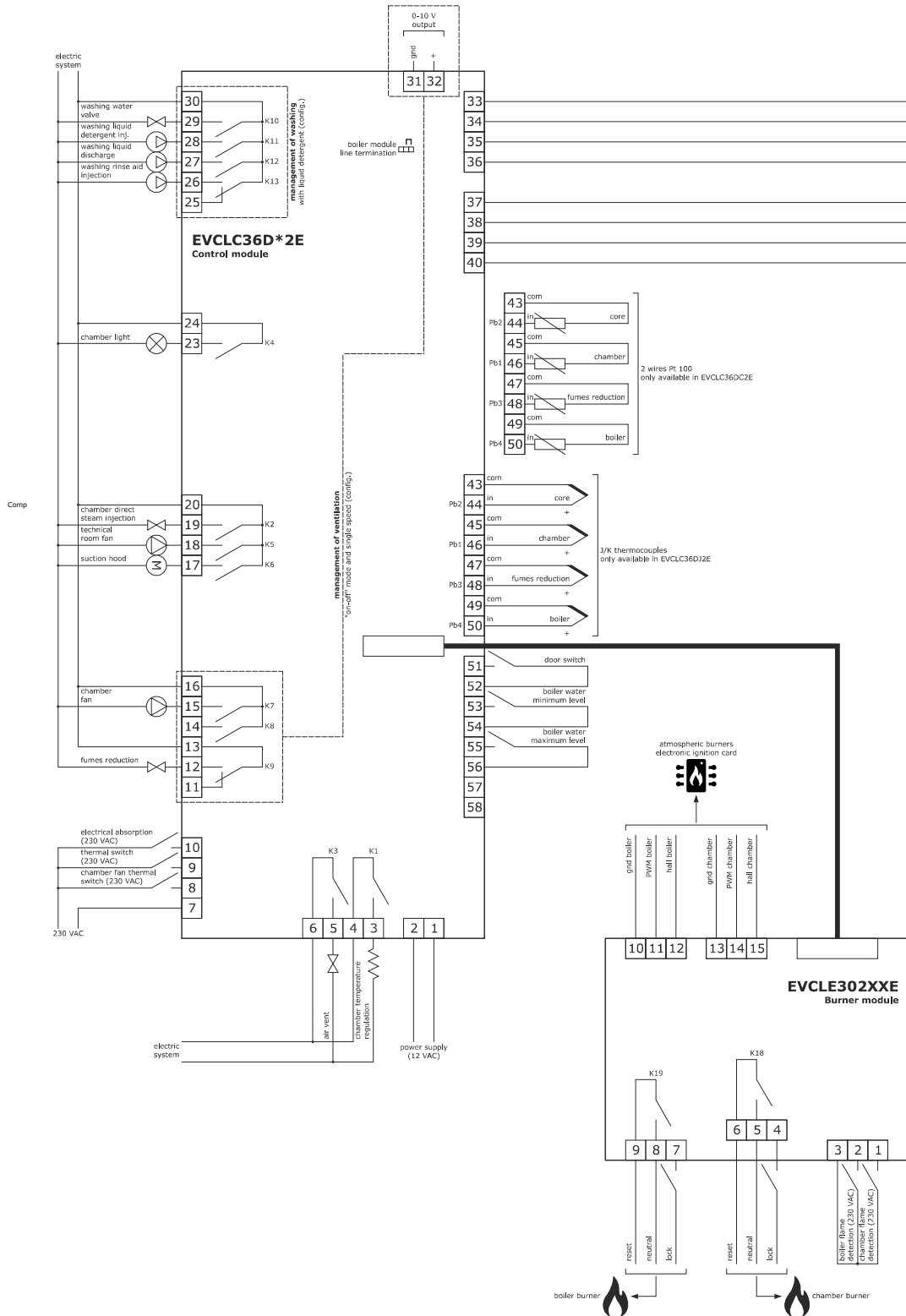

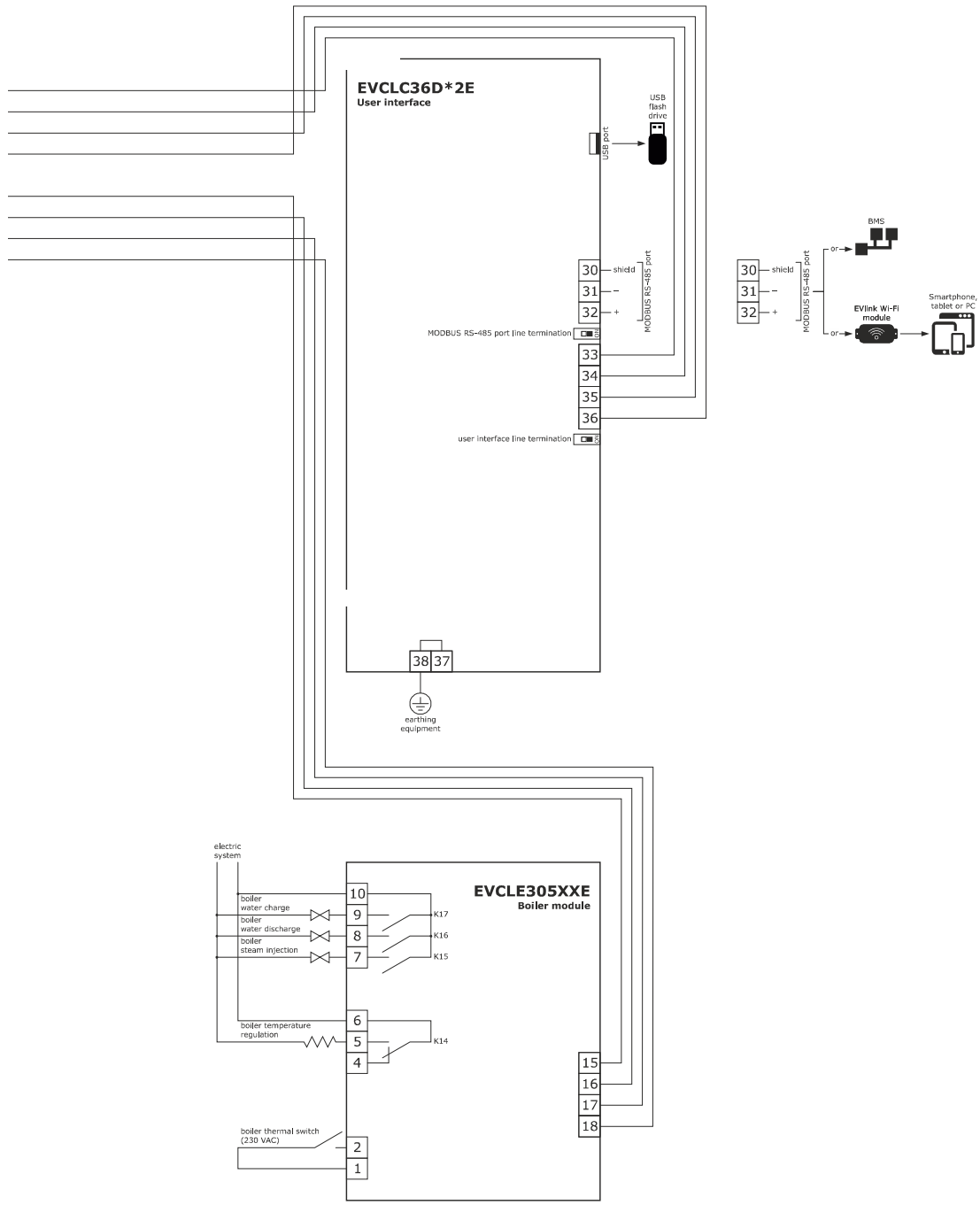

Fan management in "on/off" and single speed mode (parameter F0 = 0)

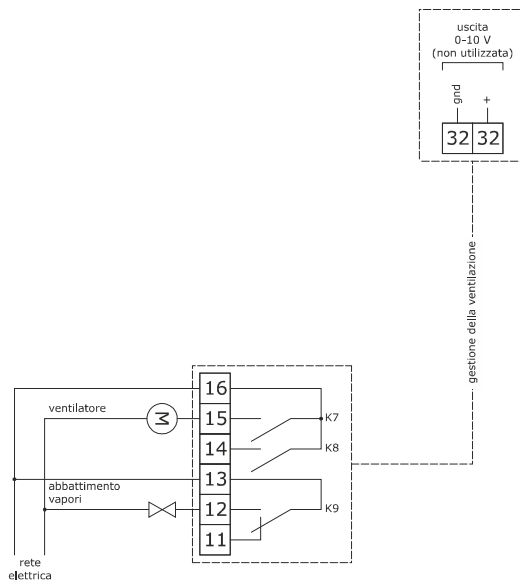

Fan management in "on/off" and single speed mode and with inversion of the fan direction (parameter F0 = 1)

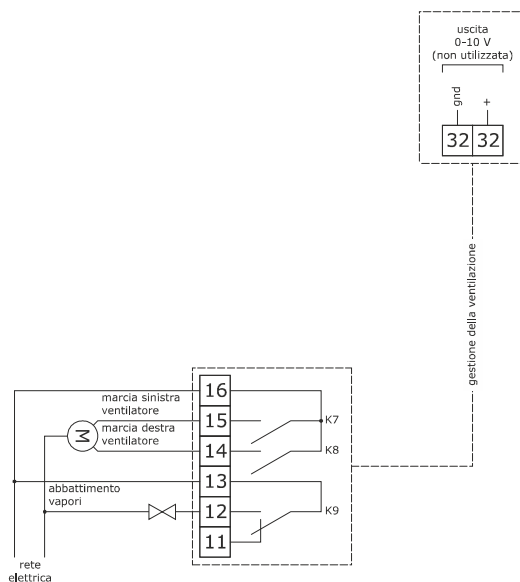

Fan management in "on/off" and two-speed mode and with inversion of the fan direction (parameter F0 = 2)

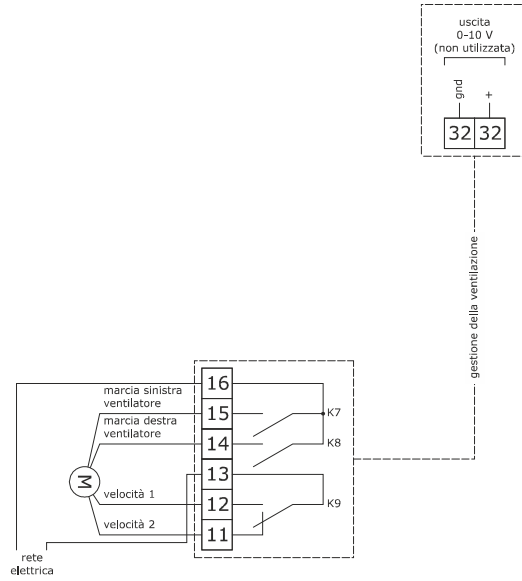

Fan management in modulating mode and with inversion of the fan direction (parameter F0 = 3)

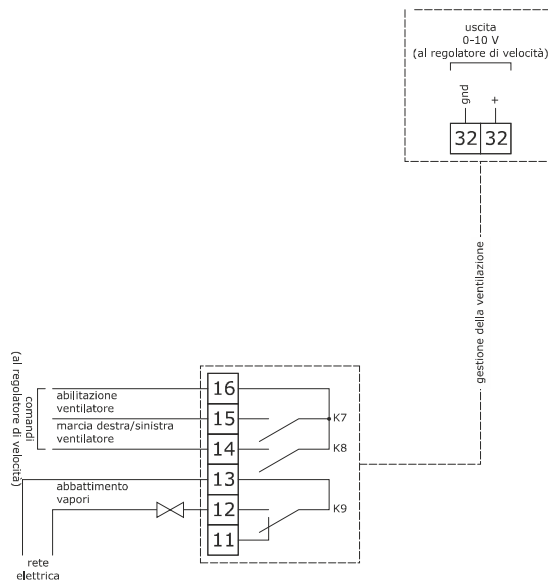

The RS-485 MODBUS communications port enables connection to the Parameters Manager set-up software.

The USB communications port makes it possible to upload and download the device settings using an ordinary USB flash drive.

Example of connection of a motorised venting solenoid valve.

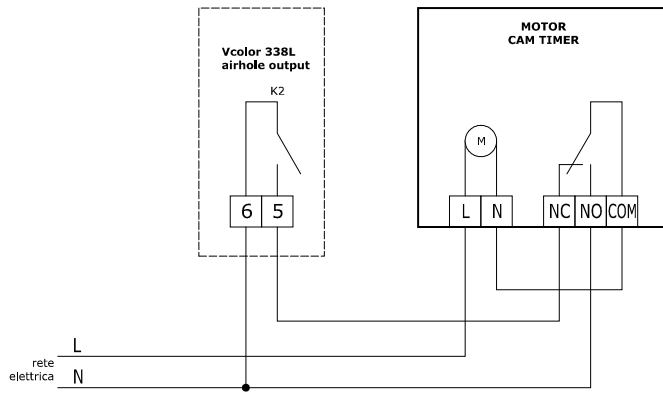

The following diagram and the following timings are an example of the way the "FIBER" venting mechanism type can be operated. $u_2 = 120$ (12 seconds) pause time for cam to run $u_3 = 10$ (1 second) motor activation time for short milling output $u_4 = 30$ (3 seconds) motor activation time for long milling output

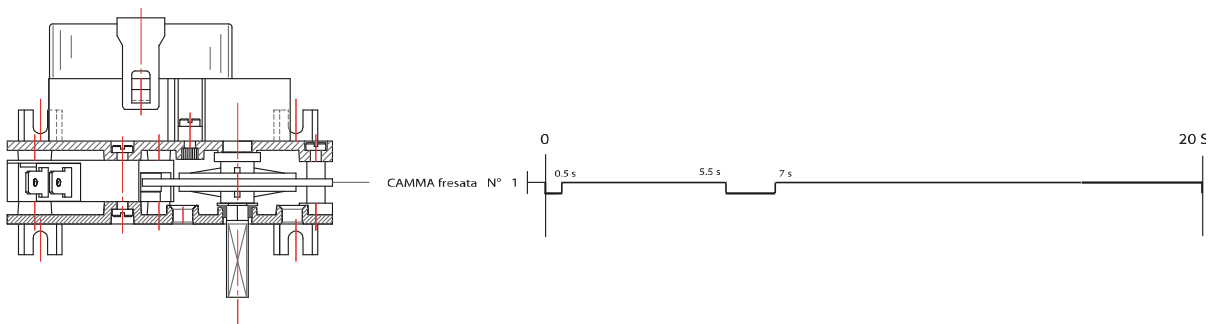

The following diagram and the following timings are an example of the way the "METEOR" venting mechanism type can be operated. $u_2 = 120$ (12 seconds) pause time for cam to run $u_3 = 15$ (1.5 seconds) motor activation time for short milling output $u_4 = 50$ (5 seconds) motor activation time for long milling output

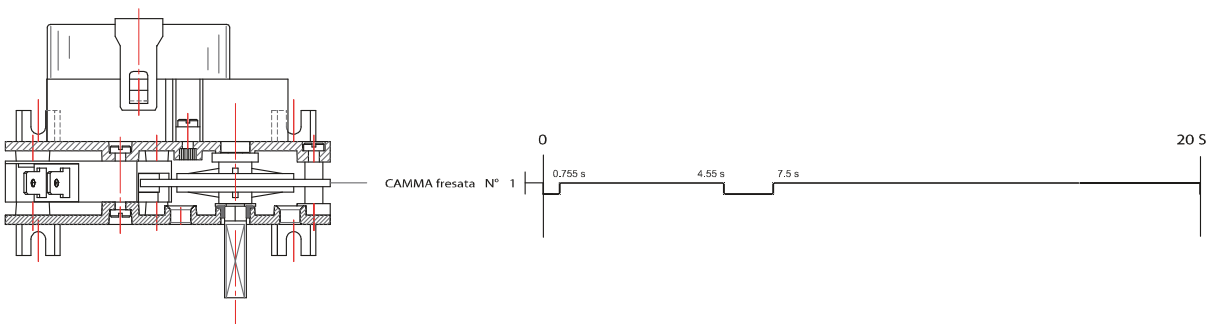

Details of EVlink Wi-Fi electrical connection to Vcolor 368M

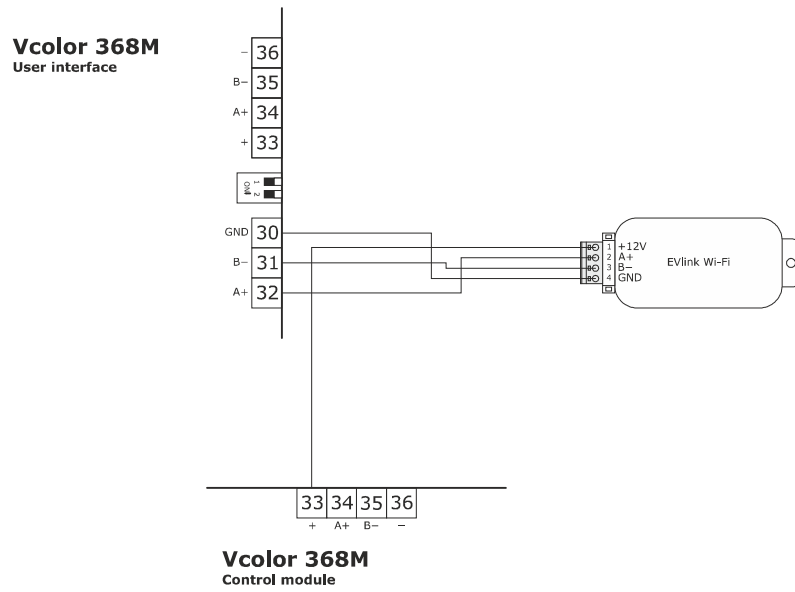

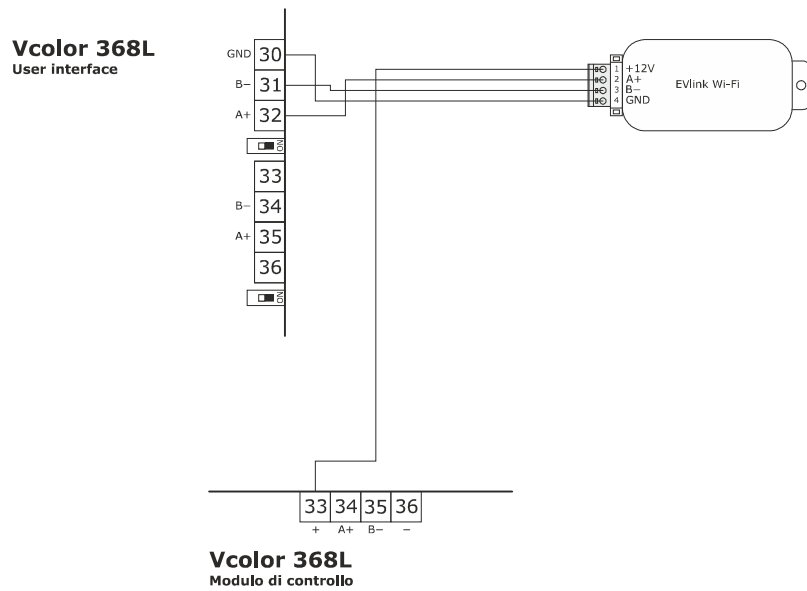

Details of EVlink Wi-Fi electrical connection to Vcolor 368L



3 OPERATING THE DEVICE

3.1 Switching the device on/off

After having connected the power to the device, wait for the system to load. On the Stand-by page, touch the  icon in the centre to access the Home page. To switch off the device, make sure that there are no processes running and then touch the  icon that appears below.

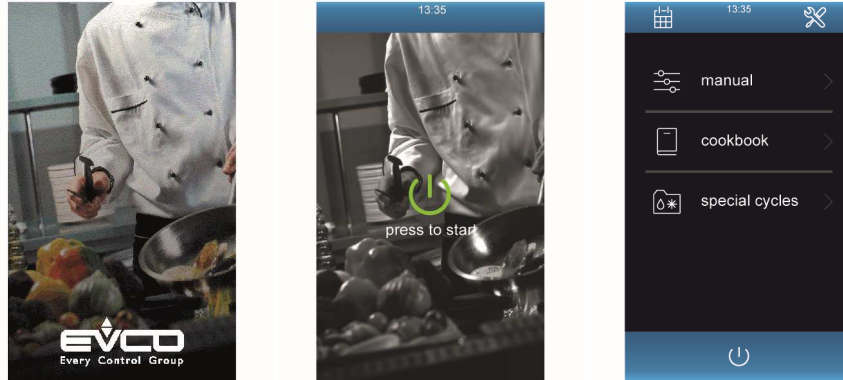

NB: if boiler expansion is enabled, the water loading relay is switched on when the device is switched on and the water discharge relay is switched on when the device is switched off.

3.2 Power failure

If the power supply is interrupted when the device is switched on or off, when power is restored the device will return to the status before the interruption.

If the power supply is interrupted during a cooking cycle and the interruption lasts for a shorter time than that set by parameter r12, when power is restored the cycle will be resumed from the start of the phase in which the power failed (if the interruption lasts longer than the time set by parameter r12, the cycle will be interrupted when power is restored).

3.3 Silencing the buzzer

To silence the buzzer, proceed as follows.

1. Ensure that no procedure is in progress.
2. Touch the  area

4 NAVIGATION

4.1 Initial information

From the Home page it is possible to access the 3 macro categories of cycles, in addition to the settings and weekly planning functions. Just touch the corresponding area on the screen.

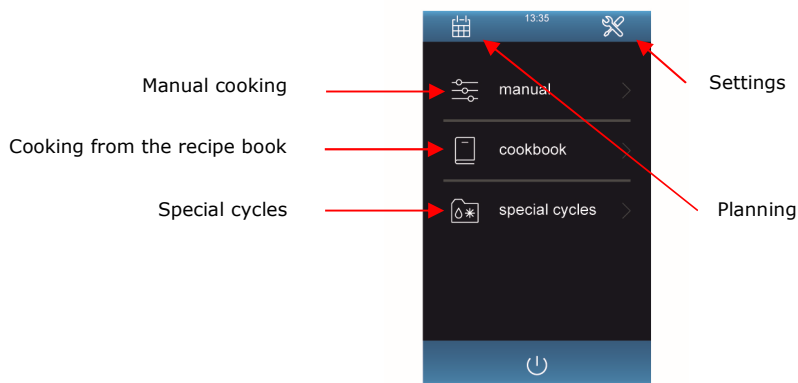

Below is an overview of the pages and the icons used and their description. For more information on the functions, see the sections below.

4.2 Manual cooking

Cooking can be by convection , steam  or mixed . The default setting is mixed cooking.

The control method is timed, core temperature or Delta T.

The "pre-heating" function can be activated manually, provided that Delta T cooking has not be selected.

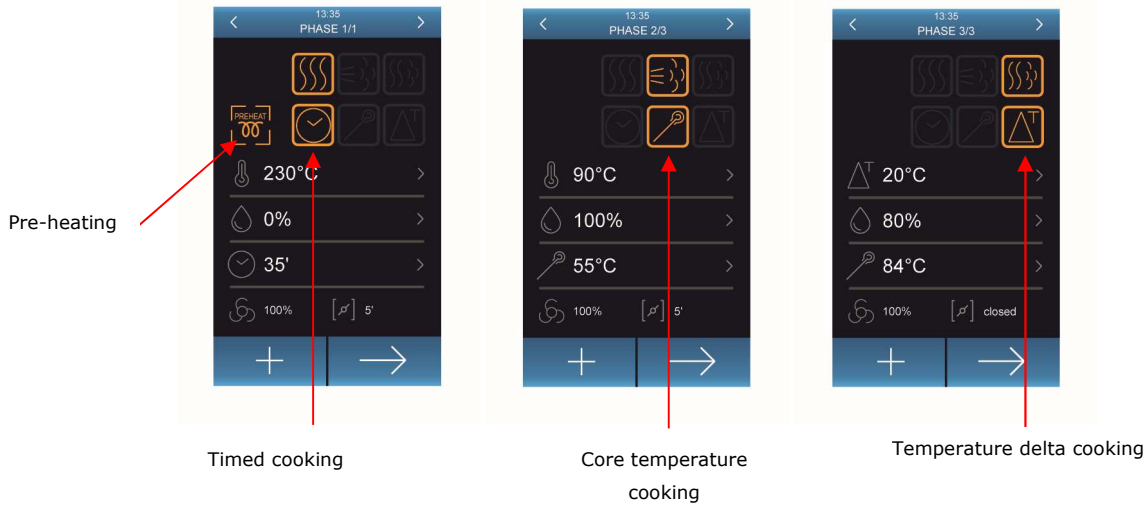

4.3 Cooking from the recipe book

In the "recipe book" section, it is possible to retrieve preloaded "OEM" recipes grouped into categories or "my recipes" saved by the user.

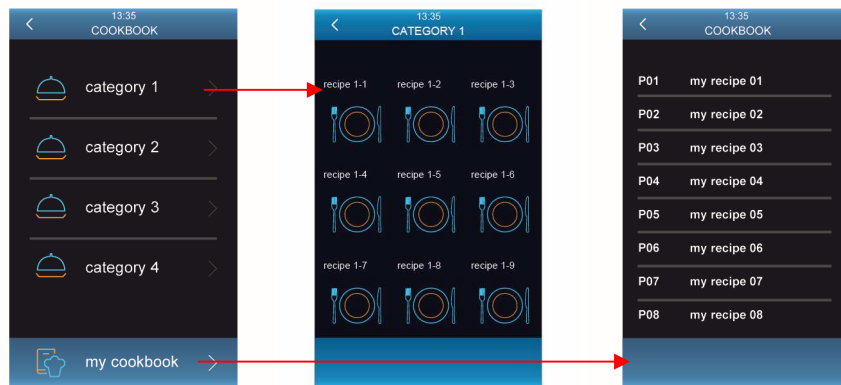

4.4 Special cycles

In the "special cycles" section it is possible to access functions connected to cooking (à la carte cooking, regeneration and resting) and to particular cycles such as cooling and washing.

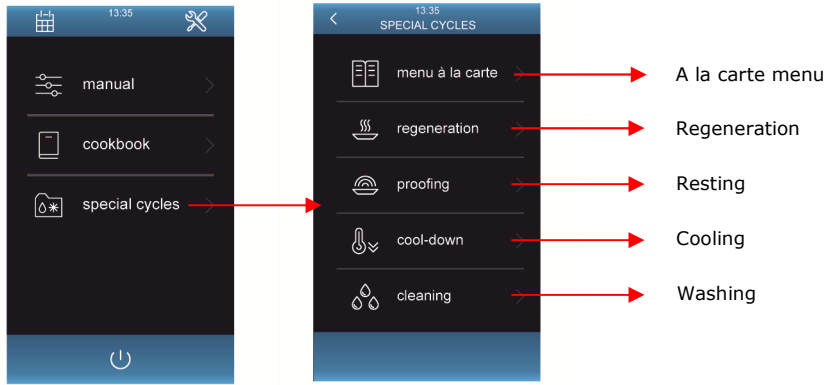

4.5 Settings and status

The settings and status menu can be accessed from the home page by touching the  icon at the top right.

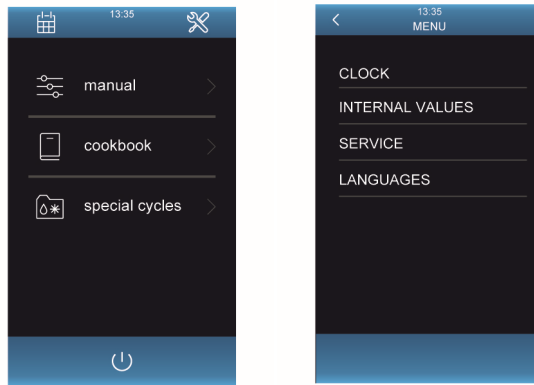

4.5.1 Clock

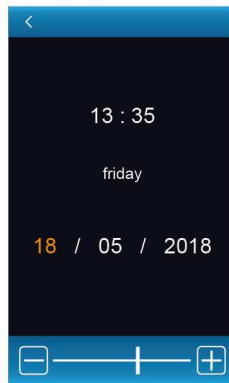

To modify a value, touch the corresponding area: the value will appear in a different colour to indicate that it can be modified. At this point, use the bar at the bottom to increase or decrease the value as desired and touch the value again to confirm the change.

4.5.2 Internal status

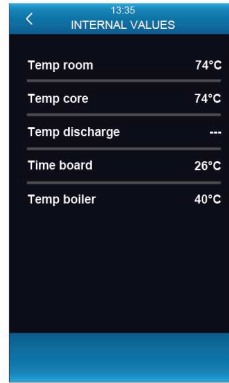

The screen displays just the main status of the unit. To display all the internal status data, the password +19 must be entered on the SERVICE screen. SERVICE log-in access privileges will be retained until the device is powered off.

4.5.3 Service

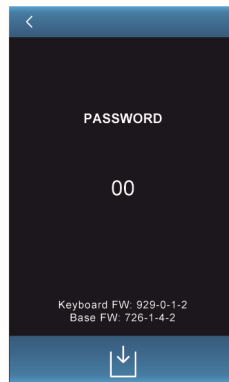

From this screen, in addition to the password +19 for the extended display of internal status data, the password -19 can be entered to access the configuration parameters with privileges to modify their values.

4.5.4 Languages

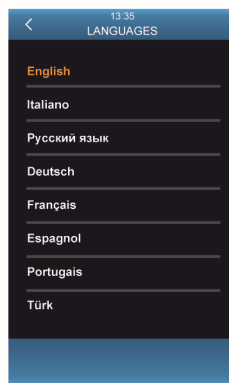

This screen gives the option to select one of the languages offered for the user interface.

5 Planning

The weekly programmed switch-on can be accessed from the home page by touching the  icon at the top left.

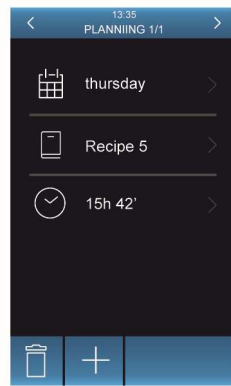
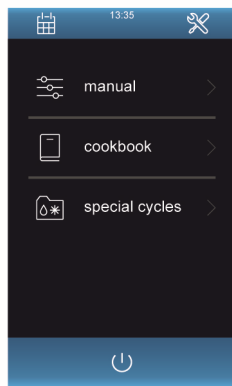

6 COOKING FUNCTION

6.1 Initial information

Cooking can be by convection, steam or mixed. Each cooking cycle consists of a minimum of one up to a maximum of six phases. At the end of each phase the device automatically moves on to the next one. The device can be used to manage the settings listed below for each phase:

Pre-heating

Each cooking cycle can be preceded by a period of pre-heating, if selected by the user during the cycle setup, provided that Delta T cooking has not been selected, which by its nature does not provide for pre-heating.

The pre-heating setpoint is relative to the working setpoint during the first phase of the cooking cycle, i.e. the "working setpoint during the first cooking cycle phase + working setpoint during pre-heating (r10)".

During pre-heating the fan is switched on at maximum speed and humidification remains the same as in the first phase of the cooking cycle. When the temperature detected by the chamber probe reaches the working setpoint, the buzzer sounds for 2 seconds.

Opening and closing the door sets off the first cooking cycle phase.

Timed cooking

The working setpoint is an absolute value and the phase may last for the preset time or for an unlimited time ("∞").

Delta T cooking

This can only be set if the needle probe is connected; the controller is able to recognise it automatically.

The phase lasts until the temperature detected by the needle probe reaches the core setpoint and the working setpoint is relative to the temperature detected by the needle probe, i.e. "temperature measured by the needle probe + Delta T setpoint".

With this type of cooking, HOLD mode can be activated by setting the delta T value to 0° C (the word "HOLD" will appear): in this way the unit will keep the chamber at the same temperature as the needle probe indefinitely.

Core temperature cooking

This can only be set if the needle probe is connected; the controller is able to recognise it automatically.

The phase lasts until the temperature detected by the needle probe reaches the core setpoint and the working setpoint is an absolute value.

Working setpoint

This can be set only if timed cooking or core temperature cooking has been selected.

Delta T setpoint

This can be set only if Delta T cooking has been selected.

Humidification

This can be set only if steam or mixed cooking has been selected.

For settings relating to humidification, please see the section "List of configuration parameters" in the section on steam injection (parameters t0 to t40).

Duration of the phase

This can be set only if timed cooking has been selected.

Core temperature setpoint

This can be set only if Delta T or core temperature cooking has been selected.

Fan speed

This can only be set if fan management is set to "on/off" two-speed mode or modulating mode, i.e. if parameter F0 is set to 2 or 3.

Duration of automatic vent opening

Since it relates to the time prior to the conclusion of the phase, it can only be set if timed cooking has been selected.

With regard to core temperature and Delta T cooking, it is possible to select whether the vent will be opened or closed during the cooking cycle.

6.2 Method of operation for ventilated bread and pastry-making ovens

By configuring the parameters appropriately, the controller set-up can be adapted to enable management of ventilated bread and pastry-making ovens. Specifically:

t1 = 1000 enables a single injection of steam to be carried out at the beginning of the cooking cycle (with a delay time defined with t3 and/or t8)







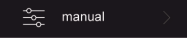

t29 = 1 enables the steam injection time to be displayed in seconds (instead of a percentage)

t31 > 0 enables the fan to be switched off both during the entire steam injection and following the steam injection for the time period t31

6.3 Setting the cooking cycle

Ensure that the device is switched on and that no procedure is in progress, and then proceed as described below:

To set the cooking type:

- Touch the  area
- Touch  to enable/disable pre-heating
- Select the type of cooking desired:
 - convection cooking 
 - steam cooking 
 - mixed cooking 
- Select the type of control desired:
 - timed cooking 
 - Delta T cooking 
 - core temperature cooking 

To set the various working setpoints:

- Touch the value to be modified
- Touch the slide bar 
- Touch the value to confirm the setting.

To set the fan speed:

- Touch the  icon and select the desired speed



To set the status of the venting during cooking or the amount of time to be set for the vent to open in advance before the end of the phase:

- Touch the  icon and select the desired value

To select/scroll through the cooking cycle phases:

- Press the arrows at the ends of the status bar at the top of page 

To add a cooking cycle phase:

- Press  "add phase" on the bar at the bottom of the page 

To delete the last phase of the cooking cycle:

- Select the phase to be deleted using the arrows at the top (note: it is only possible to delete the last phase)
- Press "Delete phase" 

To end the setting of a programme:

- From any of the phases making up the cycle, press "End recipe" 

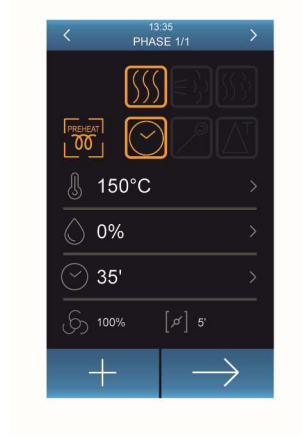

Selecting pre-heating, type of cooking and method of phase control.

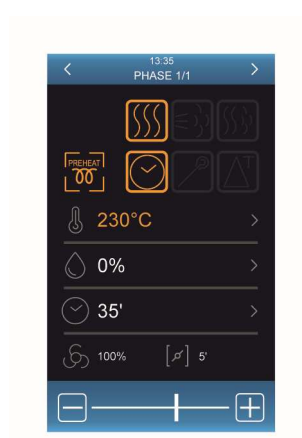



Setting the working setpoint.



Adding/deleting phases, ending recipe

Once the programme has been set, the controller will show a screen summarising the cycle settings.

From this screen it will be possible to:

- Go back to setting the cycle using the arrow at the top left.
- Save the cycle by touching the  icon
- Execute the cycle by touching 

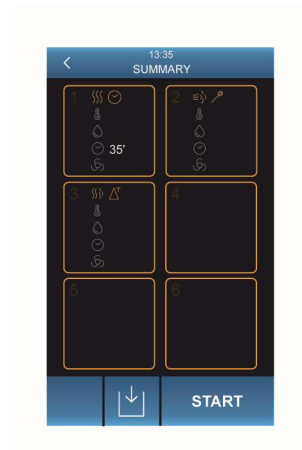

Cycle summary screen

NB: The duration of a cycle for which the preset time is indefinite cannot be changed during cooking.
 The duration of a non-indefinite time controlled cycle may be changed during cooking, but it cannot be changed to indefinite.

6.4 Starting/interrupting the cooking cycle

Once the cooking cycle has started, pre-heating will start, if selected.

Opening or closing the door or pressing the status bar starts off the first phase of the cooking cycle.

During pre-heating and during the cooking cycle, the display shows the value of the variables involved in the process and their settings.

All working setpoints can be changed at any time. You can also press:



 VENT to open/close the vent manually

 LIGHT to switch the light on/off manually

INFO to view the values of process variables and machine status data

On completion of the cooking cycle, the buzzer is activated for the length of time set by parameter c0. To interrupt the cooking cycle manually, press STOP for one second.

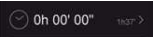
To extend the cooking cycle, proceed as follows:

- Touch 
- Touch  to set the desired value.
- Touch the screen to confirm the setting.



Startup of the cooking cycle and Pre-heating

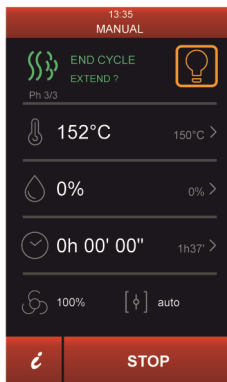

End or interruption of the cooking cycle

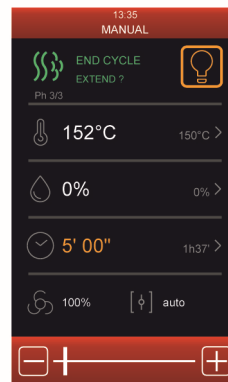

Extending the cooking cycle

7 "RECIPE BOOK" FUNCTION

7.1 Initial information

The controller provides for two types of recipe book:

"OEM" Recipe Book

It is a space into which up to 4/8 categories of recipes can be loaded via USB, each consisting of a maximum of 9 recipes, complete with a NAME TRANSLATED INTO OTHER LANGUAGES and a product PHOTO of a size of 140x140px.

This function is primarily for the benefit of OEM/DISTRIBUTORS who can load their recipe books themselves for use by their own clients.

For details of the procedure illustrating how to set up the OEM recipe book, please contact the EVCO sales network.

My recipes





This recipe book is for the use of end users who will be able to save the settings of personalised cooking cycles in a recipe. When a recipe is started up the device uses the settings stored. A new recipe will be integrated into the "My recipes" menu with a name that can only be entered in the Western alphabet and will not be translated.

My recipes can only be stored by the controller.



7.2 Storing "My recipes"

A maximum of 48 "my recipes" and 72 "OEM recipes" can be stored.

After having entered the settings for the cooking cycle as explained in the paragraph "Setting the cooking cycle", put the device into the "Cycle details" status and store a recipe as follows:

- Press : the "My recipes" page will open and display a list of the available positions (marked with "---") and any previously saved recipes
- Scroll down the page and select the position where you want to save a new recipe or overwrite an existing one
- Press  to confirm the selection: the alphabetic keyboard will be displayed (touch  to exit the process without saving)
- Type the name of the recipe to be stored and press  to confirm

To change the name of a recipe, proceed as follows:

- Touch the recipe name to be changed
- Touch V to confirm that you wish to make the amendment: the alphabetic keyboard will be displayed (touch  to exit the process without saving)
- Use the  key to cancel the name displayed and type the new recipe name
- Press  to confirm

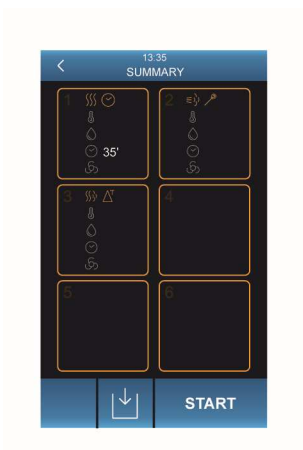

"Cycle details" screen for accessing "My recipes"



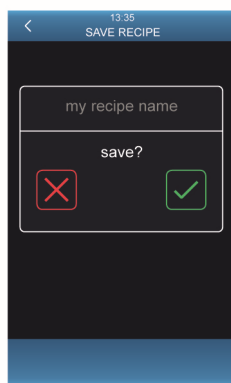

"My recipes" screen



Recipe name change screen

7.3 Starting up a recipe

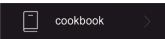
To start up a recipe, proceed as follows:

- Ensure that the device is switched on and that no procedure is in progress.
- Touch the key .
- Select the OEM recipe category and then the desired recipe, or enter the  menu and select the recipe desired.
- On the "Cycle details" page touch  to start the recipe.
- If you want to change recipe data, touch EDIT to enter the recipe settings.

7.4 Deleting a recipe

To delete a recipe, proceed as follows:

1. Select the recipe you wish to delete from the "My recipes" list and press the  key.

8 SPECIAL CYCLES FUNCTION

8.1 Initial information

The "Special cycles" function lets you take advantage of ready-to-use work cycles.

You can start one of the following work cycles:

- core temperature/timed regeneration cycle
- timed proofing cycle
- chamber cooling cycle
- "à la carte" cooking cycle in count-up or count-down mode
- chamber washing cycle

The factory settings for these cycles are set out below.

Core temperature regeneration

SETTING	DEFAULT	MINIMUM... MAXIMUM
working setpoint	110 °C	20... 180 °C
humidification	70%	40... 100%
core temperature setpoint	70 °C	20... 100 °C
fan speed	minimum	
opening of the vent	at the end of the cycle	

Timed regeneration

SETTING	DEFAULT	MINIMUM... MAXIMUM
working setpoint	110 °C	20... 180 °C
humidification	70%	40... 100%
duration of the phase	25 min	∞... 90 min
fan speed	minimum	
opening of the vent	at the end of the cycle	

Timed proofing (it is possible to set a second phase)

SETTING	DEFAULT	MINIMUM... MAXIMUM
working setpoint	30 °C	20... 50 °C
humidification	80%	40... 100%
duration of the phase	120 min	1... 300 min
fan speed	minimum	
opening of the vent	at the end of the cycle	

Chamber cooling (with door open/closed)

SETTING	DEFAULT	MINIMUM... MAXIMUM
working setpoint	50 °C (r11)	0... 300 °C
fan speed	minimum, without inversion of direction (if provided for)	
opening of the vent	at the start of the cycle, for its entire duration	

8.2 "À LA CARTE" cooking cycle

The "à la carte" cooking cycles allow the oven to cook simultaneously trays with different dishes and with different cooking times but of the same cooking types (for the temperature and humidity settings).

There are two types of "à la carte" cooking cycles:

COUNT-UP



This is a cycle type used primarily during the preparation of "cooking lines" for restaurant services. To all intents and purposes it is a "continuous" cooking process.

Trays with different products are loaded at the same time or at different times in the oven and each completes its cooking at its own independent time. Thereafter, other trays can be added with other types of products, again with different cooking times.

The controller will indicate both visually and with a buzzer which timer has completed cooking, thus drawing the user's attention to the tray that is ready.

When all of the trays have been cooked, the oven will maintain its temperature until stopped manually.

COUNT-DOWN



This is a cycle type used primarily during restaurant service. Trays with different cooking/resting times all complete their cooking simultaneously so that the dishes can be served to the table at the same time.

The controller will indicate both visually and with a buzzer when to load each tray starting with the tray with the longest cooking time.

In this way, the cooking of all the trays specified in the cooking cycle will end at the same time, at which point the oven will signal the end of the cooking cycle and will maintain its temperature until stopped manually.

During the setting up of an "à la carte" cycle, the oven temperature and humidification level will be established either manually by the user or by the set up of TRAY 1 in the recipe book (single phase recipes only).

Setting the cooking times of all the other trays can be carried out either manually or by retrieving other recipes from the recipe book. The recipes that can be used will only be those compatible in terms of temperature and humidity (with a percentage tolerance established by parameter) with the recipe set for TRAY 1; those that are not compatible will automatically be hidden.

Confirmation of the removal (by count-up) or loading of the tray indicated by the controller is provided automatically with the opening and closing of the door.



Screen for setting the cooking type/temperature/humidity/ventilation for the entire cycle. Alternatively, the recipe can be retrieved from the recipe book.

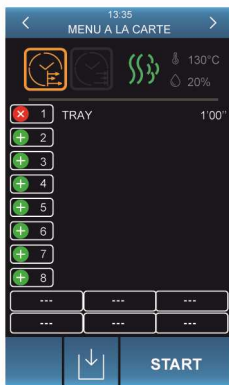

Selecting COUNT UP or COUNT DOWN mode



À LA CARTE - COUNT DOWN cycle in progress

9 "WEEKLY PROGRAMMED SWITCH-ON" FUNCTION

9.1 Initial information

The "Weekly Programmed Switch-on" function makes it possible to programme the device to start up a maximum of 9 times a week and at the same time to start up a recipe.

9.2 Setting the "Weekly programmed switch-on" function

To access this procedure, proceed as follows:

1. Ensure that at least one recipe has been saved, that the device is switched ON and that no other process is in progress.
2. Touch the PLANNING key.
3. Enter the startup day and time and the recipe to be executed on programmed switch-on.
If the selected program includes a preheating phase, the controller will remain in pre-heating mode until the trays have been in the oven for a time of c2, after which the device will be switched off.
If the selected programme does not include pre-heating, the controller will carry out the required cooking cycle immediately.

9.3 Activating the "Weekly programmed switch-on" function

To access this procedure, proceed as follows:

1. Ensure that at least one switch-on event has been set, that the device is switched on and no other procedure is in progress.
2. Put the controller into STAND-BY.
3. The controller will offer the first programmed switch-on available in time order; the activation day and time can be changed temporarily or one of the other programmed switch-ons can be selected.
4. Select whether to turn off the device either without or with a scheduled switch-on. In the latter case, the day, time and programme for the next automatic switch-on will appear on the stand-by screen.

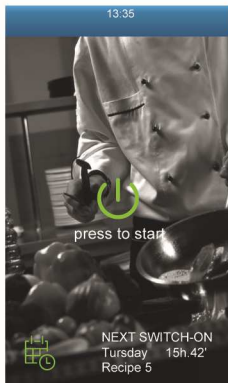

Access to the function settings

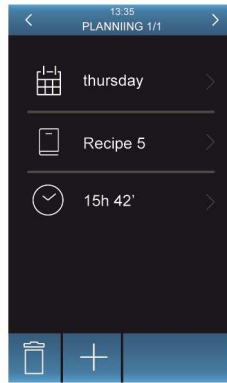

Setting the day, time and recipe for the planned switch-on

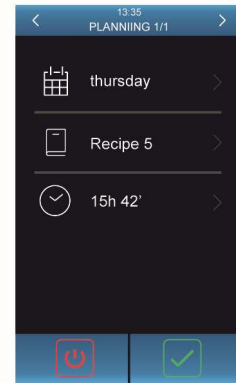

Select the desired planned switch-on and confirm.

10 BOILER EXPANSION

10.1 Activating expansion

The following conditions must be met to enable EVCLE305XXE boiler expansion:

1. Enable the boiler by setting parameter T15 (T15 = 1)
2. Set the steam generation mode with external or mixed humidification by setting parameter T0 (T0 = 1 or 2)
3. The boiler temperature probe can be enabled/disabled by parameter, without affecting boiler operation.

There are in fact some types of boilers where it is possible to check the water temperature while there are others that either already have a built-in check by means of a pressure switch or that do not have any type of check as they are not pressurised but open boilers in which steam enters the cooking chamber naturally.

In cases where the boiler probe is disabled, there will obviously be no checks on the temperature of the boiler before the injection of steam is allowed. When a cooking phase is provided for with steam injection from the boiler, the boiler heater output will always be active.

4. Through parameter t40, it is possible to: enable/disable checking of the minimum/maximum water level, enable only the minimum level or completely disable the check. If the minimum or maximum level digital input is disabled, the related functions will be disabled.

10.2 Electrical connection

Example for Vcolor 368L.

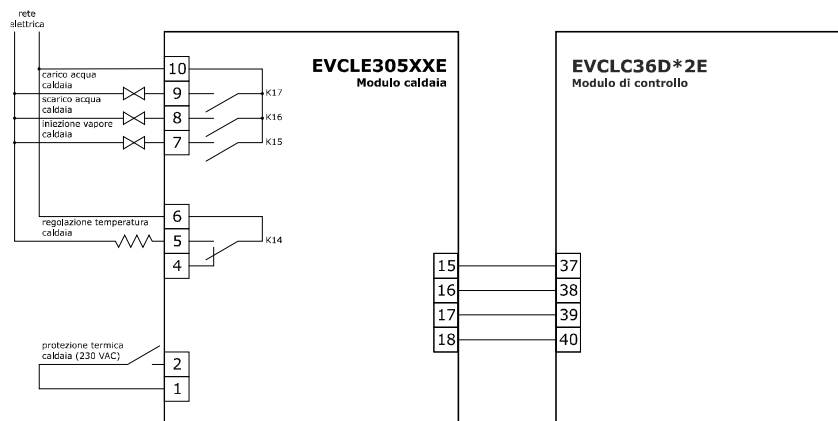

10.3 Operation

10.3.1 Water load management

With the board ON the water is fed in and kept above the maximum level (if the maximum level digital input is enabled).

If the minimum level required is not reached within the prescribed time (parameter t27), the following alarm signal will be activated: "MIN. BOILER WATER LEVEL".

If the maximum level required is not reached within the prescribed time (parameter t28), the following alarm signal will be activated: "MAX. BOILER WATER LEVEL".

These alarms can be reset manually using key , pressing  to reset the alarm and start up a new water loading cycle.

10.3.2 Water heating management

With the board ON the water is heated and kept at "Boiler steam maintenance temperature" (parameter t18). During cooking, or boiler or chamber washing the water is heated and kept at "Boiler steam working temperature" (parameter T17).

This operation is deactivated if there is a lack of water (minimum level not reached) or if the boiler probe is disabled.

In the event that the boiler probe is disabled, the boiler heater will always be active when steam injection is called for.

10.3.3 Boiler rinsing

The BOILER menu can be accessed from the settings menu.

The RINSING function can be selected from the BOILER menu.

When this cycle is started, the following phases will be carried out:

1. Filling with water to the maximum level.
2. Emptying water.
3. Filling with water to the maximum level.
4. Emptying water.

Should the emptying not take place, the "BOILER EMPTYING" alarm will be activated. The alarm can be reset with the  key.

If the maximum level is not reached within the prescribed time (parameter t28), the "MAX. BOILER WATER LEVEL" alarm signal will be activated. The alarm can be reset with the  key.

In the event of a "BOILER EMPTYING" or "MAX. BOILER WATER LEVEL" alarm, the rinsing will stop temporarily until the cause has been eliminated.

To interrupt rinsing, press the STOP key for 4 seconds.

10.3.4 Boiler washing

The BOILER menu can be accessed from the settings menu.

The WASHING function can be selected from the BOILER menu (if t0 <> 0).

When the WASHING key is pressed, a password will be requested (default "1").

By starting this cycle, the following phases will be carried out:

Phase 1 - Preparation

1. Filling with water to the maximum level.
2. Emptying water.

Phase 2 - Washing

3. Request to load anti-scaling agent: loading is carried out manually. To continue press the V key. NB: from this point on it is no longer possible to halt the washing cycle!
4. Filling with water to the maximum level.
5. Anti-scaling activation: this will last for the time set in parameter t22, and the water will be heated to the temperature set in parameter t23.

Phase 3 - Rinsing

6. Emptying water.
7. Filling with water to the maximum level.
8. Washing activation: this will last for the time set in parameter t24, and the water will be heated to the temperature set in parameter t25.
9. Return to step 6. The rinsing phase (steps 6,7,8) will be repeated for the number of times set in parameter t26. Washing ends with the emptying of the water from the Boiler.

Should the emptying fail to take place, the "BOILER EMPTYING" alarm will be activated. The alarm can be reset with the  key.

If the maximum level is not reached within the prescribed time (parameter t28), the "MAX. BOILER WATER LEVEL" alarm signal will be activated. The alarm can be reset with the  key.

In the event of a "BOILER EMPTYING" or "MAX. BOILER WATER LEVEL" alarm, the washing will stop temporarily until the cause has been eliminated.

To interrupt the washing, press the STOP key for 4 seconds.

11 BURNER EXPANSION

11.1 Activating expansion

To enable burner expansion, parameter b14 must be set to:

- 1 where a modulated air blown burner is being used
- 2 where an on-off atmospheric burner is being used

11.2 Managing a modulated air blown burner

If burner expansion is activated, when a request is made to heat the oven, the corresponding burner will be activated instead of the chamber or boiler heater. The power with which the oven will be heated is proportional to the speed of the burner.

The burner activation procedure is as follows:

PRE-VENTILATION PHASE

The burner speed is raised to the value set by parameter b2 (chamber) or parameter b9 (boiler), and is kept constant for 10 seconds.

IGNITION PHASE

After 10 seconds, the stability of the speed is checked by means of the Hall sensor, then the burner control unit is activated by means of the corresponding relay (chamber or boiler heater). Once the presence of a flame has been checked through a digital input, the heating phase begins.

HEATING PHASE

The burner accelerates to the speed requested by the controller to heat the oven. This speed is calculated proportionally within the temperature band given by parameter b3 (chamber) or b10 (boiler). The speed can vary from a minimum of b1 (chamber) or b8 (boiler), to a maximum of b0 (chamber) or b7 (boiler).

11.2.1 Hall sensor (b16)

The burner speed is always measured by the Hall sensor and is used as feedback.

The Hall sensor can be disabled by setting parameter b16 = 0: in this case the checks on the burner speed feedback and the pre-ventilation and ignition phases are skipped; the output PWM signal alone will be managed.

11.2.2 Flame presence (b17)

The presence of the flame is tested through a digital input; this check can be disabled by setting parameter b17 = 0. The adjustment behaves as if the flame were always present.

11.2.3 Burner fault (b15)

In the event that the burner fault signal is activated, parameter b15 establishes the status to be assigned to either the chamber or the boiler output:

0 = OFF The output is deactivated and the control unit is switched off.

1 = ON The output remains active and the control unit can carry out the reset procedure.

11.2.4 Error management

If no flame is detected during the ignition phase (only if b17=1), the burner stays at ignition speed.

If no flame is detected during the heating phase (only if b17=1), the activation relay is switched off, the burner returns to the ignition speed for 10 seconds and after 20 seconds another attempt is made to switch it on.

When the burner control unit activates the burner fault digital input, a reset procedure is carried out in which the reset relay is activated to send a reset pulse to the burner. Three attempts are made to reset the burner, and then the "Chamber/Boiler Flame Fault" alarm is activated. Heating is suspended until the alarm has been reset. The output status is then set to parameter b15.

The burner speed is checked by the Hall input (only if b16=1), and if the speed set for the chamber burner differs from the actual speed by a value higher than parameter b5 for a period longer than parameter b6, the "Chamber burner" alarm is activated. When the speed set for the boiler burner differs from the actual speed, by a value higher than parameter b12 for a period greater than parameter b13, the "Boiler burner" alarm is activated. Heating is suspended until the alarm has been reset.

The "Chamber Burner" and "Boiler Burner" alarms are activated after 5 seconds if the Hall input (only if b16=1) fails to receive any feedback speed.

11.3 On-off atmospheric burner management

When the oven receives a request to heat, the output (chamber or boiler) is activated by a command to the control unit that automatically manages the burner.

Atmospheric burners have no controls relating to the centrifugal fan, so the PWM output and the Hall input are not managed.

11.3.1 Flame presence (b17)

A digital input is used to test for the presence of a flame. This check can be disabled by setting parameter b17 = 0: in this instance the regulating process behaves as if the flame were always present.

11.3.2 Burner fault (b15)

In the event that the burner fault signal is activated, parameter b15 establishes the status to be assigned to either the chamber or the boiler output:

0 = OFF The output is deactivated and the control unit is switched off.

1 = ON The output remains active and the control unit can carry out the procedures.

11.3.3 Error management

If no flame is detected during the heating phase (only if b17=1), the activation relay is switched off, and after 30 seconds another attempt is made to switch it on.

The burner control unit automatically carries out the reset procedure, therefore when the burner fault digital input is activated, the "Chamber/Boiler Flame Fault" alarm is activated immediately. Heating is suspended until the alarm has been reset. The output status is then set to parameter b15.

The burner speed is not monitored and so there are no "Chamber Burner" or "Boiler Burner" alarms

11.4 Electrical connection

Example for Vcolor 368L.

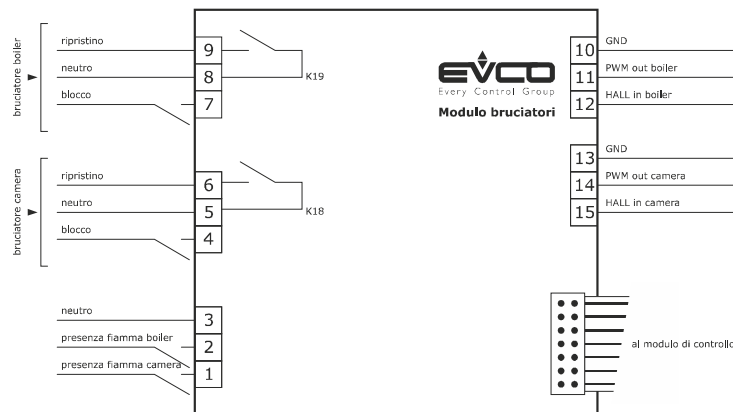

11.5 Application diagram

The EVCLE302XXE burner module interacts with electronic ignition circuit boards for Honeywell series 4565 and similar atmospheric burners and with variable speed centrifugal fans with PWM control + feedback.
 Example for Vcolor 368L.

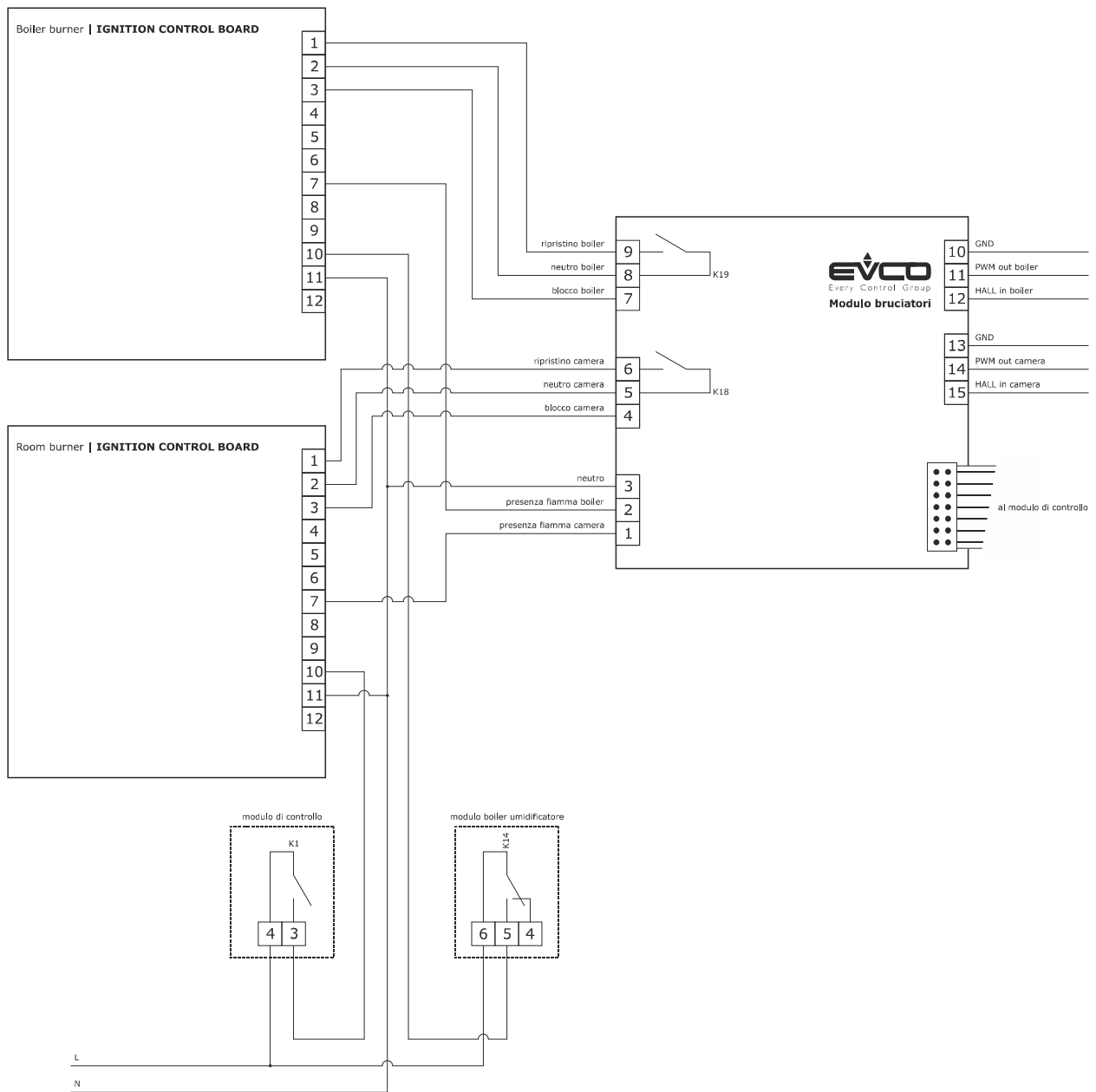

12 MANAGING THE LOADS

12.1 Temperature regulation

Depending on the value of parameter r13, temperature regulation can be ON-OFF or PI (Proportional-Integral).

NB: PI regulation is available only for electric ovens.

If ON-OFF regulation is active, the output is on until the chamber temperature reaches the working setpoint and it switches on again whenever the temperature falls below the level set in parameter r0 (i.e. "working setpoint - r0").

Where PI regulation is active, parameters r0, r14, r15 and r16 come into play.

12.2 Steam injection

The steam generation method depends on parameter t0, as follows:

- if parameter t0 is set at 0, steam will be generated directly
- if parameter t0 is set at 1, steam will be generated by an external humidifier
- if parameter t0 is set at 2, steam will be generated in combined mode (i.e. both directly and with an external humidifier); in this case the temperature set by parameter t12 determines the temperature above which steam will be injected directly and below which steam generated by an external humidifier will be injected (according to the temperature detected by the chamber probe).

Steam can also be injected manually by keeping the  icon pressed.

12.3 Venting

The load managed by the venting output depends on the parameter u1 settings, as follows:

- if parameter u1 is set at 0, the load will be an on/off solenoid valve
- if parameter u1 is set at 1, the load will be a "FIMAR" motorised solenoid valve.

It is possible to establish the behaviour of the vent during the cooking cycles, i.e. whether the vent should remain closed or open or if it should open x minutes before the end of the phase in progress.

The vent is automatically opened at the end of a cooking cycle, but it can be activated manually at any time during the cooking cycle by pressing the  icon.

12.4 Chamber light

The chamber light is switched on and off by touching the relevant area: 

12.5 Electronics compartment fan

The electronics compartment fan is always switched on and remains on even when set to OFF if the board temperature is greater than F6-F7.

To set the configuration parameters, see section 13.

12.6 Fan

The fan management type depends on parameter F0, as follows:

- if parameter F0 is set at 0, the fan will operate in "on/off" and single speed mode
- if parameter F0 is set at 1, the fan will operate in "on/off" and single speed mode and with inversion of the fan direction
- if parameter F0 is set at 2, the fan will operate in "on/off" and two-speed mode and with inversion of the fan direction
- if parameter F0 is set at 3, the fan will operate in modulating mode and with inversion of the fan direction

If parameter F0 is set at 0, 1 or 2, parameter F1 will set the time the fan is switched off for the purpose of direction inversion and F2 will set the time the fan is switched on for each direction.

If parameter F0 is set at 3, parameters F4 and F5 will set the minimum and maximum fan speeds, parameter F8 will control the minimum fan speed that can be set for the cooking cycles.

12.7 Fume reduction

To enable the fume reduction function, parameter P3 must be set to 1 and the fan speed must not be set to double speed (f0 ≠ 2).

The fume reduction function is activated until the temperature detected by the fume probe reaches the temperature set by parameter t13 and is switched off again whenever the temperature falls below that set by parameter t14 (i.e. "t14 - t13") only if the fume probe is enabled (i.e. if parameter P3 is set to 1).

To set the configuration parameters, see section 13.

12.8 Managing outputs for special washing cycles

The controller has 4 relay outputs designed to manage two different types of wash:

- **Washing with liquid detergent**, without recirculation of the water
- **Washing with tablet detergent**, with recirculation of the water

At the start of each washing cycle the chamber light will automatically switch on; it can be switched off or on again at any time by

means of the dedicated  button.

The type of wash can be selected using parameter w17.

12.8.1 Washing with liquid detergent, without recirculation of the water (W17 = 1)

There are 4 management relays, each of which has a different function:

- **Relay K10**: Mains water solenoid valve;
- **Relay K11**: Liquid detergent dispensing pump;
- **Relay K12**: Water discharge pump;
- **Relay K13**: Liquid rinse aid dispensing pump.

The washing cycle takes place in 5 sequential phases.

Phase 1 - Prewash:

The temperature of the oven is adjusted to the prewash temperature (parameter w0). If the chamber temperature is lower (**w0-w1**), the heating output will be activated together with the fan, and at the same time the vent will be closed.

If instead, the temperature is higher than that required, the controller will keep only the fan active, the vent outlet will remain open and a pop-up message will request that the door be opened in order to speed up the cooling of the chamber.

When the temperature falls within the setpoint band "*prewash (w0) - prewash activation consent hysteresis (w1)*", the vent closes fully, a request is made for the door to be closed (if previously open) and the controller will activate relay K10 (mains water solenoid valve) and relay K12 (water discharge pump) for w2 minutes.

The fan remains active for the entire phase, and the heating output will keep the temperature at the preset level.

At the end of the time w2, the heaters, the fan and the water solenoid valve will be deactivated and after a delay time w16 the water discharge pump will also be deactivated.

Phase 2- Washing:

Once the prewash phase has been completed, the washing phase begins, in which relay K11 (liquid detergent dispensing pump) is activated for a time of w4 seconds. If w20 = 1, the injection output and the water solenoid valve relay will both be activated.

Once the time set in w4 has passed, there will be a pause of w5 minutes to allow the detergent to act.

At the end of the time set by w5, the machine resumes heating with the fan active until the chamber is at the washing temperature (parameter w3). Once the time set at t11 has elapsed, the controller will begin to inject steam into the chamber (with a regulation equal to 100%) for a total time of w6 minutes. Once the w6 time has elapsed, the controller performs a brief rinsing of the chamber, activating the K10 relays (mains water solenoid valve) and K12 (washing liquid discharge) for w7 seconds.

At the end of the time w7, the water solenoid valve will be deactivated and after a delay time w16 the water discharge pump will also be deactivated.

Washing phase 2 will be carried out up to a maximum of 3 times in accordance with the washing intensity set by the final user during the cycle selection/setting phase:

- once (soft wash)
- twice (medium wash)
- 3 times (hard wash)

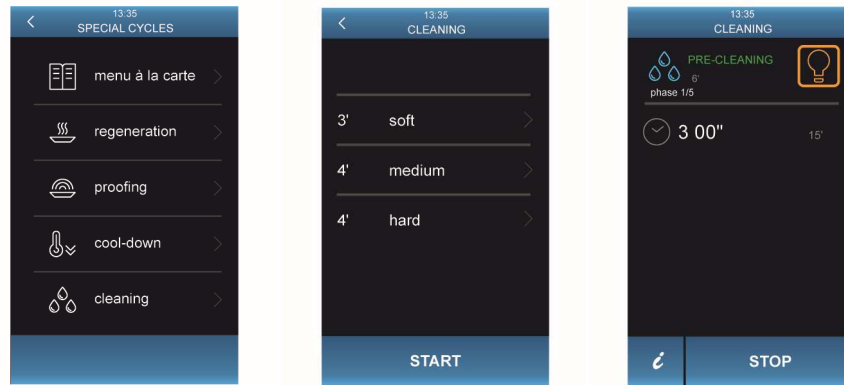

Phase 3 - Rinse aid:

Once the washing is completed, the "rinse aid" phase begins.

The K13 relay, "liquid rinse aid dispensing pump" is activated for w9 seconds. If w20 = 1, the injection output and the water solenoid valve relay will both be activated. At the end of the w9 time, there will be a pause of w10 minutes to allow the rinse aid to act.

Once the time set at w10 has elapsed, the machine resumes heating with the fan active until the chamber is brought to the rinse aid action temperature (parameter w8). Once the time set at t11 has elapsed, the controller will begin to inject steam into the chamber with a regulation equal to 100% for a time of w11 minutes.

N.B.: if w9=0, the "rinse aid" phase will be skipped totally.

Phase 4 - Rinsing:

After the "rinse aid" phase, the rinsing phase begins: the machine (with fan activated) is brought to the rinsing temperature (parameter w12); the controller will activate the K10 relay (mains water solenoid valve) and at the same time the K12 relay will be activated (water discharge pump) for w13 minutes.

The fan remains active for the entire phase, and the heating output keeps the temperature at the preset level.

Once the time set at w13 has elapsed, the mains water solenoid valve will be deactivated as will the water discharge pump after a delay time w16.

Phase 5 - Drying:

Once the rinsing phase has finished, the drying phase begins: the machine (with fan activated) is brought to the drying temperature (parameter w14), after which the vent is opened and the temperature is maintained for w15 minutes. Once this time period has elapsed, the washing will end, all the outputs will be switched off, including the chamber light, and the machine will return to the ON screen.

Suspension of the washing cycle:

If the cycle is halted manually during the pre-wash, rinsing or drying phases, it will be suspended immediately.

If the cycle is halted manually during the washing or rinse aid phases, it will move on to the rinsing phase at the end of which it will stop.

During any of the phases the power failure alarm will cause the phase to restart from the beginning.

If the door is opened during any of the phases, the cycle will be suspended and will then resume when the door is closed.

12.8.2 Washing with tablet detergent, with recirculation of the water (W17 = 2)

There are 4 management relays with the following dedicated functions:

K10 Relay:	solenoid valve supplying mains water to the condenser
K11 Relay:	water recirculation pump
K12 Relay:	condenser water discharge pump
K13 Relay:	unused

This type of washing can also make use of a probe dedicated to monitoring the discharge temperature of the water used for washing since the water temperature normally should not exceed 60-75°C in order for it to be discharged into the sewers (state regulation).

To enable monitoring of the discharge water temperature, the appropriate probe must be enabled (as an alternative to the fume probe) with parameter P3= 2.

Washing using tablets involves selecting 4 different types of cycle:

- Rinsen
- SOFT wash
- MEDIUM wash
- HARD wash

The "Rinsen" wash type is a cycle with a special sequence; the other types of cycle differ in the number of repetitions of the washing phase carried out.

The following illustration shows the "WASH" selection screen, from which one of the four types of washes can be chosen.

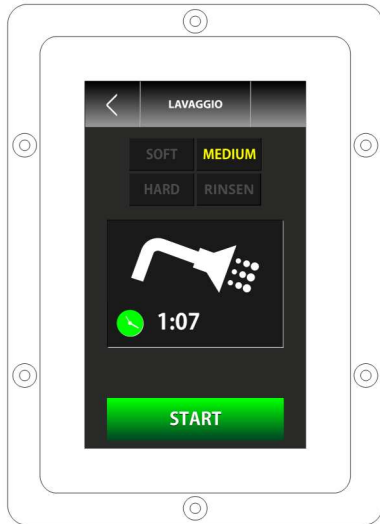

Cycle selection and start

When a RINSEN cycle is selected, it immediately starts with a pre-wash phase.

Whereas if one of the other three types of wash is selected, the controller immediately requests the addition of the appropriate number of doses of detergent into the chamber:

- 2 doses = SOFT wash
- 4 doses = MEDIUM wash
- 6 doses = HARD wash

Once the detergent has been added (the machine carries out no checks that the detergent has actually been added), pressing the START key again starts the machine in a pre-wash phase.

Phase 1 - Prewash:

The temperature of the oven is adjusted to the prewash temperature (parameter w0). If the chamber temperature is lower, the heating output will be activated together with the fan, and at the same time the vent will be closed.

If instead, the temperature is higher than that required, the controller will keep only the fan active, the vent outlet will remain open and a pop-up message will request that the door be opened in order to speed up the cooling of the chamber.

When the temperature falls within the setpoint band "**prewash (w0) - prewash activation consent hysteresis (w1)**", the vent is fully closed, a request is made for the door to be closed (if previously open) and the controller will activate the **K10 relay (mains water solenoid valve)** for **w2** minutes during which the condenser will be filled with water to allow the recirculation pump to draw water for the various washing phases.

The fan remains active for the entire phase, and the heating output keeps the temperature at the preset level.

Once the time set at **w2** has elapsed, operation of the machine will vary depending on the type of cycle selected: RINSEN or WASHING cycle.

Phase 2A – Rinsen

When the pre-wash (Rinsen) phase has completed, the selected cycle will be carried out.

A count of a w10 minute cycle is started during which the "solenoid valve supplying mains water to the condenser", "direct steam injection" and "water recirculation pump" outputs are activated with the fan activated at maximum speed.

Once the w10 time count is completed, the machine will return to the HOME screen keeping the "Water Discharge Pump" output running for the time w9 in order to empty the condenser.

If the door should be opened or the STOP button pressed, the cycle will stop immediately and the screen will return to the HOME page.

Phase 2B - Washing Preparation

The oven is adjusted to the "Washing Preparation" temperature (parameter **w8**) with humidification at 100% for **w11** minutes, during which the **K10** relay (**solenoid valve supplying mains water to the condenser**) is also activated.

Once the temperature has been reached, all the outputs with the exception of the fan, will shut off, until the temperature has dropped below the **w8-w18** temperature with regulation of the steam injection and mains water supply being restored. Once the time set at w11 has elapsed, the cycle progresses to the next phase.

Phase 3B - Washing

Once the "Washing Preparation" phase is completed, the cycle will move on to the "Washing" phase.

The washing phase starts with a time w5 during which the oven is brought to the washing temperature (parameter w3), the fan is permanently active at maximum speed, and the recirculation pump is activated in order to transfer hot water from the condenser into the chamber passing it through the detergent tablets.

No steam is used in this phase.

Following w5, a time w6 is set during which the machine deactivates all functions (except the light) to enable the detergent to act.

The washing phase will be repeated:

- **3 times** when carrying out a **SOFT** washing cycle;
- **6 times** when carrying out a **MEDIUM** washing cycle;
- **9 times** when carrying out a **HARD** washing cycle.

Throughout the washing phase, if enabled through parameter P3 and if the value of the water discharge probe is greater than the maximum water discharge setpoint (parameter w19), the controller will activate the mains water filling output to allow the temperature in the condenser to fall.

The differential of this regulation is fixed at -10°C, i.e. the water intake is halted when the temperature read by the **Water Discharge** probe falls 10°C below the maximum water discharge setpoint (parameter w19).

At the end of the number of cycles provided for, the next phase will begin.

Phase 4B - Rinsing

This phase lasts for a time w13 during which the condenser mains water supply, the direct steam injection and the fan at maximum speed will be activated.

It does not involve any heating or recirculation. Once the time set at w13 has elapsed, the cycle progresses to the next phase.

Phase 5B - Drying

Once the rinsing phase is completed, the drying phase begins.

The machine is brought to the drying temperature (parameter **w14**) with the fan activated at maximum speed for **w15** minutes, at the end of which the water discharge pump will be activated for **w9**. The cycle will then end and the machine will return to the HOME screen.

Suspension of the washing cycle

If the cycle is halted manually during phases 1, 2A, 2B or 5B, washing will be suspended immediately.

If the cycle is halted manually during phase 3B, it will move on to phase 4B, at the end of which it will stop. If, instead, the cycle is halted manually during phase 4B, the cycle will complete the phase in progress and then stop.

If the door is opened during any phase, the cycle will not be interrupted but all the outputs involved in regulation will be deactivated.

During any of the phases the power failure alarm will cause the phase in progress to restart from the beginning.

13 EPOCA CLOUD PLATFORM

EPoCA is a remote monitoring system based on a cloud platform. All that is needed is a simple onsite Wi-Fi internet connection to enable the controller, using EVlink Wi-Fi module, to connect to the cloud system, making it possible to remotely manage equipment from a PC, tablet or smartphone.

The responsive design and the graphic interface conceived to provide a pleasant user experience make EPoCA a ready-to-use solution for easily accessible monitoring operations, even for entry-level users, while offering all the typical functions of professional platforms. With appropriate protection measures for access and data, the system makes it possible for one or more enabled users to operate remotely on the unit to configure its parameters, view HACCP data (also in graphic form) and to download records in the most popular formats, such as XLSX, CSV and PDF. The functions playing a key role include alarm warnings sent automatically by the system to selected e-mail addresses.

Schematic diagram:

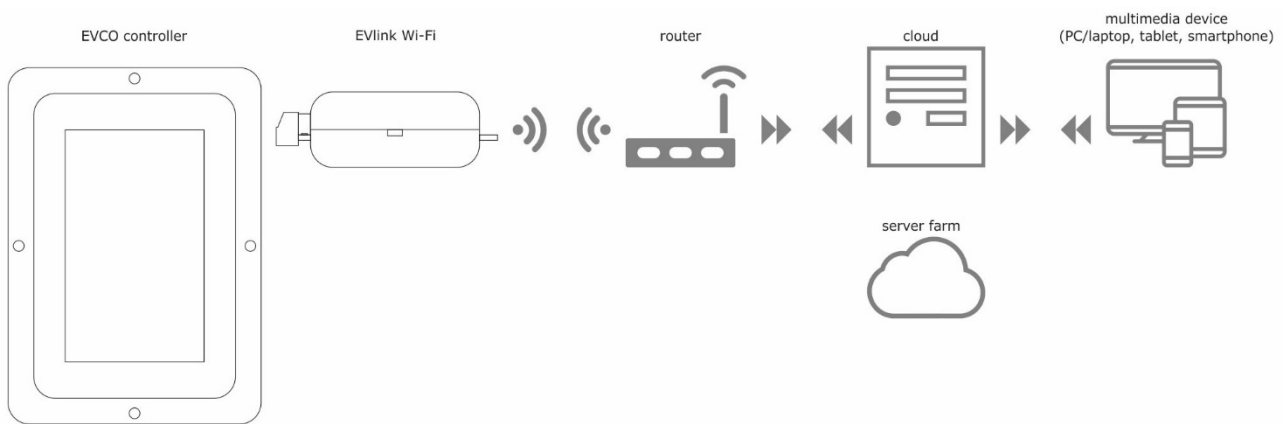

For more details on the EVlink Wi-Fi module and on the EPoCA cloud platform, please check out the "EPoCA" manual in our website www.evco.it.

14 LIST OF CONFIGURATION PARAMETERS

The table below describes the configuration parameters of the device.

PARAM.	MIN.	MAX.	U.M.	DEF.	ANALOGUE INPUTS
P0	0	2	- - -	0	Type of probe 0 = J thermocouple (only for J/K versions) 1 = K thermocouple (only for J/K versions) 2 = Pt 100 (only for Pt 100 versions)
P1	0	1	- - -	0	Temperature measurement unit (1) 0 = °C 1 = °F
P2	0	1	- - -	0	Enable needle probe 1 = yes
P3	0	2	- - -	0	Enable fume/condenser water discharge probe 0 = probe not enabled 1 = fume probe 2 = water discharge probe
P4	0	1	- - -	0	Enable boiler probe 1 = yes
CA1	-25/-50	25/50	°C/°F ⁽²⁾	0	Chamber probe offset
CA2	-25/-50	25/50	°C/°F ⁽²⁾	0	Needle probe offset
CA3	-25/-50	25/50	°C/°F ⁽²⁾	0	Fume probe offset
PARAM.	MIN.	MAX.	U.M.	DEF.	MAIN REGULATOR
r0	1	99	°C/°F ⁽²⁾	5	If r13 = 0 working setpoint differential (referring to the temperature detected by the chamber probe) If r13 = 1 proportional band for adjusting PI
r1	0	r2	°C/°F ⁽²⁾	40	Minimum working setpoint (referring to the temperature detected by the chamber probe) for Mixed cooking type
r2	r1	500	°C/°F ⁽²⁾	150	Maximum working setpoint (referring to the temperature detected by the chamber probe) for Mixed cooking type
r3	r1	r2	°C/°F ⁽²⁾	130	Working set-point for factory setting (referring to the temperature detected by the chamber probe). See also r0
r4	0	r5	°C/°F ⁽²⁾	0	Core temperature minimum setpoint (referring to the temperature detected by the needle probe)
r5	r4	500	°C/°F ⁽²⁾	100	Core temperature maximum setpoint (referring to the temperature detected by the needle probe)
r6	r4	r5	°C/°F ⁽²⁾	30	Core temperature working setpoint for factory setting (referring to the temperature detected by the needle probe)
r7	0	r8	°C/°F ⁽²⁾	0	Delta T minimum setpoint (referring to the temperature detected by the needle probe)
r8	r7	150	°C/°F ⁽²⁾	30	Delta T maximum setpoint (referring to the temperature detected by the needle probe)
r9	r7	r8	°C/°F ⁽²⁾	5	Delta T setpoint for factory setting (referring to the temperature detected by the needle probe)

r10	-199	199	°C/°F ⁽²⁾	10	Working setpoint during pre-heating (referring to the working setpoint during the first cooking cycle phase, i.e. "working setpoint during the first cooking cycle phase + r10"; referring to the temperature detected by the chamber probe). See also parameter r0
r11	0	500	°C/°F ⁽²⁾	50	Working setpoint during cooling (referring to the temperature detected by the chamber probe)
r12	0	240	min	240	Duration of a power failure during the cooking cycle sufficient to interrupt it (3) 0 = always interrupts cooking
r13	0	1	---	0	Type of temperature regulation 0 = ON-OFF 1 = PI (Proportional-Integral), FOR ELECTRIC OVENS ONLY
r14	60	999	s	180	Minimum time between two consecutive output switch-ons for temperature regulation (only valid if r13 = 1)
r15	10	240	s	10	Minimum on/off duration of the output for temperature regulation (only valid if r13 = 1)
r16	0	240	min	30	Integral time (only valid if r13 = 1), 0 = the integral time for the PI adjustment is disabled
r17	0	r2	°C/°F ⁽²⁾	50	Minimum working setpoint (referring to the temperature detected by the chamber probe) for Convection cooking type
r18	r1	500	°C/°F ⁽²⁾	300	Maximum working setpoint (referring to the temperature detected by the chamber probe) for Convection cooking type
r19	0	r2	°C/°F ⁽²⁾	30	Minimum working setpoint (referring to the temperature detected by the chamber probe) for Steam cooking type
r20	r1	500	°C/°F ⁽²⁾	90	MAXIMUM working setpoint (referring to the temperature detected by the chamber probe) for Steam cooking type
PARAM.	MIN.	MAX.	U.M.	DEF.	MISCELLANEOUS
c0	-1	120	s	10	Length of time buzzer sounds on completion of the cooking cycle 0 = no buzzer or pop-up -1 = until silenced manually
c1	0	1	---	0	Sounding of buzzer (for 1 second) at the end of a cooking cycle phase 0 = NO 1 = YES
c2	0	240	min	60	Time that has to pass if no action is taken on the device (from when the "weekly programmed switch-on" function is activated) in order for it to switch off, only if pre-heating is enabled
c3	0	99	°C/°F ⁽²⁾	10	Temperature above which the temperature detected by the chamber probe cannot be displayed (referring to the working setpoint, i.e. "working setpoint + c3") 0 = function absent
c4	0	99	°C/°F ⁽²⁾	10	Temperature below which the temperature detected by the chamber probe cannot be displayed (referring to the working setpoint, i.e. "working setpoint - c4") 0 = function absent
PARAM.	MIN.	MAX.	U.M.	DEF.	FAN
F0	0	3	---	0	Fan management type 0 = in "on/off" and single speed mode 1 = in "on/off" and single speed mode and with inversion of the fan direction

					2 = in "on/off" and two-speed mode and with inversion of the fan direction 3 = in modulating mode and with inversion of the fan direction
F1	5	120	s	15	Time the fan is switched off for the purpose of direction inversion (only if F0 = 1, 2 or 3). See also F2
F2	5	600	s	120	Time the fan is switched on in each direction (only if F0 = 1, 2 or 3); see also F1
F3	0	1	- - -	0	Temperature regulation output switch off during the fan switch off for the purpose of direction inversion (only if F0 = 1, 2 or 3) 0 = YES 1 = NO NB: only if PI regulation of the chamber is not enabled
F4	0	F5	%	0	Minimum fan speed (meaning the percentage of the maximum speed; only if F0 = 3)
F5	F4	100	%	100	Maximum fan speed (meaning the percentage of the maximum speed; only if F0 = 3)
F6	20/65	65/150	°C/°F (2)	60	Temperature above which the electronics compartment fan continues to run on entering Stand-by (referring to the operating temperature of the control module); see also F7
F7	1	99	°C/°F (2)	10	F6 differential
F8	0	100	%	10	Minimum fan speed that can be set by the user (meaning the percentage of the maximum speed; only if F0 = 3)
PARAM.	MIN.	MAX.	U.M.	DEF.	STEAM INJECTION
t0	0	2	- - -	0	Steam generation mode 0 = direct 1 = with an external humidifier 2 = combined (both directly and with an external humidifier)
t1	t2	999	s	60	Cycle time for injection of steam generated directly (only for Mixed cooking type) If t1=1000, a single injection will take place at the start of the cycle
t2	0	t1	s	30	Duration of injection of steam generated directly to obtain maximum humidification (only for Mixed cooking type)
t3	0	999	s	60	Delay of injection of steam generated directly from the start-up of a cooking cycle phase 0= the controller manages chamber humidification at the humidity value set for the first cooking cycle phase, also during pre-heating
t4	0	1	- - -	0	Enable constraint between injection of steam generated directly and the fan 0 = NO 1 = YES – injection stops when the fan switches off. If the fan is off when the steam is to be injected, it will be injected the next time the fan is on and if the fan should be switched off during steam injection, switch off will take place when the injection is completed
t5	0	1	- - -	0	Enable constraint between injection of steam generated directly and the temperature regulation output 0 = NO 1 = YES - If the output is off when the steam is to be injected, it will be injected the next time the output is on and if the output should be switched off during steam injection, switch off will take place when the injection is completed
t6	t7	999	s	60	Cycle time for injection of steam generated by an external humidifier

					(for Mixed cooking type)
t7	0	t6	s	30	Duration of injection of steam generated by an external humidifier to obtain maximum humidification (for Mixed cooking type)
t8	0	999	s	60	Delay of injection of steam generated by an external humidifier from the start-up of a cooking cycle phase 0 = the controller manages chamber humidification at the humidity value set for the first cooking cycle phase, also during pre-heating
t9	0	1	- - -	0	Enable constraint between injection of steam generated by an external humidifier and the fan 0 = NO 1 = YES - If the fan is off when the steam is to be injected, it will be injected the next time the fan is on and if the fan should be switched off during steam injection, switch off will take place when the injection is completed
t10	0	1	- - -	0	Enable constraint between injection of steam generated by an external humidifier and the temperature regulation output 0 = NO 1 = YES - If the output is off when the steam is to be injected, it will be injected the next time the output is on and if the output should be switched off during steam injection, switch off will take place when the injection is completed
t11	0	240	s	5	Delay of steam injection from switch on of the temperature regulation output or switch on of the fan
t12	0	500	°C/°F ⁽²⁾	120	Temperature above which directly generated steam injection is activated and below which steam generated by an external humidifier is injected (referring to the temperature detected by the chamber probe; only if t0 = 2)
t13	0	500	°C/°F ⁽²⁾	90	Temperature above which fume reduction is activated (referring to the temperature detected by the fume probe; only if F0 other than 2); see also t14
t14	1	99	°C/°F ⁽²⁾	5	t13 differential
t15	0	1	---	0	Enable boiler expansion 0 = NO 1 = YES
t16	1	500	°C/°F ⁽²⁾	80	Boiler temperature above which boiler steam injection is enabled
t17	1	500	°C/°F ⁽²⁾	95	Boiler steam working temperature
t18	1	500	°C/°F ⁽²⁾	70	Boiler steam maintenance temperature
t19	1	99	°C/°F ⁽²⁾	2	Differential for t17, t18
t20	0	240	s	2	Delay in boiler water loading stop
t21	0	240	min	2	Delay in boiler water discharge stop
t22	0	240	min	25	Phase 1 descaling agent action time for Washing
t23	1	500	°C/°F ⁽²⁾	60	Phase 1 descaling agent action temperature for Washing
t24	0	240	min	20	Phase 2 washing action time
t25	1	500	°C/°F ⁽²⁾	60	Phase 2 washing action time
t26	1	10	---	3	Phase 2 number of washes
t27	0	240	s	5	Alarm activation delay for water at minimum level
t28	0	240	min	3	Alarm activation delay for water at maximum level

t29	0	1	- - -	0	Humidification value display 0 = percentage (gastronomy ovens) 1 = in seconds (bread/pastry ovens)
t30	0	1	- - -	0	Enable constraint between injection of generated steam and the vent 0 = NO 1 = YES - vent open, no steam
t31	0	240	s	10	Constraint between steam injection and fans (heating) only if a single injection in a bread type oven (t1=1000) If = 0, no link between injection and fans If ≠ 0, the fans switch off when steam injection begins and remain off for a period of t31 after completion of the steam injection
t32	0	t33	%	20	Minimum humidity setpoint for Mixed cooking type
t33	t32	100	%	80	Maximum humidity setpoint for Mixed cooking type
t34	0	t35	%	50	Minimum humidity setpoint for Steam cooking type
t35	t34	100	%	100	Maximum humidity setpoint for Steam cooking type
t36	t37	999	s	60	Cycle time for injection of steam generated directly (for Steam cooking type)
t37	0	t36	s	30	Duration of injection of steam generated directly to obtain maximum humidification (for Steam cooking type)
t38	t39	999	s	60	Cycle time for injection of steam generated by an external humidifier (for Steam cooking type)
t39	0	t38	s	30	Duration of injection of steam generated by an external humidifier to obtain maximum humidification (for Steam cooking type)
t40	0	3	---	0	Boiler water level inputs 0 = minimum level and maximum level 1 = minimum level only 2 = without level inputs (NB: no boiler washing/rinsing)
PARAM.	MIN.	MAX.	U.M.	DEF.	TEMPERATURE ALARMS
A0	1	99	°C/°F (2)	10	A1 differential
A1	0	500	°C/°F (2)	0	Temperature above which the maximum temperature alarm is raised (referring to the temperature detected by the chamber probe); see also A0 and A3
A2	0	240	min	0	Maximum temperature alarm delay
A3	0	2	- - -	0	Type of maximum temperature alarm 0 = alarm absent 1 = absolute (A1) 2 = relative to the working setpoint (i.e. "working setpoint + A1")
A4	0	80/175	°C/°F (2)	70	Temperature above which the working temperature alarm is raised (referring to the working temperature of the control module) 0 = alarm absent
PARAM.	MIN.	MAX.	U.M.	DEF.	DIGITAL INPUTS
i0	0	1	- - -	0	Door switch input contact type 0 = normally open (input active with contact closed) 1 = normally closed (input active with contact open)

i1	0	1	- - -	0	Fan thermal switch input type 0 = normally open (input active with contact closed) 1 = normally closed (input active with contact open)
i2	0	1	- - -	0	Unused
i3	0	1	- - -	0	Safety thermal switch input type 0 = normally open (input active with contact closed) 1 = normally closed (input active with contact open)
i4	0	1	- - -	0	Power input contact type 0 = normally open (input active with contact closed) 1 = normally closed (input active with contact open)
PARAM.	MIN.	MAX.	U.M.	DEF.	DIGITAL OUTPUTS
u0	0	1	- - -	0	Venting output contact type 0 = normally open (venting open with contact closed) 1 = normally closed (venting open with contact open)
u1	0	1	- - -	0	Load managed by venting output 0 = <u>ON/OFF SOLENOID VALVE</u> 1 = <u>MOTORIZED SOLENOID VALVE</u> - with this setting parameters u2, u3 and u4 are relevant
u2	0	600	ds (s/10)	120	Duration of the venting output stoppage from the end of the short pulse for opening the vent and from the end of the long pulse for closing it (only if u1 = 1). See also u3 and u4
u3	0	600	ds (s/10)	10	Duration of the short pulse for closing the vent (only if u1 = 1); see also u2 and u4
u4	0	600	ds (s/10)	30	Duration of the long pulse for opening the vent (only if u1 = 1); see also u2 and u3
u5	0	600	ds (s/10)	75	Unused
PARAM.	MIN.	MAX.	U.M.	DEF.	SERIAL NETWORK
LA	1	247	- - -	247	Device address
Lb	0	3	- - -	2	Baud rate 0 = 2,400 baud 1 = 4,800 baud 2 = 9,600 baud 3 = 19,200 baud
LP	0	2	- - -	2	Parity 0 = none 1 = odd 2 = even
PARAM.	MIN.	MAX.	U.M.	DEF.	HOOD
k0	0	0	- - -	0	Unused
k1	0	1	- - -	1	Unused
k2	0	100	s	10	Maximum duration of hood operation k2=0, hood switched off
k3	0	1	- - -	0	Unused

PARAM.	MIN.	MAX.	U.M.	DEF.	WASHING
w0	0	500	°C/°F ⁽²⁾	60	Working setpoint for prewash phase
w1	1	99	°C/°F ⁽²⁾	10	Prewash activation enable differential
w2	0	240	min	10	Prewash time
w3	0	500	°C/°F ⁽²⁾	70	Working setpoint for washing phase
w4	0	240	s	5	Liquid detergent dispensing time
w5	0	240	min	10	Liquid detergent action time Washing time (for washing with tablets)
w6	0	240	min	10	Steam injection time for liquid detergent action Detergent action time (for washing with tablets)
w7	0	240	s	10	Short rinse time
w8	0	500	°C/°F ⁽²⁾	70	Working setpoint for rinse aid phase Washing preparation working setpoint (for washing with tablets)
w9	0	240	s	5	Rinse aid dispensing time Water discharge pump activation time after end of cycle (for washing with tablets)
w10	0	240	min	10	Rinse aid action time RINSEN phase time (for washing with tablets)
w11	0	240	min	10	Steam injection time for liquid detergent action Washing preparation time (for washing with tablets)
w12	0	500	°C/°F ⁽²⁾	60	Rinsing phase working setpoint
w13	0	240	min	5	Rinsing phase duration
w14	0	500	°C/°F ⁽²⁾	100	Drying phase working setpoint
w15	0	240	min	10	Drying phase duration
w16	0	240	sec	15	Water discharge pump deactivation delay
w17	0	3	---	1	Washing type 0= disabled 1= with liquid detergent without recirculation 2= with detergent tablets and recirculation 3= unused
w18	r0	99	°C/°F ⁽²⁾	7	Enable band for activation of loads during the "2B-Washing Preparation" phase (for washing with tablets)
w19	0	500	°C/°F ⁽²⁾	70	Washing discharge probe setpoint (for washing with tablets)
w20	0	1	---	1	Detergent/rinse aid output action (only if w17=1) 0 = activation of a single relay 1 = combined with water solenoid valve relay
PARAM.	MIN.	MAX.	U.M.	DEF.	BURNERS
b0	2500	6000	RPM	5000	Chamber burner maximum RPM
b1	1500	4000	RPM	2500	Chamber burner minimum RPM

b2	1000	3000	RPM	1000	Chamber burner ignition RPM
b3	1	99	°C/°F (2)	10	Band for chamber temperature proportional regulation
b4	2	10	sec	3	Chamber ramp time
b5	200	1000	RPM	200	Chamber burner alarm RPM
b6	10	120	s	10	Chamber burner RPM alarm delay
b7	2500	6000	RPM	5000	Boiler burner maximum RPM
b8	1500	4000	RPM	2500	Boiler burner minimum RPM
b9	1000	3000	RPM	1000	Boiler burner ignition RPM
b10	1	99	°C/°F (2)	10	Band for boiler temperature proportional regulation
b11	2	10	s	3	Boiler ramp time
b12	200	1000	RPM	200	Boiler burner alarm RPM
b13	10	120	s	10	Boiler burner RPM alarm delay
b14	0	2	---	0	Oven type 0 = electric 1 = fan assisted gas 2 = static gas
b15	0	1	---	0	Burner status during fault 0 = off 1 = on
b16	0	1	---	1	HALL sensor 0 = none 1 = present
b17	0	1	---	1	Flame detection 0 = none 1 = present
b18	0	3	---	1	MODBUS burners number
PARAM.	MIN.	MAX.	U.M.	DEF.	MISCELLANEOUS
e0	0	1	---	1	Unused
e1	0	240	min	5	Unused
e2	0	1	---	0	Unused
e3	0	100	%	10	Temperature compatibility percentage for loading recipes in Multicook cooking
e4	0	100	%	20	Humidity compatibility percentage for loading recipes in Multicook cooking
e5	4	10	---	10	Number of trays for loading recipes in Multicook cooking
e6	0	240	min	5	HACCP sampling time 0=no sampling
e7	0	1	---	1	Chamber temperature recording 0= Chamber probe HACCP temperature

					1= Probe HACCP temperature displayed
e8	0	240	°C/°F ⁽²⁾	20	Chamber temperature cooling warning band while cooking
e9	0	2	---	0	Preset colour schemes 0= dark background, light text 1= light background, dark text 2= light background, red text
PARAM.	MIN.	MAX.	U.M.	DEF.	SERIAL COMMUNICATION
PA1	426	-99	999	----	EPoCA level 1 password
PA2	824	-99	999	----	EPoCA level 2 password
bLE	1	0	99	----	Serial port connectivity configuration 0 = free 1 = forced for EPoCA 2-99 = EPoCA local network address

Notes

- (1) Set the appropriate parameters for the regulators after setting parameter P1
- (2) The unit of measurement depends on parameter P1
- (3) If the power failure duration is lower than the time set by parameter r12, when power is restored the cycle will be restarted from the beginning of cycle in which the power failed.

15 USING THE USB PORT

15.1 Initial information

The USB port makes possible the following operations.

- Upload and download of the settings in the recipes of the "My Recipes" function and in the working cycles of the "Special Cycles" function (known as "programs" from here on)
- Upload and download of the settings in the configuration parameters.

These operations are guaranteed by using the EVUSB4096M USB device.

Uploading operations are only possible if the firmware of the device from which it originates and the firmware of the destination device are the same.

15.2 Uploading the program settings

The program settings can be uploaded as follows.

1. Ensure that the device is switched off and that no procedure is in progress.
2. Insert a USB flash drive containing a text document named "prog.txt" in the USB port of the device and wait for a few seconds.
3. Touch "UPLOAD PROGRAMS".
4. Touch  to confirm.
5. When the upload has finished remove the USB flash drive from the port of the device.

15.3 Downloading the program settings

The program settings can be downloaded as follows.

1. Ensure that the device is switched off and that no procedure is in progress.
2. Insert a USB flash drive in the USB port of the device and wait for a few seconds.
3. Touch "DOWNLOAD PROGRAMS".
4. Touch  to confirm.

15.4 Uploading the settings in the configuration parameters

The program settings can be uploaded as follows.

1. Ensure that the device is switched off and that no procedure is in progress.
2. Insert a USB flash drive containing a text document named "prog.txt" in the USB port of the device and wait for a few seconds.
3. Touch "UPLOAD PARAMETERS".
4. Touch  to confirm.
5. When the upload has finished remove the USB flash drive from the port of the device.

15.5 Downloading the settings in the configuration parameters

The program settings can be downloaded as follows.

1. Ensure that the device is switched off and that no procedure is in progress.
2. Insert a USB flash drive in the USB port of the device and wait for a few seconds.
3. Touch "DOWNLOAD PARAMETERS".
4. Touch  to confirm.

15.6 Download of HACCP data stored within the controller

If a USB flash drive is connected, in addition to the upload/download parameters and recipes, the item DOWNLOAD HACCP DATA also appears.

If the data download start date is entered, the stored data of the cooking cycles performed by the oven are written to a .CSV file.

The two parameters that govern the recording of HACCP data are as follows:

e6	0	240	min	5	HACCP sampling time 0=no sampling
e7	0	1	---	1	Chamber temperature recording 0= chamber probe current HACCP temperature 1= chamber probe HACCP temperature displayed (see display filter parameters)

16 ALARMS

16.1 Alarms

If an alarm happens the buzzer sounds and the display shows the  icon and a pop-up message with an alarm code. Touch the display near the centre to silence the buzzer and restore the normal view.

The table below shows the meaning of the device's various alarm codes.

ALARM CODE	DESCRIPTION
Chamber probe ALARM	<p>Chamber probe alarm</p> <p>To correct</p> <ul style="list-style-type: none"> - Check the type of probe; see parameter P0 - Check the device-probe connection - Check the chamber temperature <p>Main results</p> <ul style="list-style-type: none"> - If the alarm is raised when the device is on, it will not be possible to start up a cooking or washing cycle - If the alarm is raised during a cooking cycle, the cycle will be interrupted - The temperature regulation output will be switched off
Needle probe ALARM	<p>Needle probe alarm</p> <p>To correct</p> <ul style="list-style-type: none"> - As in the previous instance, but in relation to the needle probe <p>Main results</p> <ul style="list-style-type: none"> - If the alarm is raised when the device is on, it will not be possible to start up a Delta T and a core temperature cooking cycle - If the alarm is raised during a Delta T or core temperature cooking cycle, the cycle will be interrupted
Fume probe ALARM	<p>Fume probe alarm</p> <p>To correct</p> <ul style="list-style-type: none"> - As in the previous case, but working on the fume probe <p>Main results</p> <ul style="list-style-type: none"> - The fume reduction management output will be switched off
Power failure ALARM	<p>Power failure alarm</p> <p>To correct</p> <ul style="list-style-type: none"> - Check the device-power supply connection. <p>Main results</p> <ul style="list-style-type: none"> - If the alarm is raised when the device is switched on or off, the device will switch off once the power is restored - If the alarm is raised during a cooking cycle and the interruption lasts for a shorter time than that set by parameter r12, when power is restored the cycle will be resumed from the start of the phase in which the power failed (if the interruption lasts longer than the time set by parameter r12, the cycle will be interrupted when power is restored).

<p>Control module communicat. ALARM</p>	<p>User interface-control module communication alarm</p> <p>To correct</p> <ul style="list-style-type: none"> - Check the user interface-control module connection <p>Main results</p> <ul style="list-style-type: none"> - If the alarm is raised when the device is on, it will not be possible to start up a cooking cycle - If the alarm is raised during a cooking cycle, there will be no effect
<p>Chamber high temperature ALARM</p>	<p>Maximum temperature alarm</p> <p>To correct</p> <ul style="list-style-type: none"> - Check the temperature detected by the chamber probe. See parameters A0, A1 and A3 <p>Main results</p> <ul style="list-style-type: none"> - no effect
<p>Control module high temp. ALARM</p>	<p>Operating temperature alarm</p> <p>To correct</p> <ul style="list-style-type: none"> - Check the operating temperature of the control module; see parameter A4 <p>Main results</p> <ul style="list-style-type: none"> - If the alarm is raised when the device is on, it will not be possible to start up a cooking cycle - If the alarm is raised during a cooking cycle, the cycle will be interrupted - The vent will open, the electronics compartment fan will switch on and the remaining outputs will be switched off - If the board is switched off while the alarm is active, the alarm buzzer will sound
	<p>Door switch input alarm</p> <p>To correct</p> <ul style="list-style-type: none"> - Check the cause of the input activation; see parameter i0 <p>Main results</p> <ul style="list-style-type: none"> - If the alarm is raised during a cooking cycle, the temperature regulation output, the fan and the steam injection output will be switched off and the vent opened
<p>Fan thermal switch ALARM</p>	<p>Fan thermal switch input alarm</p> <p>To correct</p> <ul style="list-style-type: none"> - Check the cause of the input activation; see parameter i1 <p>Main results</p> <ul style="list-style-type: none"> - If the alarm is raised during a cooking cycle, the temperature regulation output and the fan will be switched off
<p>Power consumption ALARM</p>	<p>Power input alarm</p> <p>To correct</p> <ul style="list-style-type: none"> - Check the cause of the input activation; see parameter i4 <p>Main results</p> <ul style="list-style-type: none"> - If the alarm is raised during a cooking cycle, the outputs will be switched off
<p>Boiler probe ALARM</p>	<p>Boiler probe alarm</p> <p>To correct</p> <ul style="list-style-type: none"> - Check the type of probe; see parameter P0 - Check the device-probe connection - Check the boiler temperature <p>Main results</p> <ul style="list-style-type: none"> - The boiler temperature regulation output will be deactivated

<p>Low water level ALARM</p>	<p>The boiler water does not reach the minimum level To correct - Check the boiler input; see parameter t27 Main results - The boiler temperature regulation output will be deactivated</p>
<p>Max water level ALARM</p>	<p>The boiler water does not reach the maximum level To correct - Check the boiler input; see parameter t28 Main results - The boiler temperature regulation output will be deactivated</p>
<p>Boiler discharge ALARM</p>	<p>Boiler discharge alarm To correct - Check the Min, Max H2O Boiler inputs; see parameter t21 Main results - The boiler temperature regulation output will be deactivated</p>
<p>Boiler module communicat. ALARM</p>	<p>Control module–boiler expansion module communication alarm To correct - Check the control module–boiler expansion module connection Main results - All the boiler regulations will be deactivated</p>
<p>Boiler safety switch ALARM</p>	<p>Boiler safety alarm To correct - Check the cause of the input activation Main results - All the boiler regulations will be deactivated</p>
<p>Chamber/boiler burner fault ALARM</p>	<p>Chamber/boiler burner fault alarm To correct - Check the cause of the burner fault Main results - The chamber/boiler burner will be deactivated</p>
<p>Chamber/boiler burner ALARM</p>	<p>Chamber/boiler burner alarm To correct - Check that the centrifugal fan is working properly, the feedback from the Hall sensor and parameters b5/b6 (chamber) or b12/b13 (boiler) Main results - The chamber/boiler burner will be deactivated</p>
<p>Control module compat. ALARM</p>	<p>User interface-control module compatibility alarm To correct - Check the user interface-control module FIRMWARE versions. Main results - The loads will be deactivated</p>

<p>Thermal switch ALARM</p>	<p>Safety thermostat input alarm To correct - Check the cause of the input activation; see parameter i3 Main results - if the alarm occurs during a cooking cycle, the cycle will be interrupted</p>
<p>Control module probe ALARM</p>	<p>Control module probe fault alarm To correct - turn the device off and on - check the temperature of the technical compartment Main results - the technical compartment fan will remain active</p>
<p>RTC</p>	<p>Real time clock alarm To correct: - set date and time</p>

When the cause of the error has been eliminated the device returns to normal working.

17 ACCESSORIES

17.1 EVlink Wi-Fi RS-485 module

Through the RS-485 communications port, the module provides the controller with Wi-Fi connectivity which enables remote management and monitoring from the Internet using the EPoCA cloud system.



17.2 Non-optoisolated RS-485/USB serial interface

The interface enables the device to be connected to the Parameters Manager set-up software system.



17.3 USB plug for panel installation

The plug makes the USB communications port of the device more accessible.

To connect the device to the plug, connecting cable 0810500018 or 0810500020 must be used (to be ordered separately).



17.4 Connecting cables 0810500018/0810500020

These cables are used to connect the USB plug for panel installation 0812000002 to the device.

Cable 0810500018 is 2 m long; cable 0810500020 is 0.5 m long.



17.5 4GB USB flash drive EVUSB4096M

The flash drive makes it possible to upload and download the settings and the data recorded by the device.



18 TECHNICAL SPECIFICATIONS

18.1 Technical specifications

Purpose of the control device	function controller		
Construction of the control device	built-in electronic device		
Container	user interface		control module
	black, self-extinguishing.		Open frame board
Measurements	user interface M	user interface L	control module
	Flush installation: 166,0 x 118,0 x 35,0 mm (6,535 x 4,645 x 1,377 in; L x H x D) Semi-recessed installation: 145,1 x 97,1 x 32,0 mm (5.712 x 3.822 x 1.259 in; L x H x D)	Flush installation: 216,0 x 156,0 x 50,0 mm (8,503 x 6,141 x 1,968 in; L x H x D). Semi-recessed installation: 192,9 x 131,9 x 47,0 mm (7.594 x 5.192 x 1.850 in; L x H x D)	113.5 x 255.0 x 33.0 mm (4.468 x 10.039 x 1.299 in; L x H x D).
Mounting methods for the control device	user interface		control module
	on the back of the panel, with threaded studs for a flush installation		On a flat surface with spacers.
Degree of protection	user interface		control module
	IP40		IP00
Connections	user interface		control module
	plug-in screw terminal blocks (control module and RS-485 MODBUS port), type A USB connector (USB port).		Plug-in screw terminal blocks (user interface, power supply, inputs and outputs).
	The maximum length of the connection cables of analogue inputs, digital inputs and analogue output must be lower than 10 m (32.808 ft). The maximum length of the connection cables of user interface-control module must be lower than 10 m (32.808 ft).		
Operating temperature	From 0 to 55 °C (from 32 to 131 °F)		
Storage temperature	From -10 to 70 °C (from 14 to 158 °F).		
Operating humidity	relative humidity without condensate from 10 to 90%		

Pollution status of the control device	2.	
Power supply:	user interface	control module
	provided by the control module	12 VAC ($\pm 15\%$), 50/60 Hz (± 3 Hz), 20 VA max.
Rated impulse-withstand voltage	4 KV	
Over-voltage category	III.	
Software class and structure	A.	
Clock	Built-in	
	Autonomy in the absence of a power supply: 24 hours with full charge.	
	Battery charging time: 2 min (the battery is charged by the power supply of the device).	
Analogue inputs	3 inputs (chamber probe, needle probe and fume probe) that can be set using the configuration parameter for the J/K thermocouples or the Pt 100 2-wire probes.	
	Thermocouple J type analogue inputs Sensor type: iron/constantan Measurement field: from -50 to 700 °C (from -58 to 1,292 °F). Resolution: 1 °C (1 °F). Protection: none.	
	Thermocouple K type analogue inputs Sensor type: chromel/alumel. Measurement field: from -50 to 1,100 °C (from -58 to 2,012 °F). Resolution: 1 °C (1 °F). Protection: none.	
Analogue inputs	Pt 100 type analogue inputs	
	Sensor type: Pt 100 class A. Measurement field: from -50 to 550 °C (from -58 to 1,022 °F). Resolution: 1 °C (1 °F). Protection: none.	
Digital inputs	5 inputs: - 1 (door switch), can be set using the configuration parameter for a normally open/normally closed contact (dry contact, 5 VDC, 0.5 mA) - 3 (fan thermal switch, thermal switch and power consumption), can be set using the configuration parameter for a normally open/normally closed contact (high voltage contact, 230 VAC)	

	<p>digital inputs for dry contact Power supply: none Protection: none</p> <hr/> <p>digital inputs for high voltage contact Power supply: 230 VAC. Protection: none.</p>
Analogue outputs	1 0-10 V output for fan management (in this case an external speed regulator should also be used).
Digital outputs:	<p>13 outputs (electro-mechanical relays):</p> <ul style="list-style-type: none"> - 1 1 A res. @ 250 VAC type SPST (K1) output for managing the chamber temperature regulation - 1 1 A res. @ 250 VAC type SPST (K2) output for managing the vent - 1 1 A res. @ 250 VAC type SPDT (K8) output for managing direct steam injection - 1 4 A res. @ 250 VAC type SPST (K9) output for managing the chamber light* - 1 1 A res. @ 250 VAC type SPST (K7) output for managing the electronics compartment fan - 1 1 A res. @ 250 VAC type SPST (K5) configurable output (for factory settings, for managing the anti-clockwise fan direction) - 1 1 A res. @ 250 VAC type SPST (K5) configurable output (for factory settings, for managing the clockwise fan direction) - 1 1 A res. @ 250 VAC type SPST (K3) configurable output (for factory settings, for managing the fan speed) - 1 1 A res. @ 250 VAC type SPST (K6) output for managing suction hood - 1 1 A res. @ 250 VAC type SPST (K10) configurable output (for factory settings, for managing the valve for the washing water) - 1 1 A res. @ 250 VAC type SPST (K11) configurable output (for factory settings, for managing the dispensing of liquid detergent for washing) - 1 1 A res. @ 250 VAC type SPST (K12) configurable output (for factory settings, for managing the discharge of liquid for the washing) - 1 1 A res. @ 250 VAC type SPDT (K13) configurable output (for factory settings, for managing the dispensing of rinse aid for washing) <p>The maximum permitted current on loads is 3 or 4 A (see the electrical connection diagram).</p> <p>* The relays do not control LED or fluorescent lights</p>
Displays	5 or 7-inch TFT touch-screen graphic display, 16K colours, 800 x 480 pixel resolution The presence of imperfection points on the display is within the tolerance limits as established by the reference standards.
Type 1 or Type 2 Actions	Type 1.
Additional features of Type 1 or Type 2 actions	C.

Communications ports	2 ports: - 1 RS-485 MODBUS port - 1 USB port
Warning and alarm buzzer	Built-in

Vcolor 368

Controller for combination ovens for gastronomy and pastry making

Installer manual ver. 3.0

PB - 19/21

Code 144VC368E304

This document and the solutions contained therein are the intellectual property of EVCO and thus protected by the Italian Intellectual Property Rights Code (CPI). EVCO imposes an absolute ban on the full or partial reproduction and disclosure of the content other than with the express approval of EVCO. The customer (manufacturer, installer or end-user) assumes all responsibility for the configuration of the device. EVCO accepts no liability for any possible errors in this document and reserves the right to make any changes, at any time without prejudice to the essential functional and safety features of the equipment.



EVCO S.p.A.
Via Feltre 81, 32036 Sedico Belluno ITALY
Tel. 0437/8422 | Fax 0437/83648
info@evco.it | www.evco.it